

COPYRIGHT

Fujitsu® PC Corporation has made every effort to ensure the accuracy and completeness of this document. However, as ongoing development efforts are continually improving the capabilities of our products, we cannot guarantee the accuracy of the contents of this document. We disclaim liability for errors, omissions, or future changes.

LifeBook, Fujitsu, and the Fujitsu logo are trademarks of Fujitsu Limited.

The following are registered trademarks of IBM Corporation: IBM, IBM PC AT, IBM PS/2.

The following are registered trademarks of Microsoft Corporation: MS, MS-DOS, Windows 95. PCMCIA is a trademark of the Personal Computer Memory Card International Association.

Phoenix and the Phoenix logo are registered trademarks of Phoenix Technologies, Ltd.

Pentium is a registered trademark and MMX technology is a trademark of Intel Corporation. PC-Doctor is a trademark of watergate.software.inc. SoftPEG is a registered trademark of

CompuCore Multimedia Inc.

LapLink is a registered trademark of Traveling Software Inc.

AudioRack is a registered trademark of ESS Technology, Inc.

MegaPhone is a registered trademark of Cypress Research Corporation

All other trademarks mentioned herein are the property of their respective owners.

We cannot guarantee the accuracy of the contents of this document. We disclaim liability for errors, omissions, or future changes.

© Copyright 1996 Fujitsu PC Corporation. All rights reserved. No part of this publication may be copied, reproduced, or translated, without prior written consent of Fujitsu PC Corporation. No part of this publication may be stored or transmitted in any electronic form without the written consent of Fujitsu PC Corporation.



DECLARATION OF CONFORMITY according to FCC Part 15

Responsible Party Name: Fujitsu PC Corporation

Address: 598 Gibraltar Drive
Milpitas, CA 95035

Telephone: (408) 935-8800

Declares that product: Model: LifeBook 735Dx.
LifeBook 755Tx.
LifeBook 765Tx.

Complies with Part 15
of the FCC Rules.

This device complies with Part 15 of the FCC rules. Operations is subject to the following two conditions: (1) This device must not be allowed to cause harmful interference, (2) This device must accept any interference received, including interference that may cause undesired operation.

David Woo
FULL NAME

Fujitsu
COMPANY

9/23/97
DATE



CAUTION

Changes or modification not expressly approved by Fujitsu PC Corporation could void this user's authority to operate the equipment.

FCC NOTICES

Notice to Users of Radios and Television

These limits are designed to provide reasonable protection against harmful interference in a residential installation. This equipment generates, uses, and can radiate radio frequency energy and, if not installed and used in accordance with the instructions, may cause harmful interference to radio communications. However, there is no guarantee that interference will not occur in a particular installation. If this equipment does cause harmful interference to radio or television reception, which can be determined by turning the equipment off and on, the user is encouraged to try to correct the interference by one or more of the following measures:

- Reorient or relocate the receiving antenna.
- Increase the separation between the equipment and receiver.
- Connect the equipment into an outlet that is on a different circuit than the receiver.
- Consult the dealer or an experienced radio/TV technician for help.

Shielded interconnect cables must be employed with this equipment to ensure compliance with the pertinent RF emission limits governing this device.

Notice to Users of the US Telephone Network
The LifeBook™ 700 Series notebook computers are supplied with an internal modem which complies with Part 68 of the FCC rules. On this notebook is a label that contains the FCC Registration Number and the Ringer Equivalence Number (REN) for this equipment among other information. If requested, the user must provide their telephone company with the following information:

1. The telephone number to which the notebook is connected.
2. The Ringer Equivalence Number (REN) for this equipment.
3. That the equipment requires a standard modular jack type USOC RJ-11C which is FCC Part 68 compliant.
4. The FCC Registration Number.

This equipment is designed to be connected to the telephone network or premises wiring using a standard modular jack type USOC RJ-11C which is FCC Part 68 compliant and a line cord between the modem and the telephone network with a minimum of 26AWG.

The REN is used to determine the number of devices that you may connect to your telephone line and still have all of those devices ring when your number is called. Too many devices on one line may result in failure to ring in response to an incoming call. In most, but not all, areas the sum of the RENs of all of the devices should not exceed five (5.0). To be certain of the number of devices you may connect to your line, as determined by the RENs, contact your local telephone company.

If this equipment causes harm to the telephone network, your telephone company may discontinue your service temporarily. If possible, they will notify you in advance. If advance notice is not practical they will notify you as soon as possible. You will also be advised of your right to file a complaint with the FCC.

This fax modem also complies with fax branding requirements per FCC Part 68.

Your telephone company will probably ask you to disconnect this equipment from the telephone network until the problem is corrected and you are sure that the equipment is not malfunctioning. This equipment may not be used on coin service telephones provided by your telephone company. Connection to party lines is subject to state tariffs. Contact your state's public utility commission, public service commission or corporation commission for more information.

This equipment includes automatic dialing capability. When programming and/or making test calls to emergency numbers:

- Remain on the line and briefly explain to the dispatcher the reason for the call.
- Perform such activities in off-peak hours, such as early morning or late evening.

FCC rules prohibit the use of non-hearing aid compatible telephones in the following locations or applications:

- All public or semipublic coin-operated or credit card telephones.
- Elevators, highways, tunnels (automobile, subway, railroad or pedestrian) where a person with impaired hearing might be isolated in an emergency.
- Places where telephones are specifically installed to alert emergency authorities such as fire, police or medical assistance personnel.
- Hospital rooms, residential health care facilities, convalescent homes and prisons.
- Workstations for the hearing impaired.
- Hotel, motel or apartment lobbies.
- Stores where telephones are used by patrons to order merchandise.

- Public transportation terminals where telephones are used to call taxis or to reserve lodging or rental cars.
- In hotel and motel rooms as at least ten percent of the rooms must contain hearing aid compatible telephones or jacks for plug-in hearing aid compatible telephones which will be provided to hearing impaired customers on request.

DOC (INDUSTRY CANADA) NOTICES

Notice to Users of Radios and Television
This Class B digital apparatus meets all requirements of the Canadian Interference-Causing Equipment Regulations.

CET appareil numérique de la class B respecte toutes les exigences du Règlement sur le matériel brouilleur du Canada.

Notice to Users of the Canadian Telephone Network

The Canadian Industry Canada label identifies certified equipment. This certification means that the equipment meets certain telecommunications network protective, operational and safety requirements. The Department does not guarantee the equipment will operate to the user's satisfaction.

The LifeBook 700 Series notebook computers are supplied with an internal modem which complies with the Industry Canada certification standards for telecommunication network protection and safety requirements. Before connecting this equipment to a telephone line the user should ensure that it is permissible to connect this equipment to the local telecommunication facilities. The user should be aware that compliance with the certification standards does not prevent service degradation in some situations.

Repairs to telecommunication equipment should be made by a Canadian authorized maintenance facility. Any repairs or alterations not expressly approved by Fujitsu™ PC Corporation or any equipment failures may give the telecommunication company cause to request the user to disconnect the equipment from the telephone line.

The connecting arrangement code for this equipment is CA11A.

The Load Number is 3.

The Load Number assigned to each telephone terminal device denotes the percentage of the total load to be connected to a telephone loop or circuit which is used by the device to prevent overloading. The termination on a loop may consist of any combination of devices such that the total of the load numbers of all devices does not exceed 100.



CAUTION

For safety, users should ensure that the electrical ground of the power utility, the telephone lines and the metallic water pipes are connected together. Users should NOT attempt to make such connections themselves but should contact the appropriate electric inspection authority or electrician. This may be particularly important in rural areas.

Avis Aux Utilisateurs Du Réseau

Téléphonique Canadien

L'étiquette canadienne Industrie Canada identifie l'équipement certifié. Cette certification signifie que l'équipement satisfait certaines normes de protection, d'exploitation et de sécurité des réseaux de télécommunications. Le département ne garantit pas le fonctionnement de l'équipement à la satisfaction de l'utilisateur.

La série LifeBook™ 500 possèdent un modem interne conforme aux normes de certification d'Industrie Canada pour protéger les réseaux de télécommunications et satisfaire aux normes de sécurité. Avant de connecter cet équipement à une ligne téléphonique, l'utilisateur doit vérifier s'il est permis de connecter cet équipement aux installations de télécommunications locales. L'utilisateur est averti que même la conformité aux normes de certification ne peut dans certains cas empêcher la dégradation du service.

Les réparations de l'équipement de télécommunications doivent être effectuées par un service de maintenance agréé au Canada. Toute réparation ou modification, qui n'est pas expressément approuvée par Fujitsu PC Corp.,

ou toute défaillance de l'équipement peut entraîner la compagnie de télécommunications à exiger que l'utilisateur déconnecte l'équipement de la ligne téléphonique.

Le code d'arrangement de connexion de cet équipement est CA11A.

Le numéro de charge est 3.

Le numéro de charge assigné à chaque terminal téléphonique indique le pourcentage de la charge totale pouvant être connecté à une boucle ou à un circuit téléphonique, utilisé par ce périphérique afin de prévenir toute surcharge. La terminaison d'une boucle peut être constituée de n'importe quelle combinaison de périphériques de sorte que le total de numéros de charge de tous les périphériques n'excède pas 100.



AVERTISSEMENT

Pour assurer la sécurité, les utilisateurs doivent vérifier que la prise de terre du service d'électricité, les lignes téléphoniques et les conduites d'eau métalliques sont connectées ensemble. Les utilisateurs NE doivent PAS tenter d'établir ces connexions eux-mêmes, mais doivent contacter les services d'inspection d'installations électriques appropriés ou un électricien. Ceci peut être particulièrement important en régions rurales.

UL NOTICE (FOR AUTHORIZED REPAIR TECHNICIANS ONLY)

CAUTION: For continued protection against risk of fire, replace only with the same type and rating fuse.

CAUTION: Danger of explosion if CMOS battery is incorrectly replaced. Replace only with the same or equivalent type recommended by the manufacturer. Dispose of used batteries according to the manufacturer's instruction.

WARNING: CMOS and NiCAD batteries may explode if mistreated. Do not recharge, disassemble or dispose of in fire.

Table of Contents

PREFACE v

**SECTION ONE
SETTING UP YOUR
LIFEBOOK 700 SERIES**

Unpacking 2
 Overview of Features 3
 Component Identification 4
 Top and Front Components 6
 Left Side Panel Components 7
 Right Side Panel Components 7
 Rear Panel Components 8
 Bottom Components 10
 Power Sources 10
 Data Security 11
 Starting Your Notebook for the First Time . . 12
 User Registration 14
 Learning About Your Operating System
 and Application Software 15

**SECTION TWO
USING YOUR LIFEBOOK 700 SERIES**

Display Panel 18
 Adjusting the Keyboard Angle 18
 Status Indicator Panel 19
 Power On 23
 Power Off 24
 Restarting the System 25
 Fujitsu Welcome Center 26
 Batteries 26
 Integrated ErgoTrac Pointing Device 30
 Using the Keyboard 32
 Volume Control 34
 Floppy Disk Drive 34
 CD-ROM Drive 36
 Hard Drive 38
 Power Management 38
 Internal Modem 46
 Infrared Port 46
 Pre-Installed Software 47

**SECTION THREE
CONFIGURING YOUR
LIFEBOOK 700 SERIES**

Boot Sequence 52
 Identifying the Drives 52
 BIOS Setup Utility 53
 Navigating Through the Setup Utility 55
 Main Menu – Setting System Parameters . . 56
 Advanced Menu – Setting Device Controls . 65
 Security Menu – Setting Passwords 77
 Power Savings Menu – Setting Power
 Management Controls 81
 Boot Menu 88
 Exit Menu – Leaving the Setup Utility 90
 Setting Up Your Save-To-Disk
 File Allocation 93

Table of Contents

SECTION FOUR USER INSTALLABLE FEATURES

Multi-function Bay Devices	97
PC Cards	103
Parallel Port Devices	105
Serial Port Devices	105
USB Devices.	105
Microphone	105
Stereo Line In Devices	105
Headphones.	105
Telephone Lines.	106
Mouse or Keyboard.	106
External Monitor	106
Theft Prevention Lock	106
External Installation of the	
Floppy Disk Drive	107
Memory Upgrade Module	108
Landock	111
Port Replicator	112

SECTION FIVE TROUBLESHOOTING

Identifying the Problem	118
Specific Problems	119
Power On Self Test Messages	138
Emergency CD-ROM	
Tray Release	141
Modem Setup and Commands	141
Restoring Your Pre-installed Software	
from CD-ROM	141

SECTION SIX CARE AND MAINTENANCE

Care and Maintenance.	144
Caring for Your Notebook.	144
Increasing Battery Life	145
Caring for Your Batteries	145

APPENDIX A SPECIFICATIONS

Warranty	148
LifeBook™ 735Dx Specifications.	148
LifeBook 755Tx Specifications	151
LifeBook 765Tx Specifications	154
Approvals.	157
Popular Accessories	157

APPENDIX B GLOSSARY 159

INDEX 167

PREFACE

The LifeBook 700 Series from Fujitsu™ PC Corporation is a powerful notebook computer. It is powered by an Intel Pentium® microprocessor with MMX™ technology, has a built-in color display, a CD-ROM drive and brings the computing power of desktop personal computers (PCs) to a portable environment.

This manual explains how to operate your LifeBook 700 Series' hardware and built-in system software. The LifeBook 700 Series is compatible with the IBM® PC AT. It comes with Windows® 95 pre-installed.

A LifeBook 700 Series is a completely self-contained unit with a dual scan passive-matrix (DSTN) or an active-matrix (TFT) color LCD display. It has a powerful interface that enables it to support a variety of optional features. (Figure P-1.)

CONVENTIONS USED IN THE GUIDE

Screen examples in this manual are intended as examples only, and screen and file names may differ in actual use.

Messages displayed by the LifeBook 700 Series appear in *Courier* type.

Example: Shutdown the computer?

Keyboard keys are shown in boldface Helvetica type.

Example: **Fn**, **F1**, **Esc**, and **Ctrl**.

Pages with additional information about a specific topic are cross-referenced within the text.

Example: (See page xx.)



POINT

The point icon highlights information that will enhance your understanding of the subject material.



CAUTION

The caution icon highlights information that is important to your safety, to the safe operation of your computer, or to the integrity of your files. Please read all caution information carefully.

LifeBook 700 Series from Fujitsu

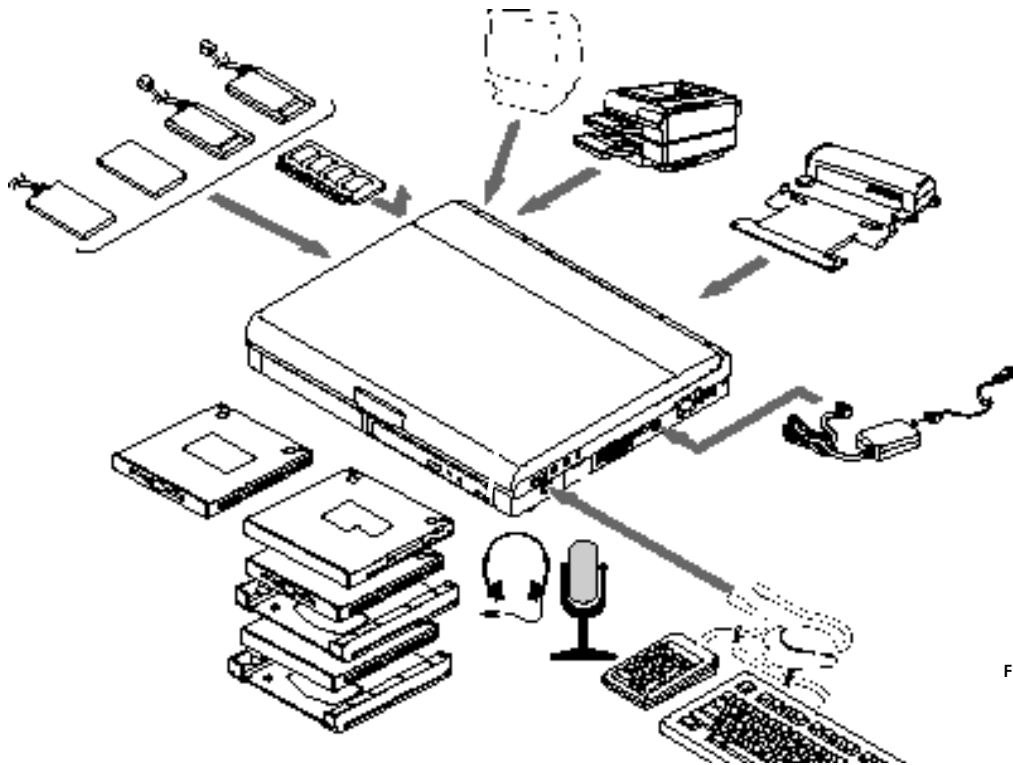


Figure P-1 LifeBook 700 Series with Both Fujitsu and Third Party Options

Setting Up Your LifeBook 700 Series

Unpacking	2
Overview of LifeBook 700 Series Features	3
Component Identification	4
Top and Front Components	6
Left Side Panel Components	7
Right Side Panel Components	7
Rear Panel Components	8
Bottom Components	10
Power Sources	10
Data Security	11
Starting Your Notebook for the First Time	12
User Registration	14
Learning About Your Operating System and Application Software.	15

Section One

SETTING UP YOUR LIFEBOOK 700 SERIES FROM FUJITSU

This section describes how to set up your LifeBook 700 Series from Fujitsu. We strongly recommend that you read it before using your notebook – even if you are already familiar with notebook computers.

UNPACKING

When you receive your notebook, unpack it carefully, and compare the parts you have received with the items listed below.

For a standard configuration you should have:

- LifeBook 700 Series from Fujitsu. (Figure 1-1.)
- AC adapter with AC power cord (located in the accessories box). (Figure 1-2.)
- Modular Lithium ion battery (already installed in Multi-function Bay 1 of your notebook).

- Modular 20-speed maximum CD-ROM drive (already installed in Multi-function Bay 2 of your notebook).
- Modular 3.5" floppy disk drive (located in the accessories box). (Figure 1-4.)
- Device adapter for Multi-function Bay 2 (located in the accessories box.) (Figure 1-3.)
- RJ-11 cable (located in the accessories box).
- Getting Started Guide.
- User's Guide.
- Microsoft Windows 95 Manual.
- Registration card and customer information pack.
- Recovery CD-ROM (located in the accessories box).
- Additional equipment and/or documentation depending on the option package you have purchased.

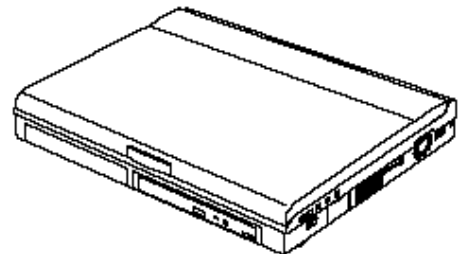


Figure 1-1 LifeBook 700 Series Notebook

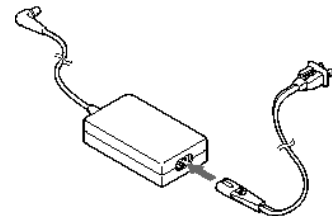


Figure 1-2 AC Adapter Unit

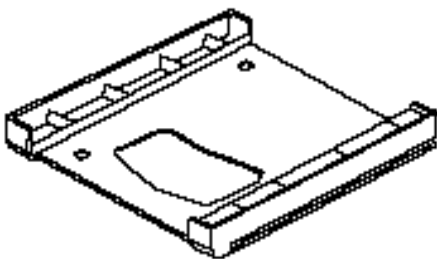
Setting Up Your LifeBook 700 Series

Figure 1-3 Device Adapter for Multi-function Bay 2

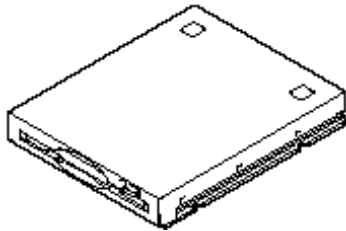


Figure 1-4 Floppy Disk Drive

Once you have checked and confirmed that your notebook system is complete, connect the AC adapter and follow the instructions on page 12-14 to accept the conditions for using the LifeBook 700 Series. When you have completed the Conditions of Use process please register your notebook. (See page 14.)

OVERVIEW OF LIFEBOOK 700 SERIES FEATURES

The LifeBook 700 Series is a compact, yet powerful notebook computer available with standard features including: (See Appendix A, pages 148-157, for detailed information on individual models.)

- 133MHz, 150MHz or 166MHz Intel Pentium processor with MMX technology.
- 16MB or 32MB SDRAM standard, expandable to 80MB or 96MB.
- 12.1" dual-scan (DSTN) or active-matrix (TFT) color display with 800 x 600 resolution.
- 2MB EDO video RAM.
- Built-in 1.6GB, 2GB or 3.2GB hard drive.

- Dual Multi-function bays which support the following:
 - 3.5" floppy disk drive (included with all models).
 - 20-speed maximum CD-ROM drive (included with all models) (for Bay 2 only).
 - Optional second 3.2GB hard drive (for Bay 2 only).
 - Lithium ion battery (one included with all models).
 - Optional second Lithium ion battery.
- Internal 56K fax/data/voice modem with built-in telephony and DSVD support.

**CAUTION**

Your internal modem is designed to allow faster downloads from K56flex compliant digital sources. Maximum achievable download transmission rates may not reach 56kbps and will vary with line conditions

- **Full audio and video features:**
 - 16-bit SoundBlaster-compatible sound chip.
 - 3D-Stereo for multiple speaker effect.
 - Zoomed Video support for full motion video acceleration.
 - Built-in stereo speakers.
 - Built-in mono microphone.
 - Stereo line in jack.
 - Stereo headphone jack.
 - Microphone jack.
- Two Type II/one Type III PC Card slot.
- Fast IrDA (4Mbps) compatible infrared port for wireless data transfer.
- Integrated ErgoTrac pointing device for superb comfort and cursor control.
- External monitor support with simultaneous display capabilities.
- “No re-learning”, full-size keyboard with three dedicated Windows 95 keys.
- Hot swap connection for an external keyboard or an external mouse.
- USB device support.
- Bridge battery for warm-swapping capabilities for batteries.
- Standard pre-installed software:
 - Microsoft Windows 95 operating system.
 - LapLink for file transfers via modem, cable or infrared port.
 - PC-Doctor for system diagnostics.
 - SoftPEG from CompCore, an MPEG-1 video player.
 - McAfee VirusScan for virus protection.
 - ESS AudioRack for 3D-Stereo, audio CD and other audio controls.
 - MegaPhone for telephone applications including fax, dialing, and speakerphone.

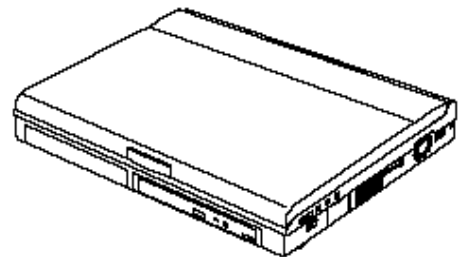


Figure 1-5 Top and Front Panel

- Some models may include additional software.

COMPONENT IDENTIFICATION

For detailed specifications on each model refer to Appendix A on pages 148-157.

Setting Up Your LifeBook 700 Series

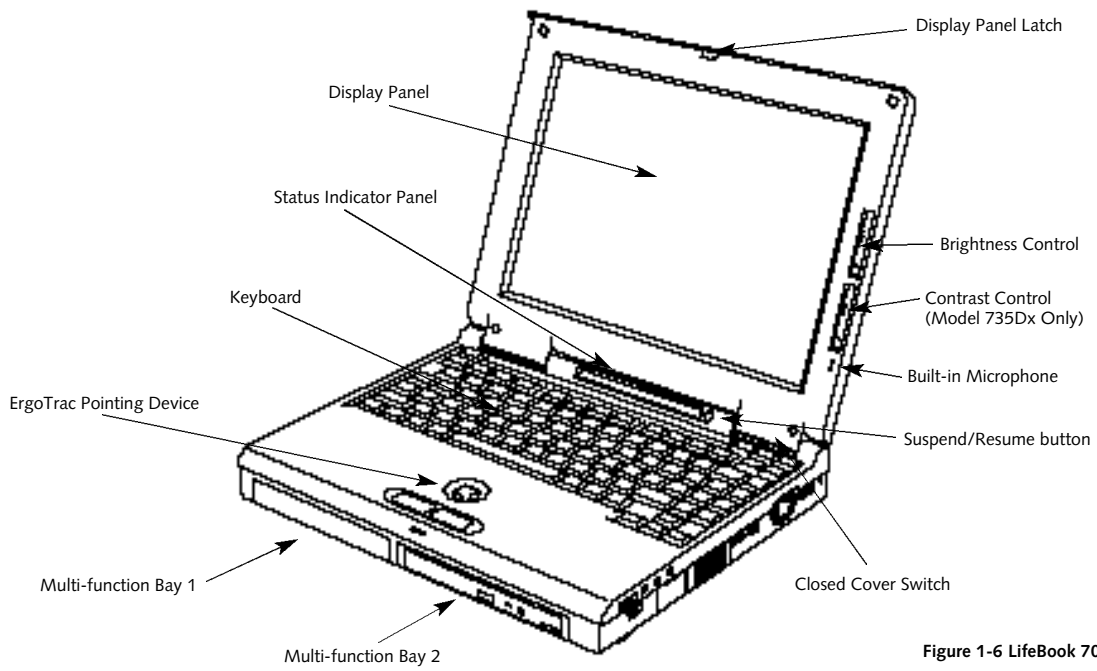


Figure 1-6 LifeBook 700 Series with Display Open

TOP AND FRONT COMPONENTS

Display Panel Latch

This latch locks and releases the display panel. When the display panel is released it pops up slightly to make it easier to open. (Figure 1-6.)

Display Panel

This is a color LCD panel with back lighting for the display of text and graphics. (Figure 1-6.)

Brightness Control

The brightness control adjusts the overall intensity of the display panel back lighting. (Figure 1-6.)

Contrast Control (Model 735Dx only)

The contrast control (located just below the brightness control) sets the ratio of the intensity of the light to dark areas of the display. (Figure 1-6.)

Built-in Microphone

The built-in microphone allows mono audio input to your notebook. (Figure 1-6.)

Status Indicator Panel

An LCD display of the status of the power state and source, Suspend mode, battery charge (battery in either Multi-function Bay), floppy disk drive activity, hard drive activity, CD-ROM drive activity, PC Card activity, CapsLock, NumLk and Scr Lk. (Figure 1-6.)

Suspend/Resume Button

The Suspend/Resume button allows you to suspend notebook activity without turning off the notebook power, and to return it to an active state. This feature saves power, and is particularly useful when the notebook is running only on battery power. (See pages 38-46 and 81-87 for more information on power management.) (Figure 1-6.)



CAUTION

Be sure you know which settings are active for your Suspend/Resume button before you use it because misuse can result in data loss. (See the *Power Savings Menu of the BIOS setup utility*, pages 81-87, for more information.)

Closed Cover Switch

The closed cover switch turns off the LCD back lighting when the display panel is closed, thus saving power. (Figure 1-6.)

Keyboard

A full-size keyboard with dedicated Windows 95 keys for input into the notebook. (Figure 1-6.)

ErgoTrac Pointing Device

The ErgoTrac pointing device is a joystick-like cursor control system with two click buttons. (Figure 1-6.)

Multi-function Bay One

This bay accommodates:

- Lithium ion battery.
- 3.5" floppy disk drive.

Multi-function Bay Two

This bay accommodates:

- 20-speed maximum CD-ROM drive.

Setting Up Your LifeBook 700 Series

- Lithium ion battery mounted in the device adapter for Multi-function Bay 2 (a second battery can be purchased separately for a dual battery configuration).
- Optional second 3.2GB hard drive (which must be purchased separately).
- 3.5" floppy disk drive mounted in the device adapter for Multi-function Bay 2.



CAUTION

Do not use your notebook with either of the Multi-function bays empty. It may damage your notebook.

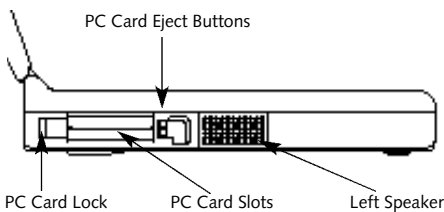


Figure 1-7 LifeBook 700 Series Left Side Panel

LEFT SIDE PANEL COMPONENTS

PC Card Slot

The PC Card Slot allows you to install two Type I or Type II PC Cards or one Type III PC Card. (See pages 103-105 for more information on PC Cards.) The button to the left of the card slot locks the card(s) in place, and the buttons to the right of the slot eject the card(s) from the slot. (Figure 1-7.)

Left Speaker

The built-in dual speakers output stereo sound from the notebook. (Figure 1-7 and Figure 1-8.)

RIGHT SIDE PANEL COMPONENTS

Theft Prevention Lock Slot

This is a slot that allows you to attach a physical lock down device. (Figure 1-8.)

USB Port

This port allows you to connect Universal Serial Bus devices, such as external game pads, pointing devices, keyboards and speakers. (Figure 1-8.)

DC Power Jack

The DC power jack allows you to plug in the AC adapter or the optional auto/airline adapter. (Figure 1-8.)

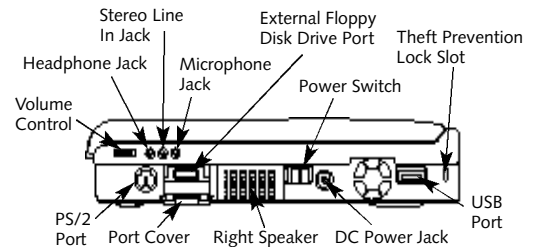


Figure 1-8 LifeBook 700 Series Right Side Panel

Power Switch

This switch is the main power switch for your notebook. (Figure 1-8.)

Right Speaker

The built-in dual speakers output stereo sound from the notebook. (Figure 1-7 and Figure 1-8.)

External Floppy Disk Drive Port

A port for attaching an optional external floppy disk drive. This allows you to connect an optional separate floppy disk drive when the Multi-function bays are being used for other purposes. (Figure 1-8.)

PS/2 Port

The port allows you to connect an external PS/2 keyboard, mouse, or numeric keypad. (Figure 1-8.)

Microphone Jack

The microphone jack allows you to connect an external mono microphone. (Figure 1-8.)

Stereo Line In Jack

The stereo line in jack allows you to connect an external audio source to your notebook, like an audio cassette player. This jack will not support an external microphone. (Figure 1-8.)

Headphone Jack

You can connect headphones or powered external speakers to the headphone jack. (Figure 1-8.)

Volume Control

The volume control is a knob which provides manual control of the sound level of all audio output from your notebook. (Figure 1-8.)



CAUTION

There are also software volume controls. The knob setting and the software settings will interact. Software volume off will override the knob setting and the software volume setting will control the maximum knob setting. (See *Volume Control* on page 34 for more information.)

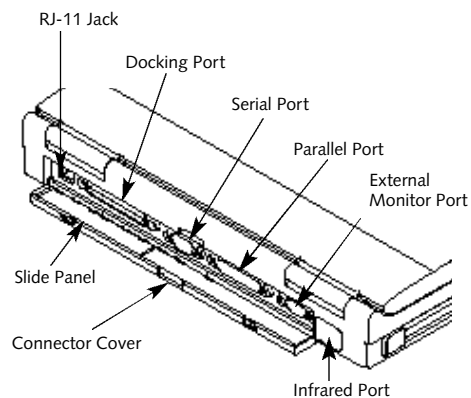


Figure 1-9 LifeBook 700 Series Rear Panel

REAR PANEL COMPONENTS

RJ-11 Jack

This is the jack for attaching a telephone line to the internal modem. This jack can be used with the connector cover closed and the sliding panel in the connector cover slightly opened for added convenience. (Figure 1-9.)

Setting Up Your LifeBook 700 Series**CAUTION**

The internal modem is not intended for use with Digital PBX systems. Do not connect the internal modem to a digital PBX as it may cause serious damage to the internal modem or your entire notebook. Consult your PBX manufacturer's documentation for details. Some hotels have Digital PBX systems. Be sure to find out BEFORE you connect your modem.

Docking Port

This port is for connection to an optional port replicator or docking station. The connector cover must be closed and the sliding panel fully opened to reveal the docking port and the RJ-11 jack when connecting a port replicator or a docking station. (Figure 1-9.)

**CAUTION**

The cover – which closes over the ports on the rear of the notebook – can be damaged if it is left open when the notebook is moved around.

Serial Port

The serial port allows you to connect serial RS-232C devices, such as serial printers or serial scanners. (This is also sometimes referred to as a COM port.) (Figure 1-9.)

Parallel Port

The parallel port allows you to connect parallel devices, such as a parallel printer to your notebook. (This is also sometimes referred to as a LPT port.) (Figure 1-9.)

External Monitor Port

This port allows you to connect an external VGA or SVGA CRT monitor. (Figure 1-9.)

Infrared Port

The fast IrDA (4Mbps) compatible port allows you to communicate with another IrDA compatible infrared device without a cable. (See pages 46-47 for more information.) (Figure 1-9.)

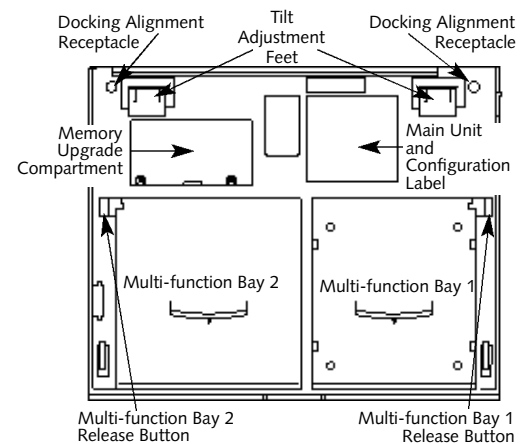


Figure 1-10 LifeBook 700 Series Bottom

BOTTOM COMPONENTS

Tilt Adjustment Feet

These are a pair of feet which flip down and hold the back of the keyboard approximately 6° higher than the front when resting on a flat surface. They are designed to make using your notebook keyboard more comfortable. (Figure 1-10.)

Main Unit and Configuration Label

This label shows the model number and other information about your notebook. In addition the configuration portion of the label has the serial number and manufacturer information that you will need to give your support representative so that he or she can help you. It identifies the exact version of various components of your notebook. (Figure 1-10.)

Memory Upgrade Compartment

This compartment houses the memory upgrade module which allows you to expand the system memory capacity of your notebook. (See pages 108-110 for more information on installing added memory capacity.) (Figure 1-10.)

Multi-function Bay 1 Release Button

This is the release to allow removal and installation of devices in the Multi-function Bay 1. (Figure 1-10.)

Multi-function Bay 1

This compartment is accessed from the front of your notebook. (See Figure 1-6 on page 5.)

Multi-function Bay 2 Release Button

This is the release to allow removal and installation of devices in the Multi-function Bay 2. (Figure 1-10.)

Multi-function Bay 2

This compartment is accessed from the front of your notebook. (See Figure 1-6 on page 5.)

POWER SOURCES

Your notebook has four possible power sources: the primary Lithium ion battery; an optional dual Lithium ion battery configuration; the AC adapter; or an optional auto/airline adapter.

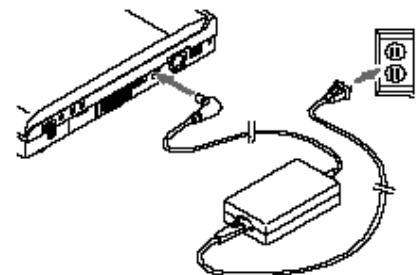


Figure 1-11 Connecting the AC Adapter

Connecting the Power Adapters

The AC adapter or an optional auto/airline adapter provides power for operating your notebook and charging the batteries. (Figure 1-11.)

To Connect the AC Adapter

1. Plug the DC Output cable of the AC adapter into the DC Power jack on the right side panel of your notebook.
2. Plug the AC adapter into an AC electrical outlet.

To Connect the Optional Auto/airline Adapter

1. **Plug the DC Output cable into the DC Power jack on the right side panel of your notebook.**
2. **Plug the auto/airline adapter plug into the cigarette lighter of a car or other vehicle with the ignition key in the On or the Accessories position or into the DC Power jack on an airplane seat.**

To Switch From AC Adapter Power
To Battery Power

1. **Be sure that you have at least one charged battery installed.**
2. **Remove the AC or auto/airline adapter.**



CAUTION

The primary Lithium ion battery is not charged when you purchase your notebook. Initially you will need to connect the AC adapter or the auto/airline adapter to use it. If you purchase a second Lithium ion battery it will not be charged when you get it. You will need to charge it prior to use. It can take up to three (3) hours to charge a single battery if your notebook is turned off or is in Suspend mode. If your notebook is in use it can take up to nine (9) hours or more to charge a single battery.

DATA SECURITY

Your LifeBook 700 Series has a built-in hardware control password security feature that allows you to protect the data stored in the notebook from unauthorized access. Your operating system and some applications have

software control password security features that allow you to protect all or portions of the data stored in the notebook from unauthorized access.

Hardware Data Security Features

When you are using your notebook built-in hardware control password to gain access to the notebook the actual password will not appear on the screen. This is a safety precaution. The hardware control security parameters are set from the BIOS setup utility. (See Security Menu on pages 77-80 for more information on setting and clearing passwords and enabling and disabling built-in security features.)

Software Data Security Features

The operating system and some applications have security features that are independent of the built-in hardware protection features that are controlled from the BIOS. See your software documentation for more information about these features.

CAUTION

Make sure you memorize your passwords, both hardware and software. If you forget, you may not be able to use the notebook, and you will have to contact your service provider and arrange to have them reset the hardware system password. See your software documentation for what to do if you forget your software security password(s).

CAUTION

Software security feature passwords may not be the same as the hardware security passwords. Be sure you know which features are controlled from software and which from hardware or you may lock yourself out of your own data or lock up your hardware and not be able to operate your notebook.

STARTING YOUR NOTEBOOK FOR THE FIRST TIME**Booting the System**

The first time that you turn on your notebook you will need to attach your AC adapter because the battery is not charged when you get your machine. We strongly recommend that you not attach any other external devices and do not put any CD or floppy disk in your drives until you have gone through the initial power on sequence.

When you turn on your notebook for the first time it will display a Fujitsu logo on the screen. If you do nothing the system will read the hard drive for the operating system software, flash the notebook configuration information on the screen, and then the Windows 95 Setup Wizard Screen will appear. (See *Power On* on pages 23-24 for additional help.) You will then be stepped through the condition of use process. You must complete this initial process before you will be able to use your notebook. (If you wish to access the BIOS setup utility before you go through the condition of use process you must

press the F2 key while the Fujitsu logo is still visible. If you press the Esc key while the Fujitsu logo is still present you will get a dialog box which will allow you to select which drive is to be used for finding the operating system.) If you turn off the power without using the on screen **Cancel button you will get an error message when you start your notebook again.**

Conditions of Use Process

The first time you start your notebook you must confirm your acceptance of the copyright limitations for your pre-installed software. After you complete the Condition of Use process these screens will not appear again. There are 6 screens to read carefully and respond to.

You cannot use your notebook until this Condition of Use process is completed. The bottom of each screen has a **<Back button, a **Next>** Button and a **Cancel** button which are activated by the integrated ErgoTrac cursor control and button click. The **<Back** button will return you to the previous screen. The **Next>** button activates any choices or**

Setting Up Your LifeBook 700 Series

information you have entered and takes you on to the next screen. The **Cancel** button allows you to stop the setup process.

If you stop the process your notebook will start up at the beginning of the Windows 95 Setup Wizard.

The screens you will be required to respond to are described with the required action.

User Information

Fill in your name and your company name as you want the software licensed. To step from the name blank to the company blank press the **Tab** key. When the information has been entered click on the **Next>** button. You will not be allowed to continue until you make an entry.

License Agreement

Read the agreement carefully. You can scroll through the text using the integrated ErgoTrac pointing device to activate the scroll bar or use the up arrow **↑** and down arrow **↓** keys to move up and down the text one line at a time, or use the **Page Up** and **Page Down** keys to

move the text one screen at a time. When you finish reading you must point and click to accept or reject the terms of the agreement and then click on the **Next>** button.



POINT

If you reject the terms of the license agreement you will be asked to review the license agreement for information on returning Windows 95 or to shut down your notebook.

Certificate of Authenticity

Look in the box that your notebook came in and you will find a Windows 95 Certificate of Authenticity shrink wrapped with the Windows 95 Users manual. On the certificate you will find a bar-code with a number above it. This is your product code and the number you should enter on the Certificate of Authenticity screen. When you have entered the number exactly as shown then click on the **Next>** button.

Start Wizard

The Start Wizard screen will appear if you have entered a valid product code. When you click on the **Finish** button the display will flash various screens as the system identifies what hardware is installed and runs a virus check.

Time Zone

When your notebook has completely identified all of the installed hardware it will display a dialog box for entering which time zone you wish to set the clock to.

Windows Messaging

Once you have selected a time zone you will see a screen announcing that Windows messaging is being set up.

Printer Setup

When the messaging setup is complete a dialog box will appear for selecting which printer is to be attached to your notebook. You do not have to select a printer at this time. If you do not wish to select a printer, click on the **Cancel** button. If you do wish to select a printer click on the **Next** button and answer the questions.

Welcome to Windows 95

Once you have completed the printer setup or chosen not to set up a printer at this time you will see the Welcome screen for Windows 95. You can choose: **Windows Tour**; **What's New**; **Online Registration**; or **Close**. You are now in the Windows 95 operating system and the Condition of Use process will not be repeated.



POINT

You will find a Recovery CD-ROM packet in your accessories box. Please store the packet in a safe place in case there is a loss of data and it becomes necessary to re-install your operating system and and/or application programs. (See *Restoring Your Pre-installed Software from the Recovery CD-ROM* on page 141.)

USER REGISTRATION

There are three ways to register your notebook.

1. **The registration card provided in the box with your LifeBook 700 Series that can be filled out and mailed.**
2. **A registration form behind one of the Fujitsu Welcome Center icons that can be filled out on your notebook and sent in a variety of ways, including printing and mailing, faxing or e-mailing.**
3. **Telephone registration by calling the Fujitsu PC service and support line at 1-800-8FUJITSU (1-800-838-5487).**



CAUTION

There are two Fujitsu Welcome Center icons on your notebook desktop, one for use if you have a model 735Dx and the other for use if you have a model 755Tx or a model 765Tx. Be sure to use the correct icon or your product registration may be invalid. Choose carefully as using the incorrect form will invalidate your registration and may prevent you from receiving technical support.

LEARNING ABOUT YOUR OPERATING SYSTEM AND APPLICATION SOFTWARE

Tutorials

All operating systems and most application software have tutorials built-in. We highly recommend that you step through your tutorial before you use an application even if you are familiar with the same application on a different machine, an earlier version of the application, or a similar product.

Manuals

In the accessories box you will find manuals for Windows 95 and other pre-installed software.

Software manuals of pre-installed software that are not in the accessories box are available online. See the help screens of your pre-installed software. We recommend that you review these manuals for general information on the use of these applications and to get a basic understanding of what is covered in the manual, and how it is organized, should questions arise as you use the applications.

Using Your LifeBook 700 Series from Fujitsu

Using Your LifeBook 700 Series from Fujitsu . . .	18
Display Panel	18
Adjusting the Keyboard Angle	19
Status Indicator Panel.	19
Power On	23
Power Off	24
Restarting the System	25
Fujitsu Welcome Center	26
Batteries	26
Integrated ErgoTrac Pointing Device	30
Using the Keyboard.	32
Volume Control.	34
Floppy Disk Drive.	34
CD-ROM Drive.	36
Hard Drive	38
Power Managment	38
Internal Modem	46
Infrared Port	46
Pre-installed Software	47

SECTION TWO

USING YOUR LIFEBOOK 700 SERIES FROM FUJITSU

This section describes the indicators, buttons, connections and operating modes of your LifeBook 700 Series and their use.

DISPLAY PANEL

Opening the Display Panel

Lifting the latch releases the top of the display panel from the front of the notebook body. When the display panel is released it pops up slightly to make it easier to open. Lift the display panel backward until the screen is at a comfortable viewing angle. (Figure 2-1.)

Adjusting the Display Panel

When you turn on your notebook, you may want to adjust the brightness level of the screen for best visibility. To do this, adjust the brightness control slider on the right side of the display panel. (Figure 2-2.) You may need to adjust the brightness periodically for different

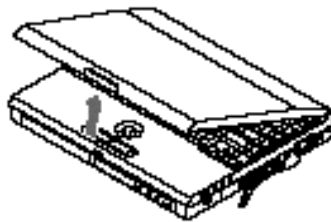


Figure 2-1 Opening the Display Panel

operating environments. (For model 735Dx only, you may also adjust contrast with a contrast control slider that is just below the brightness control.)



POINT

The higher the brightness level, the more power the notebook will consume and the faster your batteries will discharge. For maximum battery life, make sure that the brightness is set as low as possible.

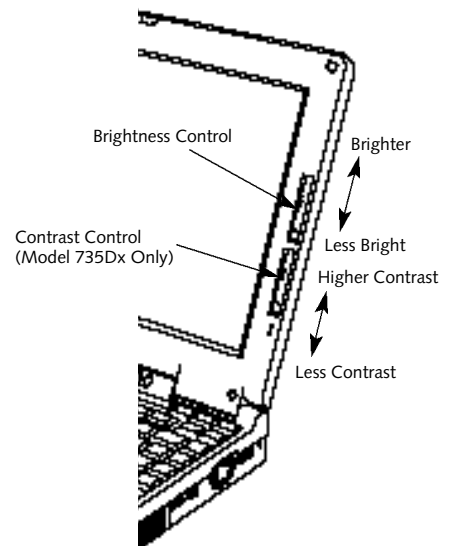


Figure 2-2 Display Adjustments

ADJUSTING THE KEYBOARD ANGLE

On the bottom of your notebook, near the back, are a pair of feet which flip down and hold the back of the keyboard about 6° higher than the front when resting on a flat surface. They are designed to make it more comfortable to use the keyboard with your notebook. The feet must be folded flat against the bottom of the notebook when opening or using the CD-ROM drive or it will not open or operate properly. (Figure 1-10 on page 9)

**CAUTION**

Do not operate your CD-ROM drive or attempt to open the tray unless your notebook is sitting on a flat surface and the adjustment feet are folded against the bottom of the notebook. Using a CD-ROM drive when it is not level may damage the drive or prevent proper operation.

**CAUTION**

When you are not using the adjustment feet be sure that they are folded flat against the bottom of the notebook. They could be broken off or injure someone if not used properly.

STATUS INDICATOR PANEL

The Status Indicator panel is located in the recess just above the keyboard. (Figure 2-3.) The appropriate indicators become visible as you use your notebook.

Power Indicator

The Power indicator tells you when the system is operational. It is on steady when there is power to your notebook, and blinks when the system is in Suspend mode. It goes off when the system has entered Save-to-Disk mode, has entered the Windows 95 pseudo-off state, or the power is turned off from the power switch.

**POINT**

When your notebook has been shut down from Windows 95, it is not the same as turned off from the power switch. It is in a pseudo-off state, with all applications closed, but can be turned on by pressing the Suspend/Resume button. It is drawing some current in the pseudo-off state.

**CAUTION**

Your notebook's power switch must be turned off to prevent all current draw.

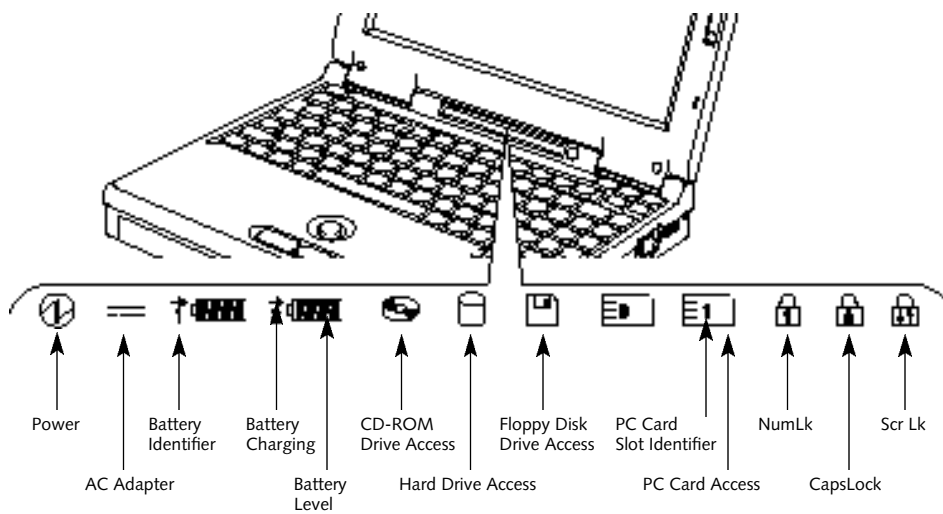


Figure 2-3 Status Indicator Panel

AC Adapter Indicator

The AC Adapter indicator tells you whether the system is operating on an AC or auto/airline adapter, or batteries alone. The indicator is On when either of the adapters is active and Off when power comes from the batteries alone. If a battery is charging, the Power Adapter indicator is active regardless of the setting of the power switch. The AC Adapter indicator is also active in the Windows 95 pseudo-off state, regardless of the battery status. If there is no battery charging, and the power switch is Off, then the AC Adapter indicator and the Battery indicators will all be Off.

Battery Indicators

The two sets of battery indicators show whether or not the primary Lithium ion battery and/or the optional second Lithium ion battery are installed, and indicate the condition of each. (Figure 2-3.) Battery 1 is the Lithium ion battery which is installed in Multi-function Bay 1 and Battery 2 is the Lithium ion battery which is installed in Multi-function Bay 2. The battery indicators are displayed only for a battery which is installed.

A small arrow icon (Battery Charging indicator) appears to the left of each of the Battery Level indicators and above the number (Battery identifier) if that battery is charging. The Battery Charging indicator flashes if the battery is too hot or too cold to charge. (Figure 2-3.) The Battery Charging indicators operate whether the power switch is Off or On.

The symbols inside the battery outline of the Battery Level indicator show the operating level available in that battery. (Figure 2-4.) If there is no battery charging and the power switch is Off then the AC Adapter indicator and the Battery indicators will all be off.

CAUTION

A shorted battery is damaged and must be replaced. (See Figure 2-4.)

CAUTION

Turning off the power with the power switch or using the Suspend/Resume button when any of the Access indicators are On may cause loss of data and/or system errors.

CAUTION

Batteries subjected to shocks, vibration temperatures or extreme temperatures can be permanently damaged.

CD-ROM Drive Access Indicator

The CD-ROM Access indicator tells you the CD-ROM drive is being accessed. The CD-ROM Access indicator will flash when the software tries to access a CD or CD-ROM even if no CD-ROM drive is installed.

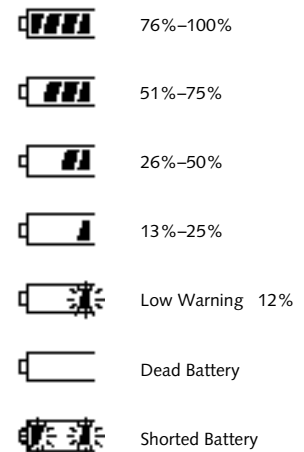


Figure 2-4 Battery Level Indicator

 **POINT**

The Windows 95 CD automatic insertion function will periodically check for a CD installed in the drive, causing the CD-ROM Access indicator to flash. The CD automatic insertion function allows your system to automatically start a CD as soon as it is inserted in the drive and the tray is closed. It will begin playing an audio CD or will start an application if the CD has an auto run file on it.

 **POINT**

If you do not wish to have the CD automatic insertion function on you can disable it.

To disable the CD automatic insertion function do as follows:

- 1. Save all data and close all applications.**
- 2. Click on the Start button.**
- 3. Point to Settings .**
- 4. Click on the Control Panel. The control panel window will be displayed.**
- 5. Double click on the System icon. The system properties dialogue box will be displayed.**
- 6. Click on the Device Manager tab. The device list will be displayed.**
- 7. Click on the + to the left of the CD-ROM icon. The CD-ROM drive manufacturer's name and model will be displayed.**
- 8. Click on the CD-ROM drive manufacturer's name and model.**
- 9. Click on Properties. The CD-ROM drive manufacturer's name and model properties dialogue box will be displayed.**
- 10. Click on the Settings tab.**

11. Click on the automatic insertion notification box to toggle it off.

12. Click on α .

13. Click on OK in the system properties dialogue box.

14. Restart your notebook according to the message displayed.

You can re-enable the function by repeating the process except in step 11 change the setting to on.

Hard Drive Access Indicator
The Hard Drive Access indicator tells you when either the internal hard drive or the optional second hard drive is being accessed.

 **POINT**

The Hard Drive Access indicator does not show which hard drive is being accessed. It works the same for either one.

Floppy Disk Drive Access Indicator

The Floppy Disk Drive Access indicator tells you a floppy disk drive is being accessed. The Floppy Disk Drive Access indicator will flash when your software tries to access a floppy disk even if no floppy disk drive is installed.

PC Card Access Indicators

The PC Card Access indicators tell you when an installed PC Card is being accessed. Card 0 is the bottom connector inside the slot and Card 1 is the upper connector inside the card slot. Type III cards are always Card 0 only. The PC Card Access indicator will flash if your software tries to access a PC Card even if none are installed.

**POINT**

Windows 95 displays of PC Card slot numbers may be different from the status indicator display slot numbers.

NumLk Indicator

The NumLk indicator tells you the internal keyboard is set in ten-key numeric keypad mode. (See page 33 for more information on the numeric keypad.) You can activate the NumLk mode by pressing the NumLk/Scr Lk key while holding down the Shift key. Deactivate the mode the same way that you activated it. This indicator is inactive if you are using an external keyboard.

CapsLock Indicator

The CapsLock indicator tells you when the keyboard is set for all capital letters. Activate the all capital letters setting by pressing the CapsLock key on the keyboard. Deactivate the setting the same way that you activated it. This indicator is inactive if you are using an external keyboard.

Scr Lk Indicator

The Scr Lk indicator tells you when scroll lock is active. You can activate or deactivate the scroll lock by pressing the NumLk/Scr Lk key. Deactivate the mode the same way that you activated it. This indicator is inactive if you are using an external keyboard.

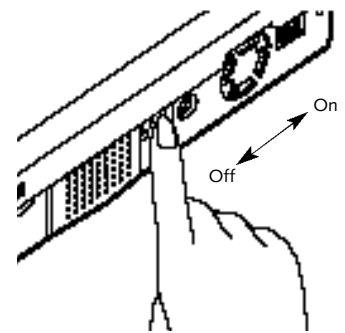


Figure 2-5 Power Switch

POWER ON

Facing the keyboard and display panel, move the power switch towards the rear of your notebook. This is the On position. (See Figure 2-5.) When you are done working you can leave your notebook in Suspend mode, (see pages 43 and 84), or you can turn it off. The power switch moved toward the front of your notebook is in the Off position. (See the section Power Off, pages 24-25, for the recommended shutoff procedures.)



CAUTION

After turning off your notebook, make sure that it has been Off at least 10 seconds before turning the power switch to On. If you do not you could cause a system error. When you turn on your notebook be sure you have a power source. This means that at least one battery is installed and charged, or that the AC adapter or the auto/airline adapter is connected and has power.



CAUTION

Do not carry your notebook around with the power on or subject it to shocks or vibration, as you risk damaging your notebook.



CAUTION

The main Lithium ion battery is not charged when you purchase your notebook. Initially you will need to connect the AC adapter to use it. If you purchase an optional second Lithium ion battery, it will not be charged when you get it, you will need to charge it prior to use.

When the power switch is turned on, your notebook carries out a Power On Self Test (POST) to check the internal parts and configuration. If a fault is found a beep will sound and/or an error message will be displayed. (See Troubleshooting on pages 138-140) Depending on the nature of the problem you may be able to continue by starting the operating system or by entering the setup utility and revising the settings.

After satisfactory completion of the Power On Self Test (POST) your notebook will load your operating system. (See Boot Menu on pages 88-89 to see which kind of disk will be the source.)



CAUTION

Never turn off your notebook during Power On Self Test (POST) or it will cause an error message to be displayed when you turn your notebook on the next time. (See the Troubleshooting information on pages 138-140.)

POWER OFF

Before turning off the power by putting the power switch in the Off position, check that the Hard Drive, CD-ROM, PC Card and the Floppy Disk Drive Access indicators are all Off. (See Figure 2-3, page 20.) If you turn off the power while accessing a disk or PC Card there is a risk of loss of data. The Off position is reached by facing the keyboard and display panel, and moving the switch toward the front of your notebook. To assure that your notebook shuts down without error, use the Windows 95 shut down procedure.

**CAUTION**

Never turn your notebook off while an application is running. Be sure to close all files, exit all applications and shut down your operating system prior to turning off the power with the power switch. If files are open when you turn the power off, you will lose any changes that have not been saved, and may cause disk errors.

Shutting down your notebook from Windows 95 lets your notebook shut down operations, and turn off the power in the proper sequence to prevent errors. The sequence is:

1. Go to the Start button menu.
2. Click on ShutDown .
3. Verify that Shut down the computer? is selected and click on Yes .

If you are going to store your notebook for a month or more, take the following precautions:

1. Remove any CD and/or floppy disk.
2. After shutting down with Windows 95 turn off your notebook using the power switch.
3. Close your notebook display panel.
4. Disconnect the AC adapter.
5. Remove the batteries and store them separately in a cool dry place.

**POINT**

When your notebook has been shut down from Windows 95, it is not the same as being turned off from the power switch. It is in a pseudo-off state, with all applications closed, but can and must be turned on by pressing the Suspend/Resume button. It is drawing some current in the pseudo-off state.

RESTARTING THE SYSTEM

When you wish to restart your system be sure that you follow the proper procedure. The procedure is as follows:

1. Go to the Start button menu.
2. Click on ShutDown .
3. Click on Restart the computer?
4. Verify that Restart the computer? is selected and click on Yes .

Windows 95 will shutdown and restart your notebook.

NOTE: You may also select Shut down the computer? and once the power is off for 10 seconds or more you can restart your notebook with the Suspend/Resume button. You may also select Shut down the computer? and once the power is off turn the power switch to Off for 10 seconds or more and then turn the power switch to On. These alternative methods are not recommended.

 **POINT**

In Windows 95 pressing the Ctrl+Alt+Del keys simultaneously triggers the ShutDown submenu of the Start menu.

 **CAUTION**

Turning off the power switch without exiting Windows 95 may cause an error when you start the next time. Turning the power to On when it has been Off for less than 10 seconds may also cause an error when you start the next time.

FUJITSU WELCOME CENTER

The Fujitsu Welcome Center is an icon on your Windows 95 desktop. Clicking on it gives you access to product registration forms and instructions, change of address information and forms, contact information including telephone numbers and e-mail addresses, and an accessory

catalog with the information for ordering accessories for your notebook. Double left-click on the icon and then on the appropriate button for the information selection you wish.

BATTERIES

The Lithium ion batteries are rechargeable with an operating time of up to three (3) hours depending on active power management features and user activity levels. Your notebook can be operated on the primary Lithium ion battery alone or in a dual battery configuration with an optional second Lithium ion battery. A built-in bridge battery allows a charged Lithium ion battery to be exchanged for a discharged one by "warm-swapping". To warm-swap, have a charged battery ready, put your notebook in Suspend mode, remove the low battery and quickly insert a charged battery.

The Lithium ion battery operating time may become shorter than the reference value if it is used under the following conditions:

- When used at temperatures that exceed a low of 5°C or a high of 35°C. High temperatures

not only reduce charging efficiency, but can also cause battery deterioration. (The Charging icon on the Status Indicator panel will flash when you try to charge a battery that is outside its operating temperature range.)

- The battery charging capacity is reduced as the battery ages. If your battery is running low quickly, you should replace it with a new one.
- When using a high current device such as a modem, a LAN card, the CD-ROM drive, or the hard drive frequently.

Using the AC adapter will conserve your battery when using a high current device such as a modem, a LAN card, the CD-ROM drive, or the hard drive frequently.

**CAUTION**

Actual battery life will vary based on screen brightness, applications, features, power management settings, battery condition, and other customer preferences. CD-ROM drive or hard drive usage may also have a significant impact on battery life.

**CAUTION**

Do not leave a faulty battery in your notebook. It might damage your AC adapter, optional auto/airline adapter, another battery, or your notebook itself. It may also prevent operation of your notebook by draining all available current into the bad battery.

**CAUTION**

Under federal, state or local law it may be illegal to dispose of batteries by putting them in the trash. Please take care of our environment and dispose of batteries properly. Check with your local government authority for details regarding recycling or disposing of old batteries. If you cannot find this information elsewhere, contact your support representative at 1-800-8FUJITSU (1-800-838-5487).

Bridge Battery

The bridge battery is a NiCd battery that is built-in your notebook and is constantly being recharged. A bridge battery allows a charged Lithium ion battery to be exchanged for a discharged one by “warm-swapping”.

To warm-swap have a charged battery ready, put your notebook in Suspend mode, remove the low battery and quickly insert a charged battery. The bridge battery capacity is not large, about 3 minutes, and can vary with the condition of your notebook.

**CAUTION**

Data may be lost and/or system errors introduced if the warm swap is not performed quickly or a power adapter installed.

**CAUTION**

The bridge battery can not support an operating notebook. The notebook must be in Suspend mode.

Shorted Batteries

If your Status Indicator panel shows a shorted battery, check the installation for that battery by removing and re-installing it. If it still shows that it is shorted, replace it with a new battery.



CAUTION

A shorted battery is damaged and must be replaced so that it does not damage anything else.

Recharging the Batteries

If you want to check the condition of either the primary Lithium ion battery or an optional second Lithium ion battery, check the Battery Level indicators located on the Status Indicator panel. These indicators change as the battery levels change. Battery 1 is a Lithium ion battery which is installed in Multi-function Bay 1 and Battery 2 is a Lithium ion battery which is installed in Multi-function Bay 2. (Figure 2-3 on page 20.) You can also check the PowerPanel toolbar.

The Lithium ion batteries are recharged internally using the AC adapter or auto/airline adapter. To recharge the batteries:

- Make sure the battery to be charged is installed in either Multi-function bay of your notebook and connect the AC or auto/airline adapter.
- Make sure that the Battery Charging indicator to the left of the Battery Level indicator of the battery to be charged is visible on the Status Indicator panel.
- Make sure the percentage charge is shown inside the Battery Level icon. (Figure 2-4 on page 21.)

When two Lithium ion batteries are installed, the charge/discharge rate of the primary and optional second Lithium ion batteries are the same, as they are connected in parallel and are both charging and/or discharging at the same time. Since the rates are the same, one may finish charging or discharging before the other if

they were not at the same charge level when they were installed and/or the AC or auto/airline adapter was connected.

There is no memory effect on the Lithium ion batteries, which means that you do not need to discharge them completely before recharging. A single fully discharged Lithium ion battery will charge in approximately three (3) hours when your notebook is Off or in Suspend mode. The charging time from fully discharged for two Lithium ion batteries together, is approximately 5 hours when your notebook is Off or in Suspend mode. Of course partially charged batteries will not take as long to charge. The charge times will be significantly longer if your notebook is in use while the batteries are charging (from approximately nine (9) hours for one battery to approximately 15 hours for two batteries with normal operating levels).



CAUTION

Using heavy current devices such as LAN cards or frequent CD-ROM accesses may prevent charging completely.

Low Battery State

When the battery is running low, your notebook beeps about every 15 seconds and the Battery Level indicator(s) flash. If you do not respond to the low battery alarm, the batteries will continue to discharge until they are too low to operate. When this happens there will be a multiple beep alarm, the Battery Level indicator will show dead battery, and your notebook will go into Suspend mode to try and protect your data as long as possible. Your power management settings do not affect what happens at the dead battery alarm level. Your notebook will go to Suspend mode. (Figure 2-3 on page 20.)



CAUTION

You may not be able to hear the audio alarms if the volume control is set too low or is turned off by either hardware or software but you will still be able to see the Battery Level indicator(s) flash.

When the low battery alarm occurs you need to save all your active data and put your notebook into Suspend mode until you can provide a new power source. You should provide this power as soon as possible. The new power source can be a charged battery or a power adapter, either AC or auto/airline.



CAUTION

When you are in Suspend mode there must always be at least one power source active. If you turn off the power with the power switch, or remove all power sources, battery, AC adapter or auto/airline adapter, while your notebook is in Suspend mode any data which has not been saved to the hard drive will be lost.

Once your notebook goes into Dead Battery Suspend mode you will be unable to resume operation until you provide a source of power either from an AC adapter, an optional auto/airline adapter, or a charged battery. Dead

Battery Suspend mode shows on the Status indicator just like the normal Suspend mode. Once you have provided power, you will need to press the Suspend/Resume button to resume operation. In the Suspend mode, your data can be maintained for sometime. If a power source is not provided promptly, the Power indicator will stop flashing and go out, and you will have lost the data that was not stored.

Once you provide power you can continue to use your notebook while an adapter is charging the battery, but the battery trickle charges under these conditions. If you want to charge the battery more quickly, put your notebook into Suspend mode, or turn off your notebook while the adapter is charging the battery. (See *Power Off* on pages 24-25 for shutdown procedures.)



CAUTION

There is no guarantee that data will not be lost once your notebook enters the Dead Battery Suspend mode.

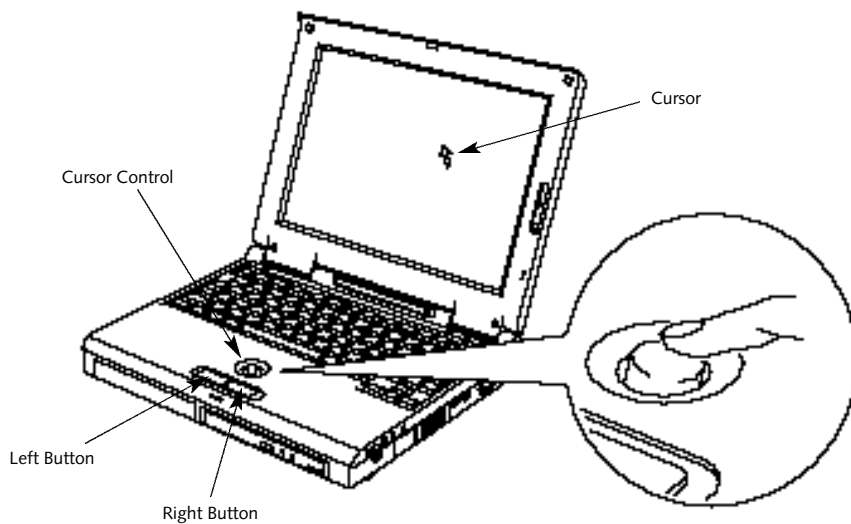


Figure 2-6 ErgoTrac Pointing Device

INTEGRATED ERGOTRAC POINTING DEVICE

The ErgoTrac pointing device is composed of a small joystick-like disc pointer control and two buttons located in front of the keyboard. The ErgoTrac pointing device has the function of a mouse, and moves the cursor around on the screen – up, down, left and right. A light pressure with the tip of your finger is all that is required to operate the ErgoTrac. The more pressure you use the faster the cursor will move. The second part of the ErgoTrac pointing device – the buttons – function as mouse buttons, and the functions they perform depend on the application you are running. Figure 2-6 shows the position of the ErgoTrac pointer and buttons.



POINT

An external mouse can be connected to the PS/2 port on the right side of the notebook, and used simultaneously with the ErgoTrac pointing device.

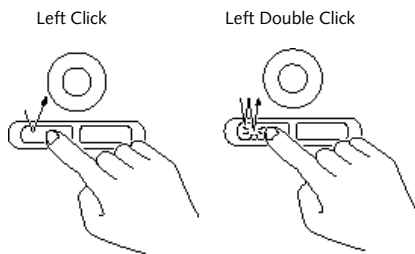


Figure 2-7 Clicking

Clicking

Clicking means pushing and releasing a button. To left-click move the screen cursor to the item you wish to select, press the left pointing device button once, and then immediately release it. To right-click, move the mouse cursor to the item you wish to select, press the right pointing device button once, and then immediately release it. (Figure 2-7.)

Double-Clicking

Double-clicking means following the preceding Clicking procedure, but pressing the pointing

device button twice in rapid succession. Double-clicking works with both the left and right buttons.



CAUTION

If the interval between clicks is too long, double-clicking will not be executed.



POINT

The interval between presses for double clicking, and other parameters of pointing and selecting, can be adjusted with the selections in the dialog box of the mouse icon in your Windows Control panel.

Dragging

Dragging means selecting an item with the pointing cursor, and while keeping the left pointing device button depressed, moving the cursor to the desired new location, then releasing the button. (Figure 2-8.)

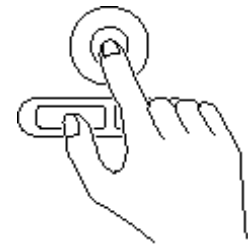


Figure 2-8 Dragging

ErgoTrac Pointing Device Control Adjustment

The Windows Control Panel provides customizing of your ErgoTrac pointing device from the mouse icon. There are four (4) aspects of the ErgoTrac pointing device operation which you can adjust.

- **Buttons** – This lets you set up the buttons for right or left handed operation and set the time interval for double clicking.

- **Pointers** – This lets you set up the size and shape of the cursor for different functions.
- **Motion** – This lets you set up the relation of the speed of motion of your finger to the motion of the cursor and to enable a trailing tail for the cursor arrow.
- **General** – This allows you to choose the type of mouse being used. It is already set for your integrated ErgoTrac. You may need to change it for an external mouse.

You may want to try practicing with different adjustments until you find a combination that is comfortable for you.

USING THE KEYBOARD

Your notebook has an integral 86-key keyboard. (Figure 2-9.) The keys perform all the standard functions of a 101-key keyboard and also include Windows 95 keys and other special function keys. This section describes only those items specific to your notebook. They are the numeric keypad, the cursor keys, the function keys, the function extension key (Fn) and the Windows 95 keys.

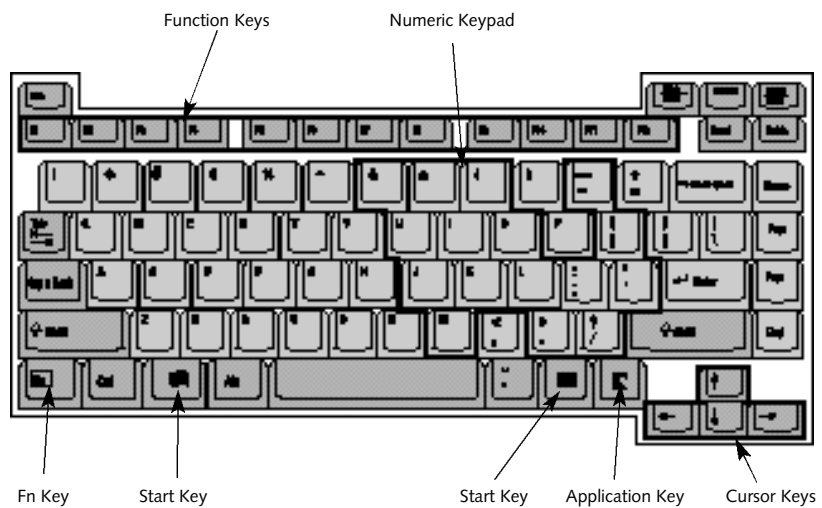


Figure 2-9 Keyboard

Numeric Keypad

Certain keys on the keyboard perform dual functions as both standard character keys and numeric keypad keys. Figure 2-9 highlights these keys. To switch into numeric keypad mode, press the NumLk/Scr Lk while holding down the Shift key. You can now enter numerals 0 through 9, perform addition (+), subtraction (-), multiplication (*), or division (/), and enter decimal points (.) using the keys designated as ten-key function keys. The keys in the numeric keypad are marked on the front edge of the key to indicate their secondary functions.

To return these keys to their normal character function, press the NumLk/Scr Lk while holding down the Shift key again.



POINT

When an external numeric keypad is connected to the notebook the NumLk mode enables the external keypad and disables the built-in keyboard numeric keypad.

Cursor Keys

The cursor keys are the four arrow keys on the keyboard which allow you to move the cursor up ↑, down ↓, left ← and right → as your application allows.



POINT

The integrated ErgoTrac pointing device and/or external mouse are also used for moving the cursor around the screen.

Function Keys

Your notebook has 12 function keys, F1 through F12. The functions assigned to these keys differ for each application. You should refer to your software documentation to find out how these keys are used. (See Figure 2-9.)

Fn Key

The Fn key provides extended functions for the notebook and is always used in conjunction with another key. (See Figure 2-9.)

Pressing F5 while holding down the Fn key allows you to toggle between video compensation and no compensation. (Video compensation controls spacing on the display. When it is enabled, displays with less than 800 x 600 pixel resolution will still cover the entire screen.)

Pressing F10 while holding down the Fn key allows you to change your selection of where to send your display video. Each time you press the combination of keys you will step to the next choice. The choices, in order, are: built-in display panel only, external monitor only, or both built-in display panel and external monitor.

Windows 95 Keys

Your notebook has three Windows 95 keys, two Start keys and an Application key. The Start key displays the Start menu. This is the same as the button on the toolbar which is typically at the bottom of your Windows 95 desktop. The Application key has the same function in Windows 95 as the right mouse button, it displays the Shortcut menu for whatever item is selected. See your Windows 95 documentation for additional information. (See Figure 2-9.)

VOLUME CONTROL

All system and application functions have multiple volume controls which interact with each other. There is the hardware volume control on the right side panel of your notebook. There is a volume control in the ESS AudioRack, your operating system Sound Control panel and any other application with sound.

Each setting source puts an upper limit on the volume which can be set by the other sources. For example if the hardware volume control is turned all the way down, your software volume control settings have no effect. By the same token, if the ESS AudioRack has the sound turned off, adjusting the hardware or other application software volume settings will not produce sound. One easy operating method is to use the hardware and ESS AudioRack volume controls to set an upper limit on sound level and then make fine adjustments with other application software.



CAUTION

The ESS AudioRack volume setting sets the maximum volume level of the hardware volume control knob.



CAUTION

If you use a speakerphone function, be sure that the microphone setting in the ESS AudioRack (recorder portion) is disabled.

FLOPPY DISK DRIVE

The modular floppy disk drive is a 3.5" drive which can read and write on 1.44MB and 720KB memory capacity floppy disks. Floppy disk format is controlled from your operating system. (See your software documentation for more information.) The modular floppy disk drive can be used in Multi-function Bay 1, Multi-function Bay 2 with the device adapter

for Multi-function Bay 2, or you can use the optional external floppy disk drive. The system will treat any floppy disk drive in exactly the same way regardless of where it is installed. (For floppy disk drive installation and removal instructions see Multi-function Bays on pages 97-100 and External Installation of a Floppy Disk Drive on page 107.) When your system boots it will always look first for a floppy disk drive in a Multi-function Bay 1, Multi-function Bay 2, and then look at the external floppy disk drive port.



CAUTION

To get your system to recognize a newly installed floppy disk drive you must restart your notebook.

Loading a Floppy Disk

To load, insert a floppy disk into the floppy disk drive, shutter side first and label up, until the Eject button, above the floppy disk drive opening, pops out. (Figure 2-10)

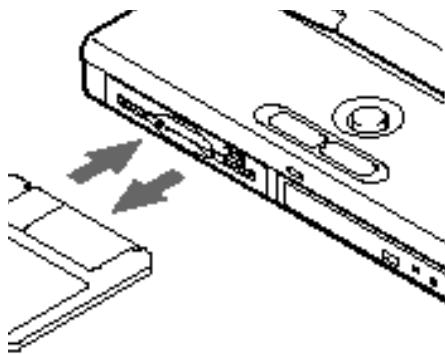
Using Your LifeBook 700 Series

Figure 2-10 Loading/Ejecting a Floppy Disk

**POINT**

When there is no floppy disk in the drive, the Eject button is flush with the front of your notebook.

Ejecting a Floppy Disk

To eject a disk, check that the Floppy Disk Drive Access indicator is Off, (see pages 20 and 23) and press the Eject button. (Figure 2-10.)

**CAUTION**

If you eject the disk while the Floppy Disk Drive Access indicator is On, there is a risk of damaging the data on the disk or the disk drive.

Preparing a Floppy Disk for Use

Before you can use a new floppy disk, you need to prepare it so your notebook knows where to store information. This preparation is called formatting or initializing a disk. You need to format new 3.5" floppy disks, unless you purchase preformatted disks. You will use your notebook's operating system software to format a floppy disk. Please refer to the operating system manual for step-by-step instructions.

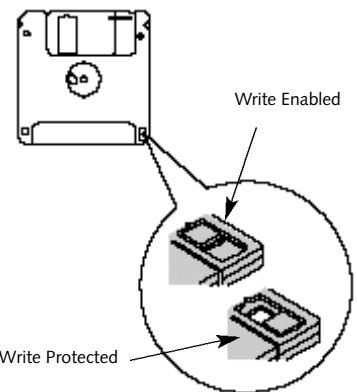


Figure 2-11 Floppy Disk Write Protect

To prevent data stored on a floppy disk from being erased, slide the write protect tab on the floppy disk to open up the small hole. This makes the disk write protected. When you want to write data to that disk, slide the write protect tab the other way to close the small hole.

CAUTION

Formatting a previously used floppy disk is an effective method of clearing a disk as long as you realize that ALL the information on the disk will be erased.

Care of Floppy Disk Drives and Disks

- **Avoid storing the floppy disk drive and disks in extremely hot and cold locations, or in locations subject to severe temperature changes.**
- **Keep the floppy disk drive and disks out of direct sunlight and away from heating equipment.**
- **Avoid storing the floppy disk drive in locations subject to shock and vibration.**
- **Avoid using the floppy disk drive and disks in damp and dusty locations.**
- **Never use the floppy disk drive with any liquid, metal, or other foreign matter inside the floppy disk drive or disk.**

- **Never store a floppy disk near a magnet or magnetic field.**
- **To clean, wipe the floppy disk drive clean with a dry soft cloth or with a soft cloth dampened with water or a solution of neutral detergent. Never use benzene, paint thinner, or other volatile material.**
- **Never disassemble or dismantle your floppy disk drive.**

CD-ROM DRIVE

The modular CD-ROM drive is a 20-speed maximum modular reader.

CAUTION

Do not operate your CD-ROM drive unless your notebook is sitting on a flat surface and the adjustment feet are folded against the bottom of the notebook. Using a CD when the drive is not level may damage the drive or prevent proper operation.



Figure 2-12 Loading the CD-ROM Tray

Loading a CD

- Make sure that the angle adjustment feet on the bottom of the notebook are folded against the bottom of the notebook.
- Make sure there is power to your notebook.
- Push, gently but firmly, and release the eject button on the front of the CD-ROM drive to open the CD-ROM holder tray, the tray will come out a short distance.
- Gently pull the tray out until a CD-ROM can be easily placed in the tray.
- If there was a protective sheet in the tray when it was shipped, make sure it has been removed.
- Place the CD into the tray, label side up, with the hole in the center of the CD snapped onto the raised circle in the center of the tray.
- Close the tray.
- After the CD is loaded, it will take a short time for your notebook to recognize it.



POINT

If you have disabled your CD automatic insertion function you will have to start the CD from your desktop, as your notebook will not automatically recognize that the CD has been loaded.

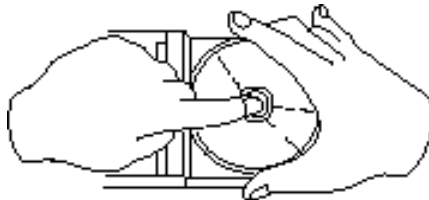


Figure 2-13 CD-ROM Handling

Care of CD-ROMs

CD-ROMs are precision devices and will function reliably if given reasonable care.

- Always store your CD-ROM in its case when it is not in use.

- When removing the CD-ROM from its case, press down on the holder's center while lifting out the CD-ROM by its edges.
- Always handle a CD-ROM by the edges and avoid touching the surface.
- Avoid storing any CD-ROM in extreme temperatures.
- Do not bend CD-ROMs or set heavy objects on them.
- Never write on the label surface with a ball point pen, pencil or similar device.
- If a CD-ROM is subjected to a sudden change in temperature, cold to warm condensation may form on the surface. Wipe the moisture off with a clean, soft, lint free cloth and let it dry at room temperature. DO NOT use a hair dryer or heater to dry a CD-ROM.
- If a CD-ROM is dirty, use only a CD-ROM cleaner or wipe it with a clean, soft, lint free cloth starting from the inner edge and wiping to the outer edge.

HARD DRIVE

The internal hard drive capacity is dependent on which model you are using. See Appendix A (pages 147-166) for model information. If you are using the optional second hard drive for the first time since you installed it, you can get your notebook to recognize it by opening the Windows 95 Control Panel and opening Add New Hardware which will step you through the process of having Windows look for your newly installed device.

Formatting the Hard Drive

The hard drive inside your notebook is formatted (initialized) at the factory. You do not need to format it under normal circumstances. If you purchase an optional second hard drive you will need to format it before you use it the first time. Check your operating system documentation for information on initializing a hard drive.



CAUTION

If you reformat the internal hard drive ALL data including the operating system, applications software and data will be erased. Unless data is copied to floppy disks or other data storage media it will be permanently lost. All software will be need to be re-installed and data files restored from your back-up disks. See the operating system manual for more information on backing-up your data files. The factory installed software, including the operating system, can be restored from the Recovery CD-ROM which came in the accessories box when you purchased your notebook. (See *Restoring Your Pre-installed Software from CD-ROM on page 141 for more information.*) Any application software which you have purchased and installed will have to be re-installed from the original source. When doing a recovery remember that you must allocate space

for the Save-to-Disk function if you have it enabled. (See *Setting Up Your Save-to-Disk File Allocation on pages 93-94 for more information.*)

POWER MANAGEMENT

Your LifeBook 700 Series has many features for conserving power. Some power savings features are automatic and have no user control, such as those for the internal modem, while others depend on the parameters you set to best suit your operating conditions. Other power saving features turn the display brightness down, limit the use of high power devices, activate an appropriate power savings profile, and put your notebook in Suspend mode when not actually performing an operation. As with all mobile, battery-powered computers, there is a trade-off between performance and power savings.

Internal power management for your notebook is controlled from settings made in the BIOS setup utility, the PowerPanel by Phoenix

Technologies, and the Windows 95 Control panel. If no settings have been made in the PowerPanel or Windows 95 Control panel then the BIOS settings will be used. The PowerPanel and Windows 95 Control panel have been pre-set at the factory and will be active unless you disable them. Complete descriptions of the BIOS setup utility parameters are found in Section Three of this guide. Power management parameters are covered under the Power Savings menu. (See pages 81-87.)

Some particular power parameters are only available for setup from one of these places, others can be changed in any one of them.

Using the Suspend/Resume Button
When your notebook is active, the Suspend/Resume button, (Figure 1-7 on page 7), can be used to manually put your notebook into Suspend mode, or into the Save-to-Disk mode. Push the Suspend/Resume button, when your notebook is active but no Access indicators are on, and hold it in until it is acknowledged by activation of the selected mode. Which mode is



Figure 2-14 Suspend/Resume Button

activated is determined by the settings of the BIOS setup utility Power Savings menu. The default is Suspend mode. (See page 84 for how to select Save-to-Disk mode.)

If your notebook is suspended, pushing the Suspend/Resume button will return your notebook to active operation at the point where it went into suspension. The Suspend/Resume button is located next to the Status Indicator panel above the keyboard of your notebook. (Figure 2-14) You can tell whether or not your system is in Suspend mode by looking at the

Power indicator. (See pages 19-20.) If it is visible and not flashing, your notebook is fully operational. If it is visible and flashing, your notebook is in Suspend mode. If it is not visible, the power is Off, the power is in the Windows 95 pseudo-off state, or your notebook is in Save-to-Disk mode. (See pages 44-45.) When you receive your LifeBook 700 Series it will be set to the default, which is Suspend mode.



CAUTION

Be sure you know which settings are active for the Suspend/Resume button before you use it; misuse can result in data loss. (See the Power Savings Menu of the BIOS setup utility, pages 81-87, for more information.)

 **POINT**

Disabling the Suspend/Resume button prevents it from being used to put your notebook in Suspend or Save-to-Disk mode. The resume function of the button cannot be disabled. (See the *Power Savings Menu of the BIOS setup utility*, pages 81-87, for more information.)

 **CAUTION**

The Suspend or Save-to-Disk mode should not be used with certain PC Cards. Check your PC Card documentation for more information.

 **POINT**

If your notebook is active when you enter the Suspend or Save-to-Disk mode, changes to open files are not lost. The files are left open and memory is kept active during Suspend mode or the memory is transferred to the internal hard drive during Save-to-Disk mode.

 **CAUTION**

If you are running your notebook on battery power, be aware that the battery continues to discharge while your notebook is in suspend mode, though not as fast as when fully operational. With a fully charged internal Lithium ion battery the suspend mode will maintain your status for 24 hours or more.

PowerPanel

The PowerPanel by Phoenix Technologies provides Windows 95 desktop access to a comprehensive combination of power management settings without entering the BIOS setup utility.

The PowerPanel icon looks like an atom with its cloud of electrons. This icon will open the PowerPanel menu. You can view the menu in icon format along the edge of your desktop by moving the cursor against the edge where you have chosen to keep your PowerPanel toolbar and letting it sit there until the toolbar appears. (The default position for the toolbar is the left side of the screen, but you can move it to whichever edge you like by dragging.)

The power management toolbar has ten power profile choices and six activation choices. When you switch to AC powered operation the PowerPanel toolbar will automatically change to indicate AC power operation and will show the AC Power profile as active.

The profiles are groups of system settings designed to fit power operation to specific user operating conditions. The activations are short-cut ways to turn on specific power management features of your notebook.

The profile choices are:

- Maximum Battery Life.
- Maximum Performance.
- Presentation.
- Green PC.
- Power Management Off.
- AC Power.
- Word Processing.
- Communication.
- Games.
- Custom Settings.

The activation choices are:

- System Suspend.
- System Save-to-Disk.
- System Standby.
- Hard Disk Standby.
- Modem Power Toggle.
- Video Standby.



POINT

The AC Power profile is activated automatically when a power adapter is being used, unless it is overridden by another selection made after the adapter became active. It can be reactivated by selecting it or it can be activated by selection, even when operating only on battery power.

PowerPanel Online Help

To access help with your power management settings, move your cursor to the PowerPanel toolbar and right click. (See *Clicking on page 31.*) From the menu that appears select PowerPanel Help Topics.

PowerPanel Customizing

To modify your PowerPanel toolbar or create a custom toolbar, move your cursor to the PowerPanel toolbar and right click. From the menu that appears select Customize. Within the Customize dialog box you can choose to have the toolbar display at all times or to use your custom toolbar. You can also select from the same menu to Hide the toolbar. If you hide the toolbar you will have to double click on the edge where the toolbar was located to display it.

If you select Exit from the PowerPanel menu you will turn off the PowerPanel completely. To turn it back on go to the Program folder of the Start menu, select PowerPanel and click on it.

Maximum Battery Life Profile

The Maximum Battery Life profile is a factory installed combination of timeouts and other power savings parameters chosen as the settings that will produce the longest possible battery life.

Maximum Performance Profile

The Maximum Performance profile is a factory installed combination of timeouts and other power savings parameters chosen as the settings that will produce superior performance with reasonable battery life.

Presentation Profile

The Presentation profile is the same combination of timeouts and other power savings parameters as the Maximum Battery Life profile except that the display is never turned off. (This profile was designed to enhance the use of your notebook for slide show style presentations.)

Green PC Profile

The Green PC profile has the Video timeout and the Hard Drive timeout enabled but no standby or suspension modes enabled.

AC Power Profile

The AC power profile has all timeouts disabled and no other power management features enabled. This profile is activated automatically by plugging in a power adapter.

Custom Settings Profile

The Custom Settings profile has those power saving parameters that you set by right clicking on the Custom Settings icon and selecting Run from the menu which appears. You will then get a dialog box for setting the parameters.

Power Management Off

Turns off power management control from Windows 95 and PowerPanel. They are turned on from the Start menu, Control panel for the Windows 95 management and the Program folder for the PowerPanel management.

Word Processing Profile

The Word Processing profile is a factory installed combination of timeouts and other power savings parameters chosen as the settings that will produce superior performance with reasonable battery life when using your notebook for doing word processing.

Communication Profile

The Communication profile is a factory installed combination of timeouts and other power savings parameters chosen as the settings that will produce superior performance with reasonable battery life when using your notebook with the modem active during Internet, fax or speakerphone activities.

Games Profile

The Games profile is a factory installed combination of timeouts and other power savings parameters chosen as the settings that will produce superior performance with reasonable battery life when playing games on your notebook.

System Suspend Activation

Clicking on the Suspend button or selecting System Suspend on the PowerPanel menu will put your notebook in Suspend mode. Pressing the Suspend/Resume button turns the power back on and lets you begin where you left off. (See Figure 2-14 on page 39, and Suspend Mode on pages 43-44.)

System Save-to-Disk Activation

Clicking on the **Save-to-Disk** button or selecting **System Save to Disk** on the PowerPanel menu will put your notebook in **Save-to-Disk** mode. Your notebook will be left in the Windows 95 pseudo-off state. If the power switch is not turned off your notebook can be restarted by pressing the **Suspend/Resume** button which will cause the system memory to be reloaded from the hard drive and let you begin where you left off. (See *Figure 2-14* on page 39, and *Save-to-Disk Mode* on pages 44-45.)

System Standby Activation

Clicking on the **System Standby** button or selecting **System Standby** on the PowerPanel menu will put your notebook in **Standby** mode. You can return your notebook to normal operation by performing any activity such as pressing a key or touching the ErgoTrac joystick.

Hard Disk Standby Activation

Clicking on the **Hard Disk Standby** button or selecting **Hard Disk Standby** on the PowerPanel menu will turn off your internal hard drive. You

can return your notebook to normal operation by performing any hard drive operation.

Modem Power Toggle

Clicking on the **Modem Power Toggle** button or selecting **Modem Power Toggle** on the PowerPanel menu will turn the power to your modem on or off. To turn it back on or off select **Modem Power Toggle** again.

Video Standby Activation

Clicking on the **Video Standby** button or selecting **Video Standby** on the PowerPanel menu turns off the power to the display. You can return your notebook to normal operation by performing any activity such as pressing a key or touching the ErgoTrac.

Suspend Mode

The **Suspend** mode saves the contents of your notebook's system memory during periods of inactivity by maintaining power to critical parts while turning off the CPU, the display, the hard drive and all of the other internal components except those necessary to maintain system memory, recognize the **Suspend/Resume** but-

ton and restart. Your notebook can be put in **Suspend** mode by:

- Pressing the **Suspend/Resume** button until acknowledged.
- Selecting **Suspend** from the Windows 95 Start Menu.
- Selecting **System Suspend** from the PowerPanel toolbar or menu.
- Timing out from lack of activity.
- Battery level reaching the **Dead Battery Warning** condition.

Your notebook's system memory typically stores the file(s) on which you are working, the open application(s) and any other data required to support the operation(s) in progress. When you resume operation from **Suspend** mode, it returns to the point in the operation where it left off. You must use the **Suspend/Resume** button to resume operation, and there must be an adequate power source available, or your notebook will not resume.



CAUTION

Loss of all power sources, including batteries, while in the Suspend mode will cause lost data and inability to return to operation with the Suspend/Resume button.

Save-to-Disk Mode

The Save-to-Disk function saves the contents of your notebook's system memory to the hard drive whenever you:

- Press the Suspend/Resume button until acknowledged with Save-to-Disk mode enabled from the Power Savings menu of the BIOS setup utility.
- Select Suspend from the Windows 95 Start menu with Save-to-Disk mode enabled by the BIOS setup utility.
- Select Save-to-Disk activation from the PowerPanel toolbar or menu.

- Time out from lack of activity with Save-To-Disk mode enabled from the Power Savings menu of the BIOS setup utility.

Your notebook's system memory typically stores the file(s) on which you are working, the open application(s) and any other data required to support the operation(s) in progress. When the Save-to-Disk function is activated your notebook saves the contents of the system memory to a file on the internal hard drive, and then automatically shuts off power to your notebook. This is the same pseudo-off state as the Windows 95 power off. When you resume operation by pressing the Suspend/Resume button, you return to the point in the operation where you left off, before going into Save-to-Disk mode.



POINT

If power is lost during Save-to-Disk mode the data will be retrieved automatically as soon as power is returned.



POINT

When PC Cards or external devices are in use, Save-to-Disk mode cannot return to the exact state prior to suspension, because all of the peripheral devices will be re-initialized when the system restarts.



POINT

The main advantage of using the Save-to-Disk function is that power is not required to maintain your data. This is particularly important if you will be leaving your notebook in a suspended state for a prolonged period of time. The drawback of using Save-to-Disk mode is that it lengthens the power down and power up sequences and resets peripheral devices.

**POINT**

Save-to-Disk mode requires allocating a significant amount of hard drive capacity for saving all system memory, which reduces your usable disk space. When you purchase your notebook it will have space allocated for the memory installed. If you upgrade the original system by adding a memory upgrade module without changing the size of your Save-to-Disk allocation you will get an error message when you try to activate Save-to-Disk mode and it will not work. Use the PHDISK Utility to increase the size of the Save-to-Disk file, SAVE2DSK.BIN. (Refer to *Setting Up Your Save-to-Disk File Allocation* on pages 93-94 for more information.) If you need help contact your support representative for recommendations.

Idle Mode

Idle mode is one of the power management parameters. When Idle mode is enabled the CPU is put into low-speed operation when there is no activity (keystroke, pointer action, sound generation, video display change, modem transmission or reception, etc.) on your notebook for 16 seconds. Any activity will cause the normal operation to restart automatically. This feature is independent of the Suspend/Resume button. This parameter is enabled and disabled in the BIOS setup utility. (See page 83.)

Standby Mode

Standby mode is one of the power management parameters. When Standby mode is activated, your notebook puts the CPU in low-speed operation, shuts off the display and turns off the hard drive when there is no activity (keystroke, pointer action, sound generation, video display change, modem transmission or reception, etc.) on your notebook for the user selected time-out period. (See page 83.) Any activity will cause your notebook to return to normal

operation automatically. This feature is independent of the Suspend/Resume button. This parameter is enabled and disabled in the BIOS setup utility.

Video Timeout

The Video Timeout is one of the power management parameters which saves power by turning off the display if there is no keyboard or pointer activity for the user selected timeout period. Any keyboard or pointer activity will cause the display to restart automatically. This feature is independent of the Suspend/Resume button. This parameter is enabled and disabled in the BIOS setup utility. (See page 82.)

Hard Disk Timeout

The Hard Disk Timeout is one of the power management parameters which saves power by turning off the hard drive if there is no hard drive access for the timeout period which has been set in the BIOS setup utility. (See page 82.) Any attempt to access the hard drive will cause the hard drive to restart automatically. This feature is independent of the Suspend/

Resume button. This parameter is enabled and disabled in the BIOS setup utility.

Windows 95 Control Panel

The Power icon in the Windows 95 Control Panel allows you to enable or disable all the power management settings which can be made from the desktop. Selecting "Allow Windows to manage power use on this computer" allows the operating system to enable Phoenix Technologies PowerPanel and Windows 95 Control panel settings. When Windows 95 power management is disabled the BIOS setup utility settings will control your power saving parameters. (See pages 81-87 for the BIOS setup utility Power Savings menu.)

The Windows 95 Control Panel Power Management dialog box lets you set different hard drive timeouts for battery and AC power operation and to set PC Card modem power parameters.



POINT

You must restart your notebook for Windows 95 Control panel setting changes to take affect.

INTERNAL MODEM

Your internal modem is a fax/data/voice modem controlled by Windows 95, LapLink, MegaPhone or other software. The voice functions of the modem include speakerphone, caller ID and answering machine capabilities. The answering machine capabilities require the use of third party software not included with your notebook. The other features are accessible via Windows 95, LapLink or MegaPhone. (See page 3 for caution on modem.)

INFRARED PORT

Infrared IrDA-compatible communication is a function that allows for wireless data transfer between your notebook and other IrDA-compatible devices. Examples of IrDA-compatible

devices are another computer or a printer. When carrying out this kind of communication, both devices must be set so their infrared ports are directly facing each other without obstructions. A distance of 6" to 36" between the device ports is ideal. Dirt or scratches on the lens of your notebook or the other device will degrade performance. This is especially true for Fast IrDA applications such as a transfer to an Ethernet.

Before you can use the Infrared Port, you must set it up in the Advanced Menu, Integrated Peripherals submenu, in the BIOS setup utility (page 68). Since your notebook supports both IrDA 1.0 (115 Kbps) and IrDA 1.1 (4 Mbps) transfers you must select the standard which is compatible with the other device in the transfer. (See the BIOS Setup Utility on page 67 for more information.) LapLink software can be used for Infrared file transfers. See your online help for more information.

**CAUTION**

Do not move either device during communication as it may interrupt data transmission.

**CAUTION**

Be careful not to scratch the infrared port lens. Scratches, dirt or other surface marks can effect operation.

The following conditions may interfere with infrared communications:

- When the infrared communication ports are not directly facing each other, or some obstacle is between them.
- When the infrared communication ports are too far apart.

- When a television or radio remote control unit, or a wireless headphone is being used nearby.
- When a strong light such as direct sunlight, fluorescent light, or incandescent light shines on the port.

PRE-INSTALLED SOFTWARE

Your LifeBook 700 Series comes with pre-installed software for playing audio and video files of various formats. In addition there is file transfer software, telephony software and virus protection software. Some models come with additional application software.

All of the pre-installed software can be accessed from the Program folder of the Windows 95 Start menu. If you aren't sure what software is pre-installed check the Program folder. If you need assistance with an individual application use their online help.

SoftPEG MPEG File Player

The MPEG file player displays a screen to find the file which you wish to play. You can have the list select from limited to particular types of files or display all files. Opening the desired file will play it. Online help screens are available for more information.

SoftPEG CD Player

This control resembles a CD player front panel and is operated in the same way. When you point to a button, a small explanation of the use of the button will appear. When you left-click on the button it will activate. Online help screens are available for more information.

**POINT**

You can modify the set up of certain audio parameters in the BIOS setup utility, Advanced Menu – Audio Features Submenu. (See page 74.)

ESS AudioRack

The control of the AudioRack player software (AudioRack32) resembles the front panels of a rack of stereo equipment and is operated in much the same way. There is also AudioRack recorder software (AudioRecorder). Online help screens are accessible from the AudioDrive panel of AudioRack32, click on the Help button for more information. In the AudioRecorder dialog box, click on Help in the top taskbar.

In AudioRack32 the AudioDrive panel lets you turn on and off the available functions. When you left-click on a button it will activate. When a function is active, its button on the AudioDrive shows a green dot and its control panel is in the equipment rack. When it is off the dot on the button is black and the control panel is not in the rack. You activate a slider or knob on a control panel by dragging it. The functions available are DAT (Digital Audio Tape player), 3D (3D-Stereo sound control), MIDI, Mixer and CD (Audio CD player).



POINT

For maximum frequency response and bandwidth, leave the graphic equalizer levels at the mid-point (zero level). To customize the frequency response to your personal taste, adjust accordingly.



CAUTION

The ESS AudioRack volume settings set the maximum volume level of the hardware volume control knob for that function.



CAUTION

If you use a speakerphone function, be sure that the microphone setting in the ESS AudioRack is disabled.

LapLink

The LapLink, by Traveling Software, file transfer software provides direct file transfers to other computers. Data transfers can be via internal modem, a PC Card modem, the infrared port, a serial cable, or a parallel cable (cables are not included). See the LapLink online help screens for operating instructions.

MegaPhone

MegaPhone, by Cypress Research Corporation, is telephony software which provides access to the voice and fax features of your notebook's internal modem. It features dialing, speakerphone, and fax functions. See your MegaPhone online help screens for guidance in operating the MegaPhone software.

**POINT**

For optimum speakerphone performance:

- Speak clearly.
- Limit background noise.
- Speak facing the keyboard from about one (1) foot away.

McAfee VirusScan

Running your McAfee VirusScan program after loading data or programs from a floppy disk, CD-ROM, modem data transfer, or infrared data transfer is a precaution that will protect the data on your hard drive from contamination or destruction. See your VirusScan online help screens for information on how and when to run this program.

Configuring Your LifeBook 700 Series

Boot Sequence	52
Identifying the Drives.	52
BIOS Setup Utility	53
Navigating Through the Setup Utility	55
Main Menu – Setting Standard System Parameters	56
Advanced Menu – Setting Device Feature Controls	65
Security Menu – Setting the Security Features	77
Power Savings Menu – Setting Power Management Feature Controls	81
Boot Menu – Selecting the Operating System Source.	88
Exit Menu – Leaving the Setup Utility	90
Setting Up Your Save-To-Disk File Allocation	93

SECTION THREE

CONFIGURING YOUR LIFEBOOK 700 SERIES FROM FUJITSU

This section explains the BIOS setup utility. The BIOS setup utility is required to set the date, time, power management modes, data security passwords and other operating parameters of your notebook.

BOOT SEQUENCE

Each time you power up or restart your LifeBook 700 Series, it goes through a quiet boot sequence that displays a Fujitsu logo until your operating system is loaded. During quiet boot, your notebook is performing a standard boot sequence including a Power On Self Test (POST). To access the ability to change the drive that will be used for finding the operating system, press the Esc key anytime while the Fujitsu logo is displayed. To enter the BIOS setup utility press the F2 key anytime while the Fujitsu logo is displayed. When the boot sequence is completed without a failure and without a request for the setup utility, the

system displays the Windows 95 opening screen. The boot sequence is executed when:

- You turn on power to the system using the power switch on the right side panel of your notebook. (Figure 2-5 on page 23.)
- You restart your computer from the Windows 95 Shutdown dialog box of the Start Menu.
- The software initiates a system restart. Example: When you install a new application.
- You reset the system by pressing the three keys Ctrl+Alt+Del at the same time and then restart your computer from the Windows 95 Shutdown dialog box.



POINT

The BIOS setup utility is entered by pressing the **F2** key during the boot process while the Fujitsu logo is on the screen.



POINT

When error messages occur see Section Five, pages 138-140, for help in understanding the meaning and required actions to be taken.

IDENTIFYING THE DRIVES

Your notebook uses drive letters (Example A:, B:, C:, D:, E:) to identify internal and external devices such as hard drives, floppy disk drives, CD-ROM drives and PC Cards. The most commonly assigned drive designators are listed below. If you add other devices, the drive designators may be different. See your operating system manual for setting drive designations.

Drive Designators

A: Floppy disk drive.

Installable in either of the multi-function bays of your notebook, or use the external floppy disk drive.

B: Not used with your notebook.

C: Hard drive.

Installed inside your notebook.

D:CD-ROM drive or optional second hard drive. Installable in Multi-function Bay 2 of your notebook.

**CAUTION**

A bootable CD-ROM may have either a floppy disk format or a hard drive format. When using a bootable CD-ROM, drive designations will automatically change according to which format is used. (See page 63 for more information.)

BIOS SETUP UTILITY

The BIOS setup utility is a program that sets the operating environment for your notebook. It is referred to in this publication as the setup utility. There is no need to set or change the environment to operate as it is set at the factory for normal operating conditions.

The setup utility configures:

- Standard system parameters, such as date and time.
- Device control feature parameters, such as I/O addresses and boot devices.
- Power Management parameters that help to conserve your notebook's batteries.
- System Data Security feature parameters, such as passwords.

You will only have to change the utility settings if you want to:

- Change the date or time. (You can also do this without entering the setup utility, through your operating system. See your operating system manual.)
- Change the primary boot device.
- Change the power management parameter settings. (For a more convenient process, see the PowerPanel on pages 40-43.)

- Change a port address or other parameter.
- Change an audio parameter setting.
- Change the selection of whether to use the built-in display, an external monitor or both. (For a more convenient process, see the Fn key on page 33.)
- Change the system data security settings.

Routinely Entering the Setup Utility
You can enter the setup utility whenever you turn on or reset the system. To do this:

1. Allow the system to start booting.
2. As soon as the Fujitsu logo appears on the screen, press the F2 key.
3. The Main menu of the setup utility then appears with the current settings of the parameters displayed.
4. If you wish to go to one of the other setup menus, press the ← or the → key to find the menu you require.

 **POINT**

If your data security settings require it, you may be asked for a password before the Main menu will appear.

Entering the Setup Utility After a Configuration Change or System Failure
If there has been a change in the system configuration that does not agree with the parameter settings stored in your BIOS memory, or there is a failure in the system, the system beeps and/or displays an error message after the Power On Self Test (POST). If the failure is not too severe, it will give you the opportunity to modify the settings of the setup utility, as described in the following steps:

1. When you turn on or restart the computer there is a beep and/or the following message appears on the screen:

```
Error message - please run
SETUP program
Press <F1> key to continue, <F2>
to run SETUP
```

54

2. If an error message is displayed on the screen, and you want to continue with the boot process and start the operating system anyway, press the F1 key.

 **CAUTION**

If your notebook beeps a series of beeps that sounds like a code and the display is blank, please refer to the Troubleshooting Section. (See page 135.) The Troubleshooting Section includes a list of error messages and their meanings. (See pages 138-140.)

 **POINT**

If your data security settings require it, you may be asked for a password before the operating system will be opened.

3. If an error message is displayed on the screen, and you want to enter the setup utility, press the F2 key.
4. When the setup utility starts with a fault present, the system displays the following message:
Warning!
Error message
[Continue]
5. Press any key to enter the setup utility. The system will then display the Main Menu with current parameters values.

NAVIGATING THROUGH THE SETUP UTILITY

The BIOS setup utility consists of six menus; MAIN, ADVANCED, SECURITY, POWER SAVINGS, BOOT and EXIT. The remainder of Section Three explains each menu in turn including all submenus and setup items.

The following procedures allow you to navigate the setup utility menus:

1. To select a menu, use the cursor keys: ← , →.
2. To select a field within a menu or a sub-menu, use the cursor keys: ↑ , ↓.
3. To select the different values for each field, press the Spacebar or + to change to the next higher selection and F5 or - to go to the next lower selection.
4. To activate a submenu press the Enter key.
5. To return to a menu from a submenu, press the Esc key.
6. To go to the Exit menu from any other menu, press the Esc key.
7. Pressing the F9 key resets all items in the current menu to the default values.
8. Pressing the F10 key resets all items in the current menu to the value which was set when the setup utility parameters were last saved.
9. Pressing the F1 key gives you a general help screen.



POINT

Selecting a field causes a help message about that field to be displayed on the right-hand side of the screen



POINT

Pressing the **Enter** key with the highlight on a selection that is not a submenu or auto selection will cause a list of all options for that item to be displayed. Pressing the **Enter** key or **Esc** key will select the highlighted choice and remove the list.

MAIN MENU – SETTING STANDARD SYSTEM PARAMETERS

The Main Menu allows you to set or view the current system parameters. Follow the instructions for Navigating Through The Setup Utility to make any changes. (See page 55.)

Table 3-1 shows the names of the menu fields for the Main menu, all of the options for each field, the default settings and a description of the field's function and any special information needed to help understand the field's use.

POINT

System Time and System Date can also be set from your operating system without using the setup utility. Use the calendar and time icon on your Control panel for Windows 95 or type time or date from the MS-DOS prompt.

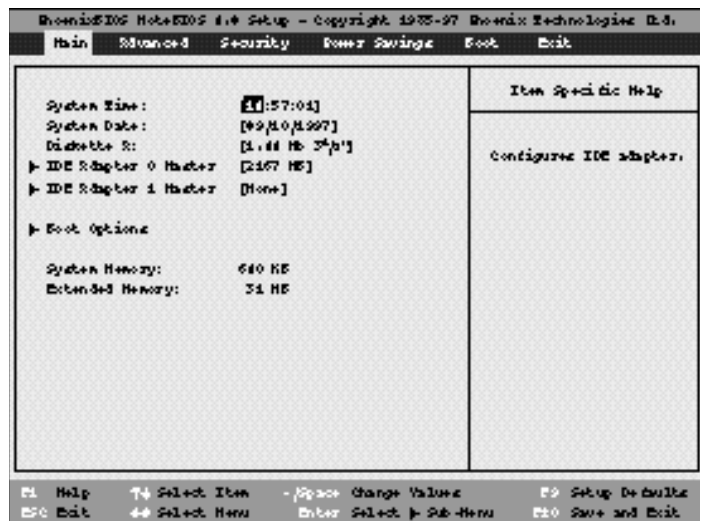


Figure 3-1 Main Menu

Configuring Your LifeBook 700 Series

Table 3-1 Fields, Options and Defaults for the Main Menu

Menu Field	Options	Default	Description
System Time	—	—	Sets and displays the current time. Time is in a 24 hour format of hours:minutes:seconds with 2 digits for each.(HH:MM:SS). Example: 16:45:57. You may change each segment of the time separately. Move between the segments with the Tab key and/or Shift + Tab keys.
System Date	—	—	Sets and displays the current date.Date is in a month/day/year numeric format with 2 digits each for month and day and 4 digits for year. (MM/DD/YYYY) for example: 03/20/1996. You may change each segment of the date separately. Move between the segments with the Tab key and/or Shift + Tab keys.
Diskette A	1.44Mb, 3.5"; Disabled	1.44Mb, 3.5"	Sets the format for floppy disk drive A if it is installed.
IDE Adapter 0 Master	Selects the IDE Adapter 0 Master submenu.	[2167 MB]	Displays the capacity of the internal hard drive which is on this interface and when selected opens the submenu which allows you to change the interface specifications to suit your particular hard drive.
IDE Adapter 1 Master	Selects the IDE Adapter 1 Master submenu.	[CD-ROM]	Displays the capacity of the hard drive if there is one on this interface or indicates a CD-ROM drive is installed on this interface. When selected opens the submenu which allows you to change the interface specifications to suit your particular drive. (This is the CD-ROM drive or the optional second hard drive if either is installed in Multi-function Bay 2.)

Table 3-1 Fields, Options and Defaults for the Main Menu

Menu Field	Options	Default	Description
Boot Options	Selects the Boot Options submenu		Pressing the Enter key selects the Boot Options submenu.
System Memory		640 KB	Displays the size of system memory, which is detected automatically and cannot be changed by the setup utility.
Extended Memory		31 MB	Displays the size of extended memory which is detected automatically and cannot be changed by the setup utility.

Configuring Your LifeBook 700 Series

IDE Adapter – Submenu

The IDE Adapter 0 Master or IDE Adapter 1 Master submenus are identical for hard drives. They have the capacity displayed at the top of the screen as well as on Main menu. Follow the instructions for Navigating Through the Setup Utility to make any changes. (See page 55.)

Table 3-2 shows the names of the menu fields for the IDE Adapter submenu, all of the options for each field, the default settings and a description of the field's function and any special information needed to help understand the field's use.

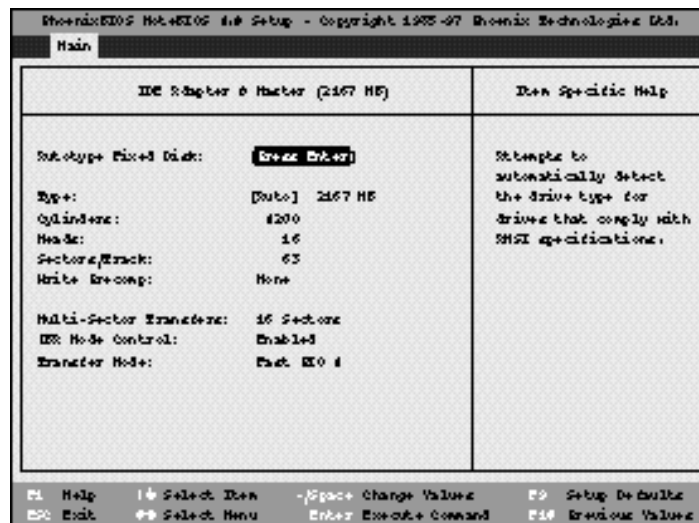


Figure 3-2 IDE Adapter Submenu

Table 3-2 Fields, Options and Defaults for the IDE Adapter Submenu

Menu Field	Options	Default
Autotype Fixed Disk:	[Press Enter]	
Type:	Auto; None; CD; User; 1-14; Rsvr; 16-39	Auto

Description

Selecting this field activates your notebook to search for identification of the drive, if any, which is installed on this interface and determine its characteristics which are then displayed and are not available to change without resetting the Type.

Allows you to configure the interface for almost any drive.



CAUTION

Even if the item help on the right side of the screen suggests that when User is selected that the None selection for Write Precomp: can be chosen by pressing the **N** key. You must use the normal selection method explained in Navigating Through the Setup Utility on page 55.

Cylinders: (Available to change only when Type = User. Displayed for Type = Auto when a hard drive has been detected and Type = any number.)

A number between 0 and 65,535.

Sets the number of cylinders for the drive. This field can be changed by incrementing (pressing the Spacebar) or by typing in the number.

Table 3-2 Fields, Options and Defaults for the IDE Adapter Submenu

Menu Field	Options	Default	Description
Head: (Available to change only when Type = User. Displayed for Type = Auto when a hard drive has been detected and Type = any number.)	A number between 1 and 16.		Sets the number of sectors on the drive. This field can be changed by incrementing (pressing the Spacebar) or by typing in the number.
Sectors/Track: (Available to change only when Type = User. Displayed for Type = Auto when a hard drive has been detected and Type = any number.)	A number between 0 and 63.		Sets the number of cylinders for the drive. This field can be changed by incrementing (pressing the Spacebar) or by typing in the number.
Write Precomp: (Available to change only when Type = User. Displayed for Type = Auto when a hard drive has been detected and Type = any number.)	None; A number between 0 and 65,534		Sets the amount of data compression the interface will use when writing to a hard drive.

Table 3-2 Fields, Options and Defaults for the IDE Adapter Submenu

Menu Field	Options	Default	Description
Multi-Sector Transfers: (Available to change only when Type = User, None, Rsvr, or a number. Displayed for Type = CD or Auto with a hard drive detected.)	Disabled; 2; 4; 8; 16.		Sets the number of sectors allowed in a block transfer.
LBA Mode Control: (Available to change only when Type = User, None, Rsvr, or a number. Displayed for Type = CD or Auto with a hard drive detected.)	Enabled; Disabled.		Enables or disables logical Block Addressing in place of Cylinder, Head, Sector addressing.
Transfer Mode: (Available to change only when Type = User, None, Rsvr, or a number. Displayed for Type = CD or Auto with a hard drive detected.)	Standard, Fast PIO 1 – Fast PIO 4.		Selects the data movement method for the drive.

Configuring Your LifeBook 700 Series



CAUTION

A bootable CD-ROM may have either a floppy disk format or a hard drive format. When the bootable CD-ROM is used the drive allocations change automatically without changing the BIOS setup. If a floppy disk format CD-ROM is used the CD-ROM becomes Drive A. If a hard disk format CD-ROM is used the internal hard drive becomes Drive D and the CD-ROM becomes Drive C and all other drive designations shift as necessary. The boot sequence ignores the new drive designations, however, your application software will use the new designations.



CAUTION

Be careful of the operating environment when booting from a CD-ROM or you may overwrite files by mistake.

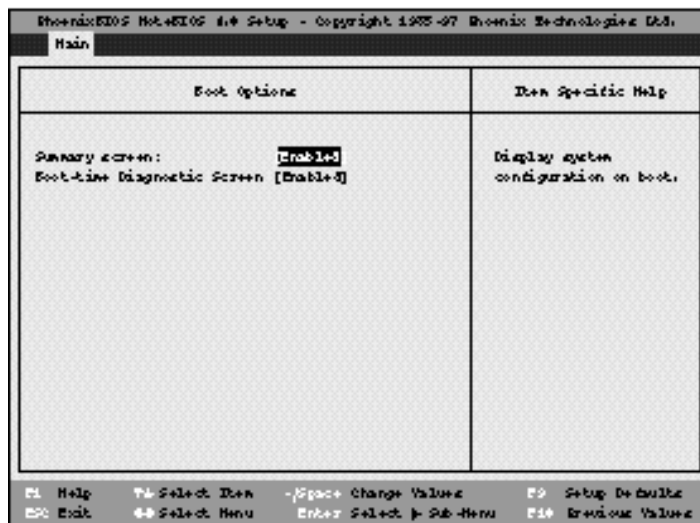


Figure 3-3 Boot Options Submenu

Boot Options Submenu

The Boot Options submenu provides the ability to set the process which your notebook follows when turning on or restarting. Follow the

instructions for Navigating Through the Setup Utility to make any changes. (See page 55.)

Table 3-3 shows the names of the menu fields for the Boot Options submenu, all of the options for each field, the default settings and a description of the field's function and any special information needed to help understand the field's use.

Table 3-3 Fields, Options and Defaults for the Boot Options Submenu

Menu Field	Options	Default	Description
Summary screen:	Enabled; Disabled	Disabled	Enables and disables the display of a screen containing a summary of the configuration of the system. When enabled this screen appears after the completion of Power On Self Test (POST) and before the operating system is loaded.
Boot-time Diagnostic Screen	Enabled; Disabled	Disabled	Enables and disables the display of a screen containing diagnostic information as it is detected by the Power On Self Test (POST).

Exiting from the Main Menu

When you have finished setting the parameters on this menu, you can either exit from the setup utility, or move to another menu. If you wish to exit from the setup utility, press the Esc key or use the cursor keys to go to the Exit

menu. If you wish to move to another menu, use the cursor keys. See *Navigating Through the Setup Utility* on page 55 for more information.

Configuring Your LifeBook 700 Series

ADVANCED MENU – SETTING DEVICE FEATURE CONTROLS

The Advanced Menu allows you to:

- Set the I/O addresses for the serial and parallel ports.
- Set the communication mode for the parallel port.
- Set an audio function I/O address, interrupt level and DMA channel.
- Select between the display panel and an external CRT display.
- Enable or disable compensation for your display.
- Set the I/O address for PCIC.
- Set the docking parameters.

Follow the instructions for Navigating Through the Setup Utility to make any changes. (See page 55.)

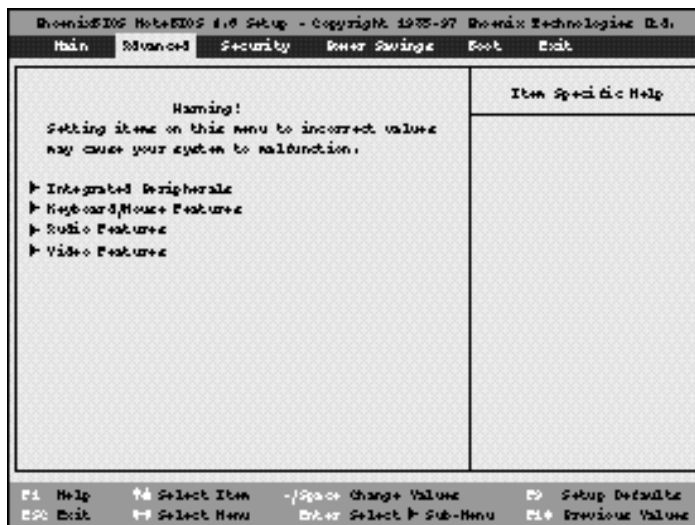


Figure 3-4 Advanced Menu

Table 3-4 shows the names of the menu fields for the Advanced Menu, all of the options for each field, the default settings and a description

of the field's function and any special information needed to help understand the field's use.

Table 3-4 Field Names, Options and Defaults for the Advanced Menu

Menu Field	Options	Default	Description
Integrated Peripherals	-	-	When selected opens the Integrated Peripherals submenu which allows changing of addresses, interrupt levels, etc.
Keyboard/Mouse Features	-	-	When selected opens the Keyboard/Mouse Features submenu, which allows setting external and internal keyboard and mouse parameters.
Audio Features	-	-	When selected opens the Audio Features submenu, which allows setting the hardware address and interrupt levels of audio functions and enabling or disabling the MIDI/joystick port.
Video Features	-	-	When selected opens the Video Features submenu, which allow setting of the display parameters, including routing of video signals to different displays.

Configuring Your LifeBook 700 Series



CAUTION

I/O addresses, DMA channels and Interrupt levels can be entered in various ways, including via the BIOS setup utility, the control software for the I/O device, or the hardware. If any two ports or devices, serial or parallel, have the same I/O address assigned your notebook will not function normally. Please keep a record of original settings before making any changes in the event that a restoration is required. See your hardware and software documentation as well as the setup utility to determine settings, limitations, etc.

Integrated Peripherals Submenu of the Advanced Menu

The Integrated Peripherals submenu provides the ability to set the I/O addresses and interrupt levels for ports of your notebook. Follow the instructions for Navigating Through the Setup Utility to make any changes. (See page 55.)

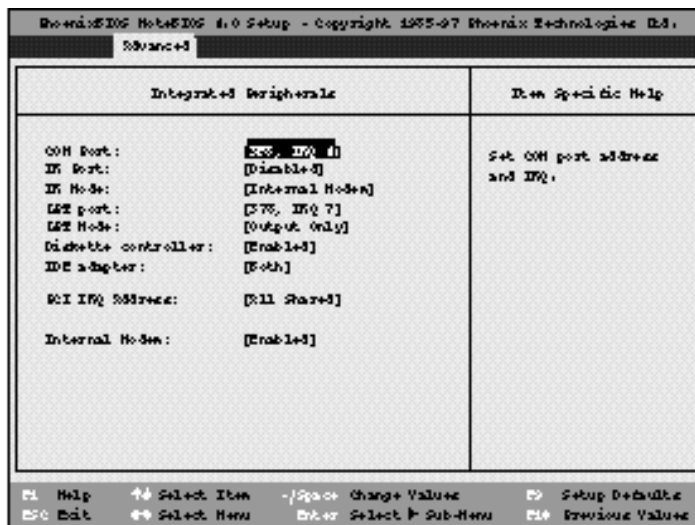


Figure 3-5 Integrated Peripherals Submenu

Table 3-5 shows the names of the menu fields for the Integrated Peripherals submenu, all of the options for each field, the default settings

and a description of the field's function and any special information needed to help understand the field's use.

 **POINT**

All I/O addresses in Table 3-5 are in hexadecimal.

Table 3-5 Fields, Options and Defaults for the Integrated Peripherals Submenu

Menu Field	Options	Default	Description
COM Port:	3F8, IRQ 4; 2F8,IRQ 3; 3E8,IRQ 4; 2E8,IRQ 3; 3F8,IRQ 11; 2F8,IRQ 10; 3E8,IRQ 11;2E8, IRQ 10; Disabled	3F8, IRQ 4	Sets the serial port address and interrupt level.
IR Port	3F8, IRQ 4; 2F8,IRQ 3; 3E8, IRQ 4; 2E8,IRQ 3; 3F8,IRQ 11; 2F8,IRQ 10;3E8, IRQ 11; 2E8,IRQ 10; Disabled	Disabled	Sets the infrared port address and interrupt level.
IR Mode:	Standard; Fast,DMA CHANNEL 1; Fast,DMA CHANNEL 3	Standard	Sets the infrared port mode.

Configuring Your LifeBook 700 Series

Table 3-5 Fields, Options and Defaults for the Integrated Peripherals Submenu

Menu Field	Options	Default	Description
LPT Port:	278,IRQ 7; 378,IRQ 7; 3BC,IRQ 7; 278,IRQ 5; 378,IRQ 5; 3BC,IRQ 5; Disabled	378, IRQ 7	Sets the parallel port address and interrupt level.
LPT Mode:	Bi-Directional; ECP, DMA CHANNEL 1; ECP, DMA CHANNEL 3; Output Only	Bi-Directional	Sets the parallel port mode: Bi-directional (Full Duplex); two-way transfer of information between your notebook and a connected parallel device. Example: if your notebook is connected to a parallel printer, it can transfer data and control information to the printer, and the printer can transfer back status and error information to your notebook; Output Only (Half Duplex); information transferred in only one direction, from your notebook to the printer or similar device;ECP Mode allows communication with the ECP class of parallel I/O devices.
Diskette Controller:	Enabled; Disabled	Enabled	Enables and disables the floppy disk drive controller for both multi-function bays and the external floppy disk drive port.
IDE Adapter:	Both; Disabled; Primary; Secondary	Both	Enables and disables the IDE adapters for both multi-function bays.

Table 3-5 Fields, Options and Defaults for the Integrated Peripherals Submenu

Menu Field	Options	Default	Description
PCI IRQ Routing:	Disabled; Auto select; IRQ3; IRQ4;IRQ5; IRQ7; IRQ9;IRQ10; IRQ11	Auto select	Sets how the PCI interrupt will be routed.
Internal Modem:	Enabled; Disabled	Enabled	Enables and disables the internal modem.

Configuring Your LifeBook 700 Series

Keyboard/Mouse Features Submenu

The Keyboard/Mouse Features submenu is for setting the parameters of the integrated and external mouse and keyboard. Follow the instructions for Navigating Through the Setup Utility to make any changes. (See page 55.)

Table 3-6 shows the names of the menu fields for the Keyboard/Mouse submenu, all of the options for each field, the default settings and a description of the field's function and any special information needed to help understand the field's use.

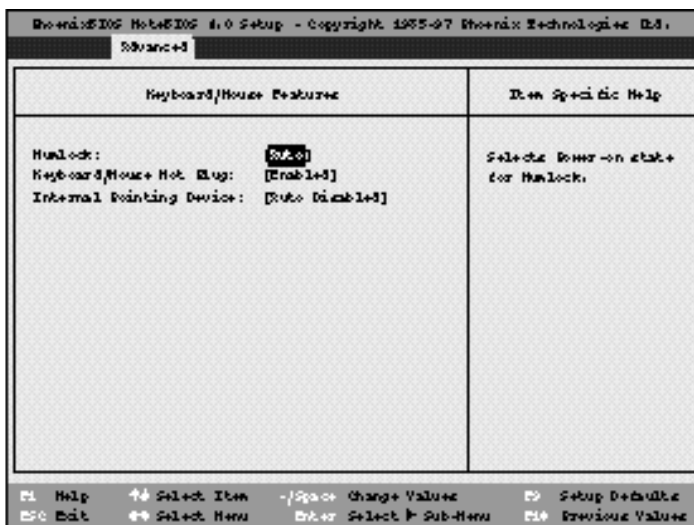


Figure 3-6 Keyboard/Mouse Features Submenu

Table 3-6 Fields, Options and Defaults of the Keyboard/Mouse Submenu of the Advanced Menu

Menu Field	Options	Default	Description
Numlock:	Off;On; Auto	Auto	Sets the NumLock function state when the computer completes booting.
Keyboard/Mouse Hot Plug:	Enabled; Disabled	Enabled	Enables and disables the ability to plug a mouse or keyboard into the PS/2 port and have it immediately recognized and active.
Internal Pointing Device:	Auto Disabled; Always Enabled	Auto Disabled	Sets the device controlling the mouse cursor on the screen. Always Enabled makes the ErgoTrac pointing device always enabled whether there is an external mouse or not. Auto Disabled makes the ErgoTrac pointing device turn off when an external pointing device is connected to the PS/2 port.

Configuring Your LifeBook 700 Series

Audio Features Submenu

The Audio Features Submenu is for setting the features of the built-in audio functions. Follow the instructions for Navigating Through the Setup Utility to make any changes. (See page 55.)

Table 3-7 shows the names of the menu fields for the Audio Features submenu, all of the options for each field, the default settings and a description of the field's function and any special information needed to help understand the field's use.



POINT

All I/O addresses in Table 3-7 are in hexadecimal.

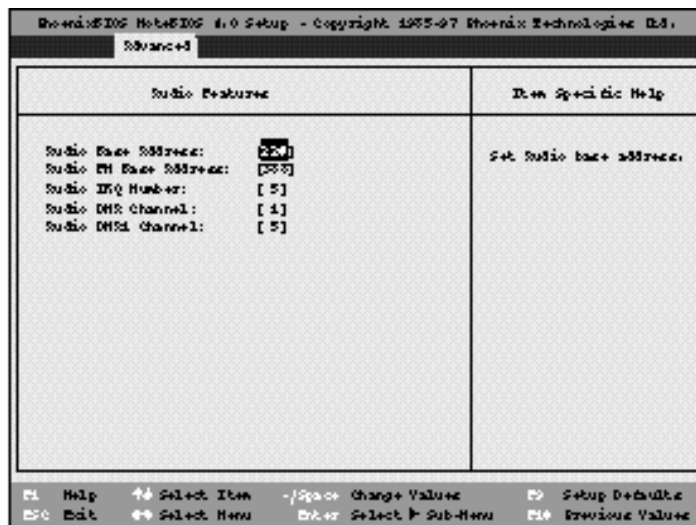


Figure 3-7 Audio Features Submenu

Table 3-7 Fields, Options and Defaults of the Audio Features Submenu of the Advanced Menu

Menu Field	Options	Default	Description
Audio Base Address:	220; 240; 260; 280; Disabled	220	Sets the base address for audio functions. When set to Disabled no other audio addressing is operational or accessible.
Audio FM Base Address:	388; 38C; 390; 394	388	Sets the base address for FM synthesizer functions.
Audio IRQ Number:	5; 7; 9; 10; 11	5	Sets the interrupt level for audio functions.
Audio DMA0 Channel:	0; 1; 3; 5	1	Sets the DMA0 audio channel.
Audio DMA1 Channel:	None; 0; 1; 3; 5	5	Sets or disables the DMA1 audio channel.

Configuring Your LifeBook 700 Series

Video Features Submenu

The Video Features Submenu is for setting the display parameters. Follow the instructions for [Navigating Through the Setup Utility](#) to make any changes. (See page 55.)

Table 3-8 shows the names of the menu fields for the Video Features submenu, all of the options for each field, the default settings and a description of the field's function and any special information needed to help understand the field's use.

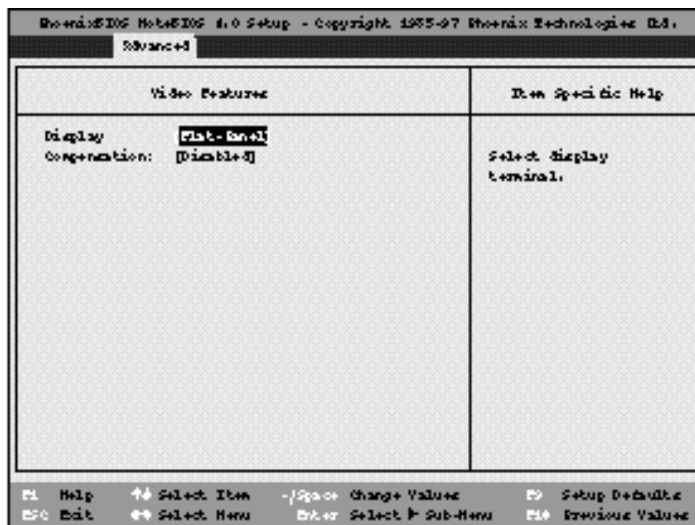


Figure 3-8 Video Features Submenu

Table 3-8 Fields, Options and Defaults for the Video Features Submenu of the Advanced Menu

Menu Field	Options	Default	Description
Display:	Flat-Panel; CRT; Simultaneous	Flat-Panel	Selects where the video signal will be routed.
Compensation:	Enabled; Disabled	Disabled	Enables or disables compensation which controls spacing on the display. When it is enabled displays with less than 800 x 600 pixel resolution will still cover the entire screen.

Exiting from the Advanced Menu

When you have finished setting the parameters on the Advanced Menu, you can either exit from setup utility or move to another menu.

If you wish to exit from setup utility, press the Esc key to go to the Exit menu. If you wish to move to another menu, use the cursor keys.

Configuring Your LifeBook 700 Series

SECURITY MENU – SETTING THE SECURITY FEATURES

The Security menu allows you to set up the data security features of your notebook to fit your operating needs and to view the current data security configuration. Follow the instructions for Navigating Through the Setup Utility to make any changes. (See page 55.)

Table 3-9 shows the names of the menu fields for the Security menu, all of the options for each field, the default settings and a description of the field's function and any special information needed to help understand the field's use. The default condition is no passwords required and no write protection.

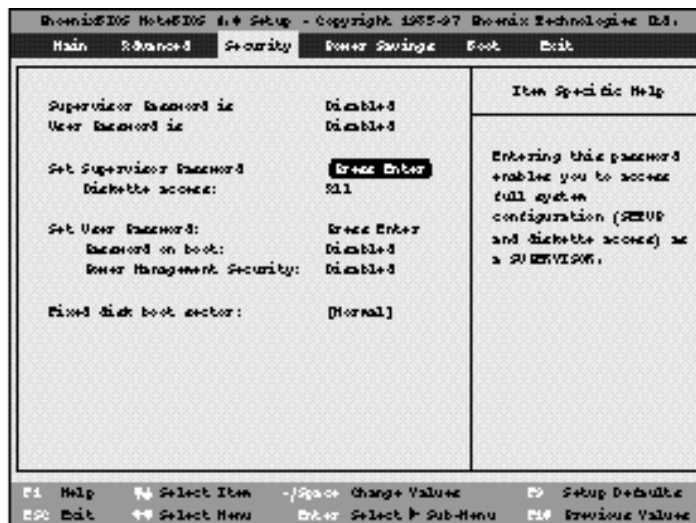


Figure 3-9 Security Menu

 **POINT**

If you set a password, write it down and keep it in a safe place. If you forget the password you will have to contact your support representative to regain access to your secured functions and data.

 **POINT**

If you make an error when reentering the password a [Warning] will be displayed on the screen. To try again press the **Enter** key and then retype the password. Press the **Esc** key to abort the password setting process.

 **CAUTION**

Entering a password incorrectly 3 times in a row will cause the keyboard and mouse to be locked out and the warning [System Disabled] to be displayed. If this happens restart the computer by turning off and on the power with the power switch and use the correct password on reboot.

 **CAUTION**

If the Power Management Security is Enabled and the Password on Boot is Disabled you will not be able to resume operation from the Suspend or Save-to-Disk modes.

Table 3-9 Fields, Options and Defaults for the Security Menu

Menu Field	Options	Default	Description
Supervisor Password is:	–	Disabled	A display-only field. Enabled is displayed when the system supervisor password is set and Disabled when it is not.
User Password is:	–	Disabled	A display-only field. Enabled is displayed when the general user password is set, and Disabled when it is not.
Set Supervisor Password:	[Press Enter]	–	Sets, changes or cancels the Supervisor Password. The Supervisor Password may be up to seven characters long and must include only lower-case letters or numbers. To cancel a password press the Enter key instead of entering characters in the Enter New Password field and in the Re-enter New Password field. When a Supervisor Password is set it must be used to access the BIOS setup utility.
Diskette access:	All; Supervisor Only	All	Sets the floppy disk access to be secured for access only with Supervisor's password or by all users with a password. The default is Supervisor Only but if no Supervisor password is set it will not be secured at all.
Set User Password:	[Press Enter]	–	Sets, changes or cancels the User Password. The User Password may be up to seven characters long and must include only lower case letters or numbers. To cancel a password press the Enter key instead of entering characters in the Enter New Password field and in the Re-enter New Password field. When a User Password is set it must be used to access the BIOS setup utility.

Table 3-9 Fields, Options and Defaults for the Security Menu

Menu Field	Options	Default	Description
Password on Boot:	Enabled; Disabled	Disabled	When set to Enabled, a password (User or Supervisor) is required after the Power On Self Test (POST) before the operating system will be read from a disk. When set to Disabled no password is required. If no Supervisor Password is set this feature is not available and no password is required.
Power Management Security:	Enabled; Disabled	Disabled	When set to Enabled, a password (User or Supervisor) is required to resume from Suspend or Save-to-Disk mode. The password required is the same one required by the Password on Boot function.
Fixed Disk Boot Sector:	Normal; Write Protect	Normal	Sets write protection for the sector of the boot disk which contains the operating system. When set to Write Protect, the BIOS will prevent any application from writing into the sector of the internal hard drive containing the operating system. When set to Normal there is no BIOS protection of the operating system.

**POINT**

Boot Sector Protection must be set to Normal to load or upgrade an operating system.

Exiting from the Security Menu

When you have finished setting the parameters on the Security Menu, you can either exit from setup utility or move to another menu. If you

wish to exit from setup utility, press the Esc key to go to the Exit Menu. If you wish to move to another menu, use the cursor keys.

Configuring Your LifeBook 700 Series

POWER SAVINGS MENU – SETTING POWER MANAGEMENT FEATURE CONTROLS

The Power Savings menu allows you to set and change the power management parameters. Follow the instructions for Navigating Through the Setup Utility to make any changes. (See page 55.)

Table 3-10 shows the names of the menu fields for the Power Savings menu, all of the options for each field, the default settings and a description of the field's function and any special information needed to help understand the field's use.



POINT

Most power management parameters can also be set from the Windows 95 desktop without entering the setup utility, using PowerPanel by Phoenix Technologies.

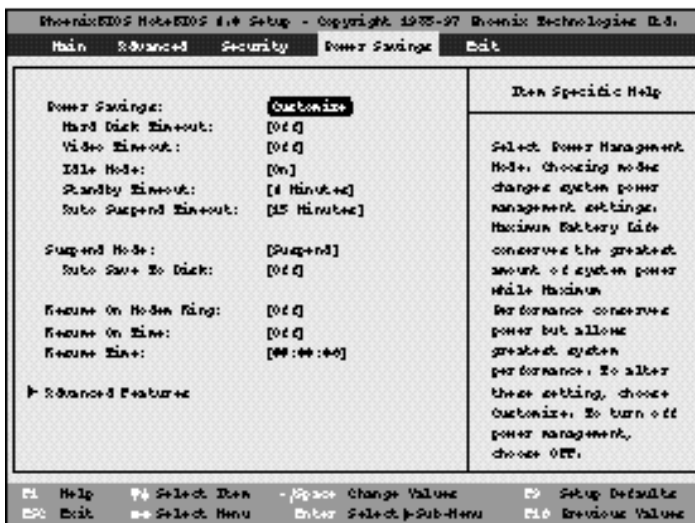


Figure 3-10 Power Savings Menu

Table 3-10 Fields, Options and Defaults for the Power Savings Menu.

Menu Field	Options	Default	Description
Power Savings:	Customize; Maximum Performance; Maximum Battery Life; Off	Customize	Sets the power savings parameters to a factory installed combination of parameters, a custom set of parameters set by you or no power saving features.
Hard Disk Timeout:	30 seconds to 20 minutes; Off	Off	Sets the length of time that the hard drive can be inactive before your notebook automatically turns off the power to the hard drive controller and drive motor. If you choose a factory installed combination of parameters this field will display the setting. If you choose to customize the parameters you will be able to set this yourself. The options available vary from Off, which has no inactivity shutoff, to 20 minutes.
Video Timeout:	30 seconds to 20 minutes; Off	Off	Sets the length of time without any user input device activity before the display is turned off. If you choose a factory combination of parameters, this field will display the setting. If you choose to customize the parameters, you will be able to set this yourself. Off has no inactivity shutoff.

Table 3-10 Fields, Options and Defaults for the Power Savings Menu.

Menu Field	Options	Default	Description
Idle Mode:	On; Off	On	Turns on and off the slow down of the CPU during periods of inactivity. When this is turned on the CPU clock slows by the amount set in the Advanced submenu when there is no activity for 16 seconds or more. Normal speed resumes automatically as soon as there is any activity.
Standby Timeout:	1 minute to 16 minutes;Off	4 Minutes	Sets the length of time without any user input device activity before the CPU is set to half speed and the display and the hard drive are turned off. If you choose a factory combination of parameters this field will display the setting. If you choose to customize the parameters you will be able to set this yourself.
Auto Suspend Timeout:	5 to 60 minutes;Off	15 Minutes	Sets the length of time without any I/O activity before your notebook goes into Suspend mode. If you choose a factory combination of parameters this field will display that setting. If you choose to customize the parameters you will be able to set this yourself. Off has no inactivity suspension.

Table 3-10 Fields, Options and Defaults for the Power Savings Menu.

Menu Field	Options	Default
Suspend Mode:	Suspend; Save-to-Disk	Suspend

Description

Sets the form of suspension state. If you choose Suspend, you will suspend operation with power to system memory, and everything else powered down or in a very low power state. If you choose Save-to-Disk your notebook will save all of system memory and the operating parameters to the hard drive before turning your notebook to the pseudo-off condition.

 POINT

When resuming from a Save-to-Disk suspension there will be a delay while the contents of system memory and operating parameters are loaded from the hard drive.

 CAUTION

In Save-to-Disk mode there is no indication on the Status Indicator to let you know you are suspended rather than shut off from the power switch. You may want to make a habit of always trying the Suspend/Resume button before using the power switch.

Auto Save to Disk:	Off; After 1 Hour	Off
--------------------	-------------------	-----

When set to After 1 Hour your notebook will automatically save all of system memory and the operating parameters to the hard drive and go to the pseudo-off if you leave your notebook in Suspend mode for an hour.

Resume On Modem Ring:	On; Off	Off
-----------------------	---------	-----

Sets whether or not to Resume from a suspension state when a message is received by telephone line. This feature is not available if the Save-to-Disk mode is enabled. This feature applies to internal, external and PC Card modems.

Configuring Your LifeBook 700 Series

Table 3-10 Fields, Options and Defaults for the Power Savings Menu.

Menu Field	Options	Default	Description
Resume On Time:	On; Off	Off	Sets whether or not to resume from a suspension state at a designated time. This feature is available from either the Suspend mode or the Save-to-Disk mode.
Resume Time:	–	–	Sets the designated time, on a 24-hour clock, when the notebook is to automatically resume operation from the Suspend state. The format of the clock setting is hours:minutes:seconds. Each segment of the time is set separately, either by incrementing or by typing in the numbers. You move between the segments with the Tab key or the Shift+Tab keys. This only applies when Resume on Time is set to On.
Advanced Features	–	–	When selected, opens the Advanced Features submenu which allows setting additional power saving parameters.

Factory Installed Values for Power Saving Profiles

Profile	Hard Disk Timeout	Video Timeout	Idle mode	Standby mode	Auto Suspend mode
Customize	Off	Off	Off	4 Minutes	15 Minutes
Maximum Performance	Off	Off	Off	Off	15 Minutes
Maximum Battery Life	30 Seconds	2 Minutes	On	1 Minute	5 Minutes
Off	Off	Off	Off	Off	Off

Advanced Features Submenu

The Advanced Features submenu is for setting some non-time related power saving parameters. Follow the instructions for Navigating Through the Setup Utility to make any changes. (See page 55.)

Table 3-11 shows the names of the menu fields for the Video Features submenu, all of the options for each field, the default settings and a description of the field's function and any special information needed to help understand the field's use.

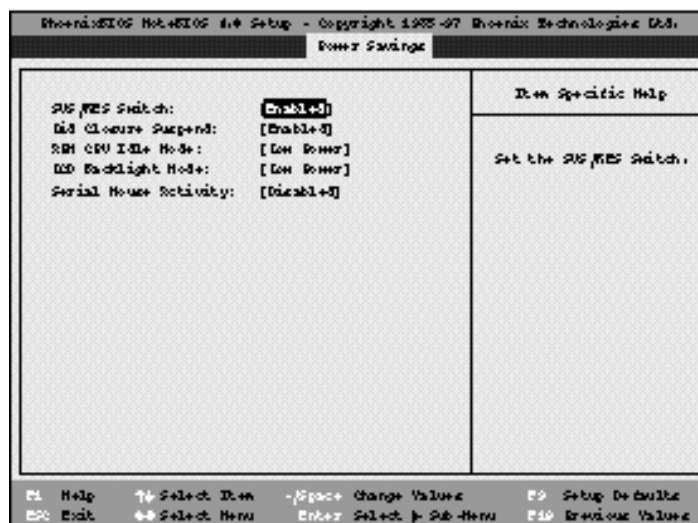


Figure 3-11 Advanced Features Submenu

Table 3-11 Fields, Options and Defaults for the Advanced Features Submenu of the Power Savings Menu

Menu Field	Options	Default	Description
SUS/RES Switch:	Enabled; Disabled	Enabled	Turns off and on the suspend function of the Suspend/Resume button. The resume function can not be disabled.
Lid Closure Suspend:	Enabled; Disabled	Enabled	Enables and disables having closure of the Display panel put your notebook in Suspend mode.
AMU CPU Idle Mode:	Low Power; Standard	Low Power	Sets the CPU speed during Idle mode.
LCD Backlight Mode:	Low Power; Standard	Low Power	Sets the CPU speed during Video timeout and Lid Closure Suspend activation.
Serial Mouse Activity:	Enabled; Disabled	Disabled	Enables and disables having activity on the serial port cause the system to reactivate from inactivity timeouts.

Exiting from the Power Savings Menu

When you have finished setting the parameters on the Power Savings menu, you can either exit from the setup utility or move to another menu.

If you wish to exit from the setup utility press the Esc key to go to the Exit menu. If you wish to move to another menu, use the cursor keys.

BOOT MENU – SELECTING THE OPERATING SYSTEM SOURCE

The Boot Menu is used to select the order in which the BIOS searches sources for the operating system.

Table 3-12 shows the names of the menu fields for the Boot menu, all of the options for each field, the default settings and a description of the field's function and any special information needed to help understand the field's use.

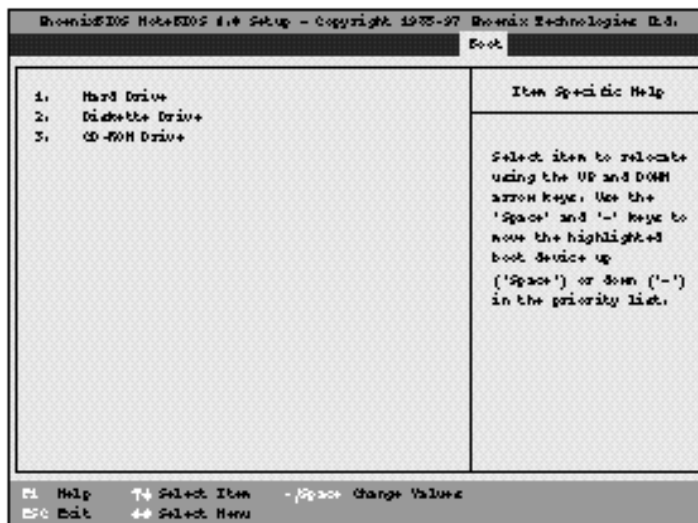


Figure 3-12 Boot Menu

Table 3-12 Fields, Options and Defaults for the Boot Menu.

Menu Field	Options	Default	Description
1. Hard Drive	-	-	The boot selections determine the order in which the BIOS searches for the operating system during a startup sequence. To change the order highlight one source by using the up ↑, down ↓ cursor keys and then press the + or - key to change the order number for that source. Be sure to save your changed order when you exit the BIOS setup utility.
2. Diskette Drive	-	-	
3. CD-ROM Drive	-	-	

Exiting from Boot Menu

When you have finished setting the search sequence order with the Boot menu, you can either exit from the setup utility or move to another menu. If you wish to exit from the setup utility press the Esc key to go to the Exit menu. If you wish to move to another menu, use the cursor keys.

EXIT MENU – LEAVING THE SETUP UTILITY

The Exit Menu is used to leave the setup utility. Follow the instructions for Navigating Through the Setup Utility to make any changes. (See page 55.)

Table 3-13 shows the names of the menu fields for the Exit menu, all of the options for each field, the default settings and a description of the field's function and any special information needed to help understand the field's use.

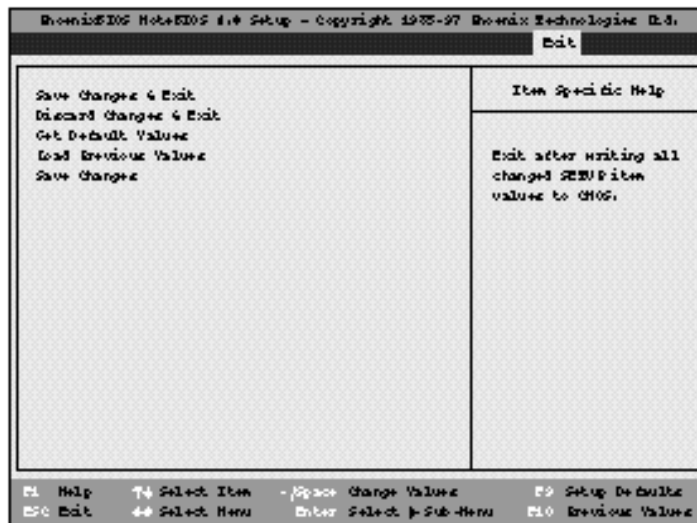


Figure 3-13 Exit Menu

Table 3-13 Fields, Options and Defaults for the Exit Menu.

Menu Field	Options	Default	Description
Save Changes and Exit:	-	-	Selecting Save Changes and Exit will store all the entries on every menu of the setup utility to the BIOS memory and then exit the setup utility. A confirmation message Save Configuration Changes and Exit Now? [Yes] [No] will be displayed.
Discard Changes and Exit:	-	-	Selecting Discard Changes and Exit will exit the setup utility with out writing to the BIOS memory. When the BIOS recognizes this selection it will load the operating system and begin operation. A message Setup Warning Configuration Changes have not been saved. Save before exiting? [Yes] [No] will be displayed.
Get Default Values:	-	-	Selecting Get Default Values will load the factory preset default values for all menu fields, then display the message Setup Confirmation Load Default values now? [Yes] [No] When confirmed the setup utility will return to the Exit Menu. To return to another menu follow the directions in the Navigating Through the Setup Utility Section. (See page 55.)

Table 3-13 Fields, Options and Defaults for the Exit Menu.

Menu Field	Options	Default	Description
Load Previous Values:	-	-	Selecting Load Previous Values will load the values in BIOS memory for all menu fields. Setup Confirmation Load Previous values now? [Yes] [No] When confirmed the setup utility will return to the Exit menu. To return to another menu, follow the directions in the Navigating Through the Setup Utility Section. (See page 55.)
Save Changes:	-	-	Selecting Save Changes will cause the new settings in all menus to be written to the BIOS memory. Setup Confirmation Save Changes now? [Yes] [No] When confirmed the setup utility will return to the Exit menu. To return to another menu, follow the directions in the Navigating Through the Setup Utility Section. (See page 55.)

SETTING UP YOUR SAVE-TO-DISK FILE ALLOCATION

Your notebook comes with an allocation of space on the internal hard drive adequate to operate the Save-to-Disk function for the amount of memory installed at the factory. If you add a memory upgrade module or do not use the Save-to-Disk function and wish to free up the disk space, you will need to change your allocation. The utility to change the allocations is PHDISK.EXE and is activated from the MS-DOS prompt.

PHDISK allows you to perform five different functions related to the Save-to-Disk space on your internal hard drive. They are:

1. Allocate a space for the Save-to-Disk function.
2. Remove all space allocation for the Save-to-Disk function.
3. Find out details about the hard drive and the current Save-to-Disk space allocation.
4. Re-allocate space and mark bad blocks in the space allocated to the Save-to-Disk function when a disk error has occurred.
5. Find out how much space is needed to perform the Save-to-Disk function with the current memory configuration and how much unused space is available on the internal hard drive.

To find out how much space is needed to perform the Save-to-Disk function with the current memory configuration and how much unused space is available on the internal hard drive, do the following:

1. Restart your notebook in MS-DOS mode.
2. At the DOS prompt type CD C:\Fujitsu
3. Type PHDISK.
4. Press the Enter key.
5. The screen will display the amount disk space needed to perform the Save-to-Disk function with the current memory configuration and how much unused space is available on the internal hard drive.

To find out details about the hard drive and the current Save-to-Disk space allocation, do the following:

1. Restart your notebook in MS-DOS mode.
2. At the DOS prompt type CD C:\Fujitsu.
3. Type PHDISK/INFO.
4. Press the Enter key.
5. The screen will display the size of the space currently allocated to the Save-to-Disk function and other parameters about the space and the hard drive.

To remove all space allocation for the Save-to-Disk function, do the following:

1. Go to the Start Menu and select MS-DOS Prompt.
2. Type CD C:\Fujitsu.
3. Type PHDISK \DELETE \FILE.
4. Press the Enter key.

5. The utility will remove the space allocation for the Save-to-Disk function and free that space for other use.

To create a space allocation for the Save-to-Disk function, do the following:

1. Restart your notebook in MS-DOS mode.
2. At the DOS prompt type **PHDISK \CREATE \FILE**.
3. Press the Enter key.
4. The utility will create a Save-to-Disk file called **SAVE2DSK.BIN** in the root directory. It will be of the minimum size needed to support the Save-to-Disk function with the current memory configuration.

If you have had a read or write error when you tried to perform a Save-to-Disk operation you can re-allocate space to compensate for bad blocks on your drive. To do this:

1. Go to the MS-DOS prompt.
2. Type **PHDISK \REFORMAT \FILE**.

3. Press the Enter key.

4. The utility will re-create the Save-to-Disk file called **SAVE2DSK.BIN** with the same usable size and any bad blocks marked.



CAUTION

Never use **PARTITION** in place of **FILE** with the PHDISK Utility or you will reformat your internal hard drive and all data, applications and operating system will be destroyed.

User Installable Features

Multi-function Bay Devices	97
PC Cards	103
Parallel Port Devices	105
Serial Port Devices	105
USB Devices	105
Microphone	105
Stereo Line In Devices	105
Headphones	105
Telephone Lines	106
Mouse or Keyboard	106
External Monitor	106
Theft Prevention Lock	106
External Installation of a Floppy Disk Drive	107
Memory Upgrade Module	108
LANdock	111
Port Replicator	115

SECTION FOUR

USER INSTALLABLE FEATURES

Your LifeBook 700 Series has a number of user installable features:

- PC Card slots in the left side panel of your notebook allow you to install PC Cards, IC memory cards (SRAM card) or Zoomed Video cards (Slot 0 only).
- The dual Multi-function bays in the front of your notebook allow you to install the CD-ROM drive, the floppy disk drive, an optional second hard drive, or an optional second Lithium ion battery.
- A compartment on the bottom of your notebook allows you to install a memory upgrade module.
- A microphone jack on the right side of your notebook allows you to connect a mono microphone.
- A stereo line in jack on the right side of your notebook allows you to connect a sound source such as a cassette recorder.
- A headphone jack on the right side of your notebook allows you to connect headphones or powered speakers.
- A PS/2 port on the right side of your notebook allows you to connect an external mouse, keyboard or numeric keypad.
- An external floppy disk drive port on the right side of your notebook allows you to attach an external floppy disk drive when the Multi-function bays are being used for other purposes.
- A USB port in the right side of your notebook allows you to connect a Universal Serial Bus device.
- An RJ-11 jack in the back of your notebook allows you to connect a telephone line to the internal modem.
- A docking port on the back of your notebook allows the connection of a docking device.
- A serial port in the back of your notebook allows you to connect serial devices, such as RS-232C serial printers or scanners.
- A parallel port in the back of your notebook allows you to connect a parallel printer, photo or text scanner, etc.
- An external monitor port in the back of your notebook allows you to connect an external monitor.

This section describes how to install and remove equipment for each of the expansion features.

User Installable Features

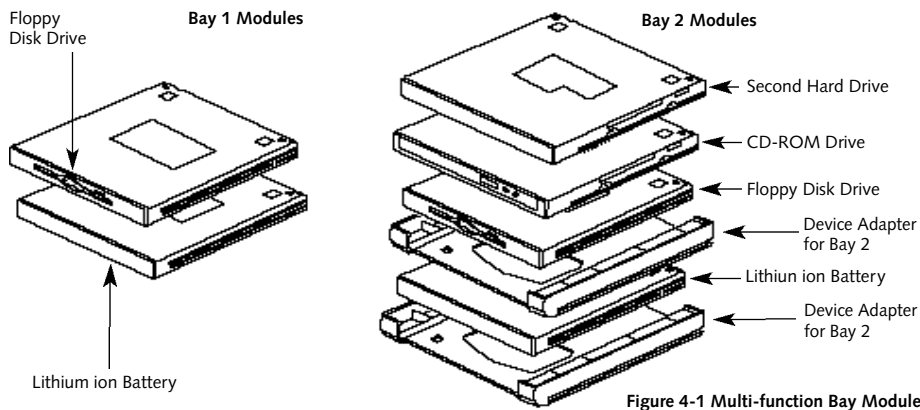


Figure 4-1 Multi-function Bay Modules

MULTI-FUNCTION BAY DEVICES

The bays in the front panel of your notebook accommodate the CD-ROM drive, the floppy disk drive, the Lithium ion batteries (a second battery is optional) or the optional second hard drive.



CAUTION

Do not use your notebook with either of the Multi-function bays empty. It may damage your notebook.



CAUTION

All Multi-function bay devices except the Lithium ion battery must be installed and removed with the power switch in the Off position. The Lithium ion battery may be warm swapped (power on but unit in Suspend mode). (See *Power Off* on pages 24-25 and *Bridge Battery* on page 27.)

The Multi-function bays support a variety of configurations.

Multi-function Bay 1 supports:

- 3.5" floppy disk drive (included with your notebook.)
- Lithium ion battery (included with your notebook.)

Multi-function Bay 2 supports:

- 20-speed maximum CD-ROM drive (included with your notebook.)
- Optional second hard drive.

- **3.5" floppy disk drive installed in Device Adapter for Multi-function Bay 2.**
(Adapter included with your notebook.)
- **Lithium ion battery installed in Device Adapter for Multi-function Bay 2.**
(Adapter included with your notebook.)

The Lithium ion battery included with your notebook can power your notebook from either bay. Your notebook also supports a dual battery configuration with a Lithium ion battery in both bays at the same time. (The optional second battery must be purchased separately.) It does not support multiple floppy disk drives, but has three different places to install one.

To Install or Remove a Device in Multi-function Bay 1.

1. Close all files and exit all applications.
2. Turn off power to your notebook, close the display and remove the AC adapter. (See *Power Off* on pages 24-25.)
3. Turn your notebook upside down with the bay openings toward you.

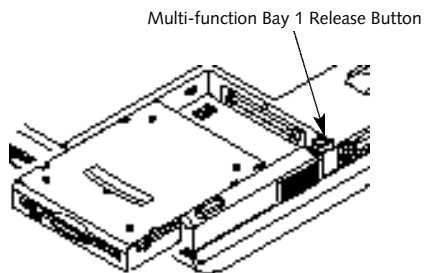


Figure 4-2 Removing and Installing a Device in Multi-function Bay 1

To Remove a Device from Multi-function Bay 1

4. Slide the release latch at the right rear corner of Multi-function Bay 1 toward the outer edge of your notebook.
5. Slide the device forward until the unit is clear of the compartment. This will require some force. Use the finger ridge on the bottom of the device.

To Install a Device in Multi-function Bay 1

4. Orient the item to be installed with the finger ridge away from the body of your notebook and the connector toward the body of your notebook.
5. With the module connector toward the back of your notebook align the grooves on the side of the device with the tracks in the side of the bay. (Figure 4-2.)
6. Slide the module toward the back of your notebook until it clicks into place.



CAUTION

Be careful aligning and seating modules in the bay. If the fit is incorrect you may damage the bay or the module. If the module does not move easily, remove it, and check for dirt or foreign objects. It will require a firm push to latch the module in place.

User Installable Features

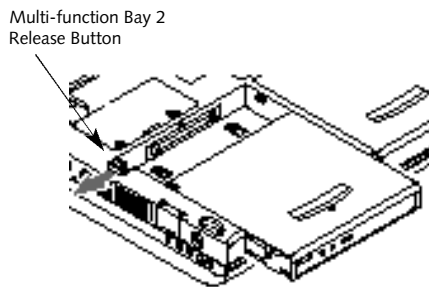


Figure 4-3 Removing and Installing a Device in Multi-function Bay 2

To Install or Remove a Device in Multi-function Bay 2.

1. Close all files and exit all applications.
2. Turn off power to your notebook, close the display and remove the AC adapter. (See pages 24-25 for more information.)
3. Turn your notebook upside down with the bay openings toward you.

To Remove a Device from Multi-function Bay 2

4. Slide the release latch at the left rear corner of Multi-function Bay 2 toward the outer edge of your notebook.
5. Slide the device forward until the unit is clear of the compartment. This will require some force. Use the finger ridge on the bottom of the device.

To Install a Device in Multi-function Bay 2

4. Orient the item to be installed with the finger ridge away from the body of your notebook and the connector toward the body of your notebook.
5. With the module connector toward the back of your notebook align the grooves on the side of the device with the tracks in the side of the bay. (Figure 4-3.)
6. Slide the module toward the back of your notebook until it clicks into place.

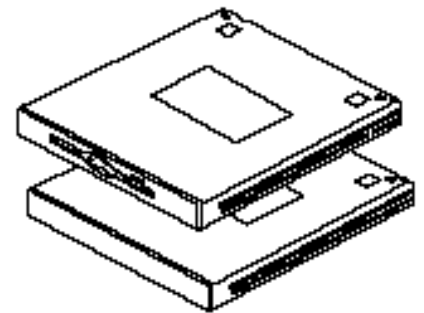


Figure 4-4 Installing a Module in the Device Adapter for Multi-function Bay 2

To Install a Module in the Device Adapter for Multi-function Bay 2.

1. Align the device adapter for Multi-function Bay 2 with the solid side up and the rounded edges toward you.
2. Align your Multi-function Bay 1 device with the finger ridge up and the connector away from you.

3. Set the device adapter for Multi-function Bay 2 on top of the Multi-function Bay 1 device and adjust until the finger ridge shows through the hole in the device adapter for Multi-function Bay 2, and the alignment pins on the Multi-function Bay 1 device fit in the small round holes of the device adapter for Multi-function Bay 2.

4. Hold the two parts together while installing in Multi-function Bay 2 according to the preceding directions.

To remove a module from the device adapter for Multi-function Bay 2 simply pull them gently apart.



CAUTION

The module is not locked into the Device Adapter for Multi-function Bay 2. Be careful to hold on to both parts or you can easily drop and damage a module or the adapter.

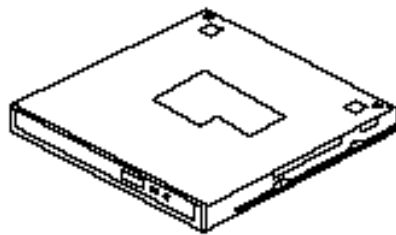


Figure 4-5 CD-ROM Drive

CD-ROM Drive

Your CD-ROM drive is durable but you must treat it with care. Please pay attention to the following points:

- The drive rotates the compact disk at very high speed. Do not carry it around or subject it to shock or vibration with the power on.
- Avoid using or storing the drive or CDs where they will be exposed to extreme temperatures.
- Avoid using or storing the drive or CDs where it is damp or dusty.

- Avoid using or storing the drive near magnets or devices that generate strong magnetic fields.
- Avoid storing the drive where it will be subjected to shock or vibration.
- Do not disassemble or dismantle the CD-ROM drive.

For guidance on loading a CD in your CD-ROM drive and caring for CD-ROMs see Section Two. (pages 36-37.)

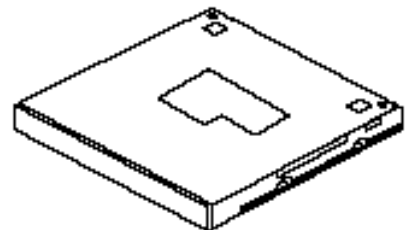


Figure 4-6 Optional Second Hard Drive

User Installable Features

**CAUTION**

The CD-ROM Drive must be installed or removed with the power off.

Optional Second Hard Drive

The optional second hard drive is durable but you must treat it with care. Please pay attention to the following points:

- The drive rotates the disk at very high speed. Do not carry it around or subject it to shock or vibration with the power on.
- Avoid using or storing the drive where it will be exposed to extreme temperatures.
- Avoid using or storing the drive where it is damp or dusty.
- Avoid using or storing the drive near magnets or devices that generate strong magnetic fields.
- Avoid storing the drive where it will be subjected to shock or vibration.

- Do not disassemble or dismantle the hard disk drive.

After the optional second hard drive is installed it will take a short time for your notebook to recognize it.

You will need to format your optional second hard drive when you install it for the very first time. Check your operating system documentation for information on initializing a hard drive. Be careful to only format your optional second hard drive once or you will erase everything you have stored on it.

**CAUTION**

The optional second hard drive must be installed or removed with the power off.

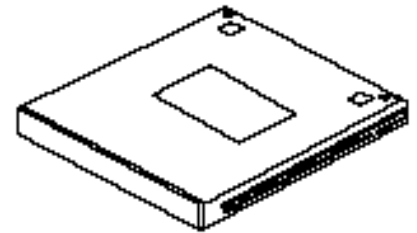


Figure 4-7 Lithium ion Battery

Lithium ion Battery

Your Lithium ion battery is durable and long lasting but should not be exposed to extreme temperatures, high voltages, chemicals or other hazards.

**CAUTION**

If the Lithium ion battery connector is not fully seated, you may not be able to use your notebook or charge your battery.

The battery may be installed singly in either bay, using the device adapter for Multi-function Bay 2. With the purchase of an additional battery, batteries may be installed in a dual configuration, one in each bay. A bridge battery allows a charged Lithium ion battery to be exchanged for a discharged one by "warm-swapping". To warm-swap, have a charged battery ready to install, put your notebook in Suspend mode, remove the low battery and quickly insert the charged battery. The NiCd bridge battery is built-in your notebook and is constantly being charged. The bridge battery capacity is not large, about 3 minutes, and can vary with the condition of your notebook. (See page 27.)

**CAUTION**

Data may be lost and/or system errors introduced if the warm-swap is not performed quickly or a power adapter is not installed.

**CAUTION**

The bridge battery can not support an operating notebook. The notebook must be in Suspend mode.

Batteries should be removed and stored separately in a cool dry place if your notebook is not going to be used for an extended period of time.

Under federal, state or local law it may be illegal to dispose of batteries by putting them in the trash. Please take care of our environment and dispose of batteries properly. Check with your local government authority for details regarding recycling or disposing of your old battery, or contact your support representative at 1-800-8FUJITSU (1-800-838-5487).

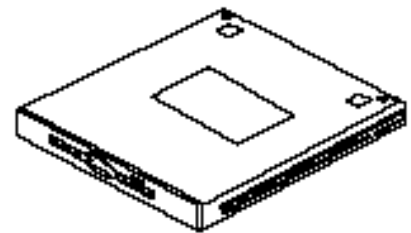


Figure 4-8 Floppy Disk Drive

Floppy Disk Drive

The floppy disk drive can be installed in either Multi-function Bay. In Bay 1 install directly, or in Bay 2 install in the device adapter first. In addition, an optional external floppy disk drive may be purchased to use when both Multi-function bays are needed for other uses. (For information on the care and use of floppy disk drives see Floppy Disk Drive in Section Two on pages 34-36. To install an external floppy disk drive see External Installation of a Floppy Disk Drive on page 107.)

**CAUTION**

The floppy disk drive must be installed or removed with the power off.

PC CARDS

PC Cards perform a wide variety of functions, and are ideal for mobile computers.

Some available PC Cards:

- Fax/data modem cards (Type II).
- Local area network (LAN) cards (Type II).
- Wireless LAN cards (Type II).
- 1MB and 2MB static RAM (SRAM) cards (Type I).
- IDE solid-state disk cards (Type II).
- SCSI cards (Type II).
- Zoomed Video cards (Type II, Slot 0 only).
- ATA cards (Type III).

- Other PC Cards that conform to PCMCIA 2.1 or CardBus standards.

For further information, refer to the instructions supplied with your PC Card.

Caring for PC Cards

PC Cards are durable; however, you must treat them with care. The documentation supplied with your PC Card will provide specific information but you should pay attention to the following points:

- To keep out dust and dirt, store PC Cards in their protective sleeves when they are not installed in your notebook.
- Avoid prolonged exposure to direct sunlight or excessive heat.
- Keep the cards dry.
- Do not flex or bend the cards, and do not place heavy objects on top of them.
- Do not force cards into the slot.
- Avoid dropping cards, or subjecting them to excessive vibration.

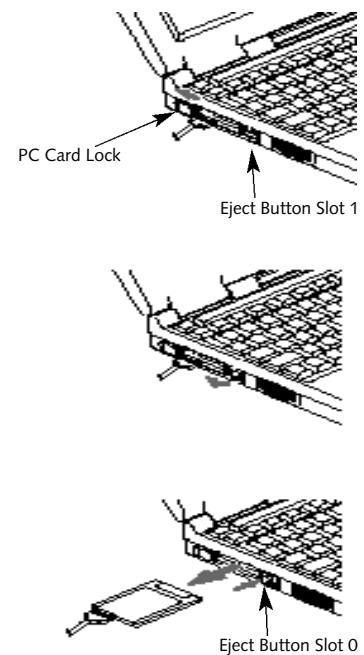


Figure 4-9 Installing and Removing a PC Card

Installing PC Cards in Your Notebook

PC cards are installed in the PC Card slot in the left side panel of your notebook. Some PC Cards will not work when all possible devices are enabled. If a PC Card is not recognized, you will need to open the Control panel, the System folder, and then the Device Manager, and choose a device to disable so that the resources can be used by the PC Card.



CAUTION

Do not insert a PC Card into a slot if there is water or any other substance on the card; you may permanently damage the card, your notebook, or both.

To install a PC Card:

1. See your PC Card manual for instructions on installation of that specific card.

2. Make sure that there is not already a PC Card in the slot. If there is, eject it, as described in Removing PC Cards.

3. Insert the PC Card in the card slot, with the product name label facing up. (Figure 4-9.)



CAUTION

Some PC Cards can only be installed or removed with the power in Suspend mode, some only with power Off. Please check the card documentation for correct usage.



CAUTION

Installing or removing a card while your notebook is in the process of going through the power on or power off sequence may damage the card and/or your notebook.

4. When the PC Card is fully inserted, the eject button will pop out.

5. Flip this button toward the front of your notebook to fold it out of the way.

6. When the card is installed, lock it in place by sliding the Lock button toward the front of your notebook. (Figure 4-9.)



CAUTION

Windows 95 has a shutdown procedure for PC Cards that must be followed before beginning to remove a card.

Removing PC Cards

If you wish to remove or replace the PC Card, use the following procedure:

1. Shutdown operation of the card.

2. Click on the PC Card indicator on the Windows taskbar.

From the PC Card Properties Window:

3. Select the card to be removed and click on the **Stop** button.
4. Verify that the You can safely remove your card message appears.
5. If the device cannot be removed message appears, save all files, close all applications, and exit Windows 95 then shut-off the power with the power switch. (See *Power Off* on pages 24-25.)

**CAUTION**

If the PC Card has an external connector and cable, do not pull on this cable when removing the card.

PARALLEL PORT DEVICES

To connect a parallel interface device to the parallel port, be sure that the connector is the right size and aligned, then push in until it is fully seated. When it is seated tighten the hold-down screws, one on each end of the connector. (See *Figure 1-9* on page 8.)

SERIAL PORT DEVICES

To connect an RS-232C device to the serial port, be sure that the connector is the right size and aligned, then push in until it is fully seated. When it is seated tighten the hold-down screws, one on each end of the connector. (See *Figure 1-9* on page 8.)

USB DEVICES

When installing a device on the USB Port, be sure that the connector is the right size, aligned, and fully seated. (See *Figure 1-8* on page 7.)

**CAUTION**

Due to ongoing changes in USB technology and standards not all USB devices and/or drivers are guaranteed to work.

MICROPHONE

Make sure that your mono microphone is equipped with an 1/8" (3.5 mm) mono mini-plug. Make sure the plug is aligned and push it into the jack until fully seated. (See *Figure 1-8* on page 7.)

STEREO LINE IN DEVICE

Make sure that your stereo line in audio device, a cassette recorder, for example, is equipped with an 1/8" (3.5 mm) stereo mini-plug. Make sure the plug is aligned and push it into the jack until fully seated. (See *Figure 1-8* on page 7.)

HEADPHONES

Make sure that your stereo headphones are equipped with an 1/8" (3.5 mm) stereo mini-plug. Make sure the plug is aligned and push it into the jack until fully seated. (See *Figure 1-8* on page 7.)

**POINT**

Plugging in headphones disables the built-in stereo speakers.

TELEPHONE LINES

To attach a telephone line to the internal modem open the rear panel connector cover or with the cover closed slide the panel in the connector cover slightly opened to reveal the RJ-11 jack. Plug one end of the telephone cable into the telephone line outlet. Orient the telephone cable with the release latch on the connector up. Push it into the jack until it clicks and latches. (See Figure 1-9 on page 8.)



CAUTION

The internal modem is not intended for use with Digital PBX systems. Do not connect the internal modem to a digital PBX as it may cause serious damage to the internal modem or your entire notebook. Consult your PBX manufacturer's documentation for details. Some hotels have Digital PBX systems. Be sure to find out BEFORE you connect your modem.

MOUSE, KEYBOARD OR KEYPAD

Make sure the connector on your device is the correct PS/2 type. Align the arrow on the connector to point to the bottom of your notebook and push it in until the connector seats. A mouse, keyboard or keypad may be installed and automatically recognized by your notebook without restarting or changing setups. (See Figure 1-8 on page 7.)

EXTERNAL MONITOR

You may install an external monitor on the external monitor port on the rear panel of your notebook. Make sure that the wide side of the connector is up and attach it to the port by pushing in until it is seated, then tighten the hold-down screw on each end of the connector. (See Figure 1-9 on page 8.)



CAUTION

Pressing **F10** while holding down the **Fn** key allows you to change your selection of where to send your display video. Each time you press the combination of keys you will step to the next choice. The choices, in order, are: built-in display panel only, external monitor only, or both built-in display panel and external monitor.

THEFT PREVENTION LOCK

A physical security system lock can be installed on the right side of your notebook. (See Figure 1-8 on page 7 for the location of the lock slot.) Simply insert the key end of your security system in the slot, rotate 90 degrees and lock. (See Figure 1-8 on page 7.)

User Installable Features

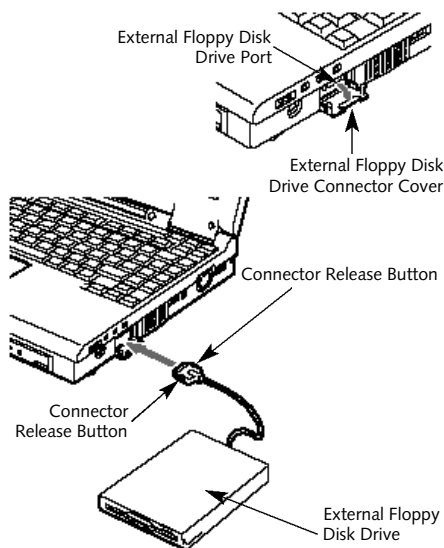


Figure 4-10 External Installation of a Floppy Disk Drive.

EXTERNAL INSTALLATION OF A FLOPPY DISK DRIVE

To install a floppy disk drive externally, you must purchase an optional external floppy disk drive.

To connect a floppy disk drive externally:

1. Close all files and exit all applications.
2. Turn off power to your notebook, close the display and remove the AC adapter. (See pages 24-25 for more information.)
3. Open the external floppy disk drive port cover on the right side panel of your notebook, (see Figure 4-10), by gently pulling on the left side of the cover and then tilting it down.
4. Align the connector of the external floppy disk drive with the connector towards the body of your notebook with the wide side of the connector up. (Figure 4-10)

5. Insert the connector of the external floppy disk drive firmly into the port on your notebook until it clicks.

To disconnect an external floppy disk drive:

1. Close all files and exit all applications
2. Turn off power to your notebook, close the display and remove the AC adapter. (See pages 24-25 for more information.)
3. Squeeze together firmly on the release buttons on either side of the external floppy disk drive connector next to the body of your notebook. (Figure 4-10.)
4. Pull the connector free.
5. Close the floppy disk drive port cover on your notebook by tilting up and pressing until it latches.

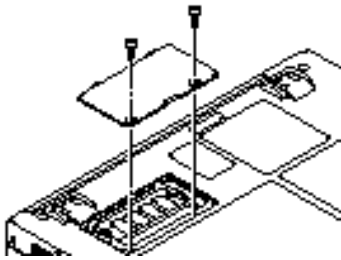


Figure 4-11 Opening the Memory Upgrade Compartment

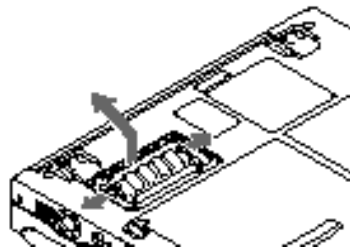


Figure 4-12 Removing a Memory Upgrade Module

MEMORY UPGRADE MODULE

Your notebook has 16MB or 32MB of installed SDRAM. To increase your memory capacity you may install a memory upgrade module in the memory upgrade compartment in the bottom of your notebook. The memory upgrade module is a dual-in-line memory module (DIMM). You may add modules of different capacity. SDRAM modules are recommended but EDO modules will work. Installing an EDO module will cause your system to operate at a slower rate.



CAUTION

Never remove screws except the ones specifically shown in the directions for installing and removing the memory upgrade module.

To Install a Memory Upgrade Module:

1. Turn off power to your notebook using the power switch, (see *Power Off* on pages 24-25), and remove any power adapter (AC or auto/airline).
2. Make sure that all the connector covers are closed.
3. Turn the notebook bottom side up, with the front panel toward you.
4. Remove the screws at the front of the memory upgrade module compartment. (See Figure 4-11)
5. Remove the cover by tilting the front edge up and then pulling forward until the tabs on the cover are free. (See Figure 4-11.)
6. Remove the memory upgrade module from the static guarded sleeve.

User Installable Features



CAUTION

The memory upgrade module can be severely damaged by electro-static discharge (ESD). Be sure you are properly grounded when handling and installing the module.

7. **Align the connector edge of the memory upgrade module with the connector slot in the compartment. The notch on the module should be on the right with the part side up and the connector pointing toward the front of the notebook and aligned with the notch in the connector inside the compartment. (Figure 4-12.)**
8. **Insert the memory upgrade module at a 45° angle. (Figure 4-12.) Press the connector edge of the module firmly down and into the connector.**
9. **Press the memory upgrade module down into the compartment until it lodges under**

the retaining clip. You will hear a click when it is properly in place.

10. **Replace the cover by hooking the tabs under the rear edge of the compartment opening and tilting down until flush with the bottom of your notebook.**

11. **Replace the screws.**

The memory upgrade module is not something you routinely remove from your notebook. Once it is installed, you can leave it in place unless you want to increase system memory capacity.



CAUTION

Before you install or remove the memory upgrade module, save changes and close all files and turn power off to your notebook. (See *Power Off* on pages 24-25.)

To Remove a Memory Upgrade Module:

1. **Perform steps 1 through 5 of To Install a Memory Upgrade Module.**
2. **Pull the clips sideways away from each side of the memory upgrade module at the same time. (Figure 4-12).**
3. **While holding the clips out, remove the module from the slot by lifting it up and pulling towards the rear edge of your notebook. (Figure 4-12).**
4. **Store the memory upgrade module in a static guarded sleeve.**
5. **Replace the cover by following the instructions in steps 10 and 11 of the instructions for To Install a Memory Upgrade Module, or install a new memory upgrade module and then replace the cover by following the instructions in steps 7 through 11 of the instructions To Install a Memory Upgrade Module.**

CAUTION

The memory upgrade module can be severely damaged by electro-static discharge (ESD). Be sure you are properly grounded when handling and removing the module.

3. The System Memory and the Extended Memory capacity, as detected by your notebook during the Power On Self Test (POST), are displayed at the bottom of the Main menu screen.

Example: A system with 32MB of memory will display 640K System Memory, 31M Extended Memory.

Total RAM Installed	System Memory	Extended Memory
16MB	640 K	15M
24MB	640K	23.5M
32MB	640 K	31.7M
48 MB	640 K	48.5M
64 MB	640 K	64M
96 MB	640 K	97M

Checking the Computer Recognition of New Memory Capacity

When you have changed system memory capacity by adding or removing a memory upgrade module, be sure to check that your notebook has recognized all of the memory. You can check memory capacity by looking at the Main menu of the setup utility:

1. Turn on power using the power switch.
2. Enter the setup utility by pressing the F2 key as soon as the Fujitsu logo appears on the screen. (See pages 53-54.)

When you have installed additional memory, the display should change. For example for:

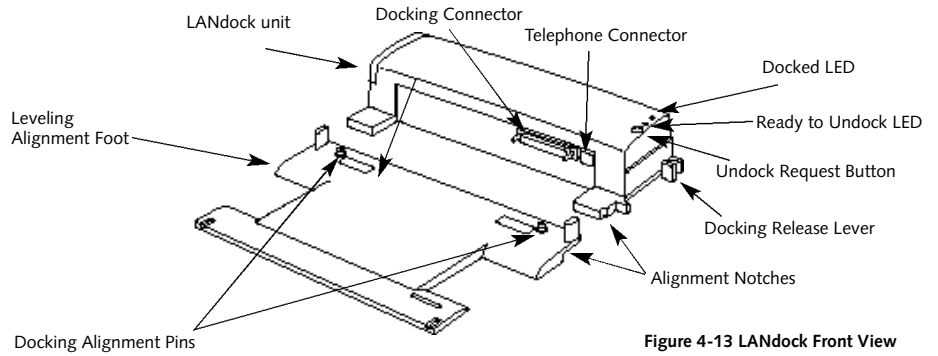


Figure 4-13 LANdock Front View

User Installable Features

If the total memory displayed is not what you believe it should be, check that your memory upgrade module is properly installed. If it is properly installed and the capacity is not correctly recognized, see the Troubleshooting Section starting on page 119.



CAUTION

Follow the instructions that came with your LANDock. These instructions and illustrations in this manual are only to serve as a guideline. The LANDock manual that is included with the LANDock unit supersedes these instructions

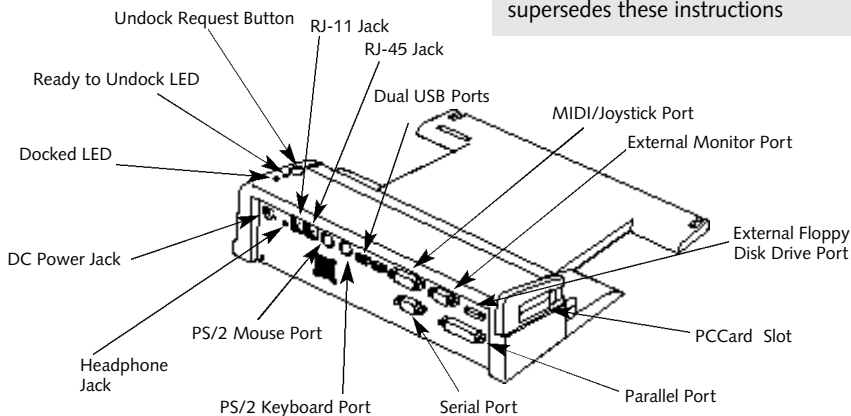


Figure 4-14 LANDock Rear View

LANDOCK

The LANDock is powered from an AC adapter which comes with it.

To Install your Notebook in a docking device:

1. **Put your notebook in Suspend mode or turn off the power.**
2. **To use a docking device with your notebook they both must be on a flat surface.**
3. **Remove all connections from the rear panel of your notebook. (See Figure 1-9 on page 8.)**
4. **Make sure that the adjustment feet are flat against the bottom of the notebook and the covers of the connectors, both rear panel and right side panel, are closed.**
5. **Make sure that the slide cover in the rear panel is completely open.**

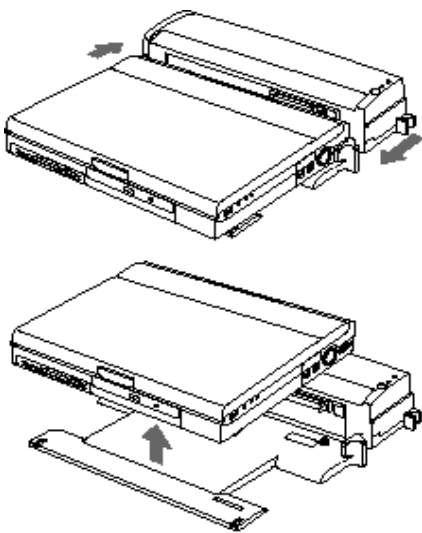


Figure 4-15 Installing a LANdock

6. Set your notebook on the Docking Station Leveler, making sure that the Alignment pins on the leveler (Figures 4-13 and 4-16) fit into the Docking Alignment receptacles in the bottom of your notebook (Figure 1-10 on page 9).
7. Arrange the notebook/leveler combination to align the docking connector on the docking device body with the Docking port on your notebook and the notches on the leveler with the notches on the docking device body.
8. Push together firmly.
9. Lock in place by pulling the Docking Release lever forward.
10. Verify that docking is complete by checking that the LifeBook Docked LED is illuminated. (See Figures 4-13 and 4-16.)
11. Return your notebook to operation using the Suspend/Resume button or power switch, as appropriate. (When setting up for the first time you must use the power switch.)

Connecting Devices to the LANdock or Port Replicator

Connect devices to your LANdock or Port Replicator in exactly the same way you would your notebook. Figure 4-14 shows the location of LANdock ports and jacks. Figure 4-17 shows the location of the Port Replicator ports and jacks. Remember that on the LANdock and the Port Replicator there are separate ports for mouse and keyboard. You must use the correct one.

To Remove Your Notebook from the LANdock or Port Replicator

1. From the Start menu click on Eject PC.
2. Wait for the Safe to Undock LED to illuminate, even if a message appears on your screen saying that you may undock.
3. Push the lever on the side of the station backward until the docking device connectors are completely clear of your notebook.
4. Very carefully lift your notebook clear of the Alignment pins in the bottom.

User Installable Features**POINT**

If the notebook power switch is turned off it is always safe to undock. You do not have to turn on your notebook and use the Eject PC feature.

**CAUTION**

The RJ-11 connector on the rear of your docking device comes with a protective cover to keep the connector clean. Be careful to remove it before trying to make a connection. Save the cover and replace it when the connector is not in use.

Using Your Notebook While It Is Installed In the LANDock

There are a few differences you will notice between using your notebook in and out of the LANDock.

In the LANDock you have added capabilities:

- **In the Windows 95 Start menu there is a PC Eject choice between the Suspend mode and Shutdown selections. (Use the PC Eject choice to enable the undocking of your LifeBook.)**
- **Both an external mouse and an external keyboard can be connected at the same time. Be sure to plug them into the correct PS/2 ports.**
- **There is an additional PC Card slot.**

**CAUTION**

When your notebook is mounted in the LANDock or Port Replicator it is essentially a desktop PC not a mobile notebook. DO NOT unplug the docking device with the operating system active. You may cause a loss of data and a system error when you restart your notebook.

Creating the Windows 95**Docked Configuration**

(This is only necessary when you change notebook configuration and dock your notebook for the first time.)

- 1. Install your notebook in the LANDock or Port Replicator.**
- 2. Turn on the power. The operating system will automatically begin to configure itself for "docked mode" operation.**
- 3. When the configuring is complete the screen will tell you to restart your system.**
- 4. When the restart is complete a little box will appear indicating that you are in the docked configuration but the display will not use the entire screen.**
- 5. To use the entire screen:**
 - a. Go to the Start Menu.**
 - b. Select Settings .**
 - c. Select Control Panel.**

- d. Select the Display icon by double-clicking on it.
- e. Select the <settings> tab and change the resolution to 800 x 600 pixels.
- f. Change the monitor setting to Laptop Display Panel (800 x 600).
- g. Click on the <OK> button to activate the new display settings. Your display should now occupy the entire screen.

Future docking with Windows 95 can be done in Suspend mode, Save-to-Disk mode or with the power off and the system will automatically detect whether you are docked, or not, when you resume operation. Undocking should only be done with power off or in PC Eject mode.

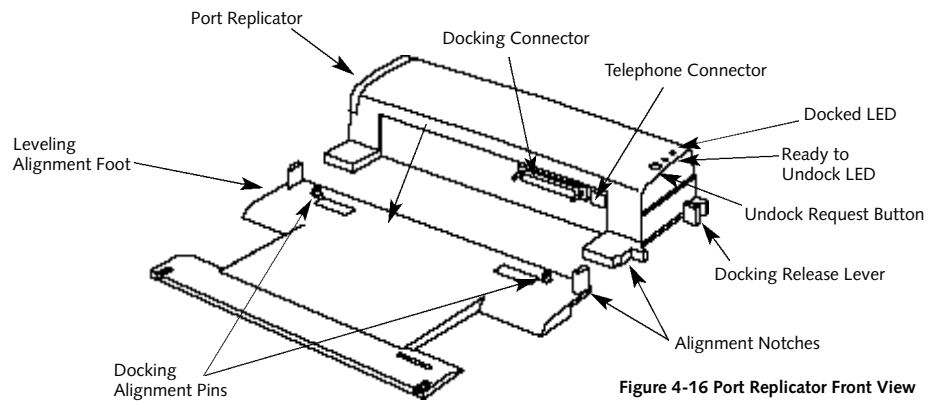


Figure 4-16 Port Replicator Front View

User Installable Features

PORT REPLICATOR

The Port Replicator is installed and operated exactly like the LANdock but adds no additional functions to your notebook. Follow the LANdock instructions for installation and use.

Using Your Notebook While It Is Installed In the Port Replicator

There are a few differences you will notice between using your notebook in and out of the Port Replicator.

- Windows 95 has the addition to the Start Menu of a PC Eject choice between the Suspend mode and Shutdown selections. (Use the PC Eject choice to enable the undocking of your LifeBook.)
- Both an external mouse and an external keyboard can be connected at the same time. Be sure to plug them into the correct PS/2 ports.

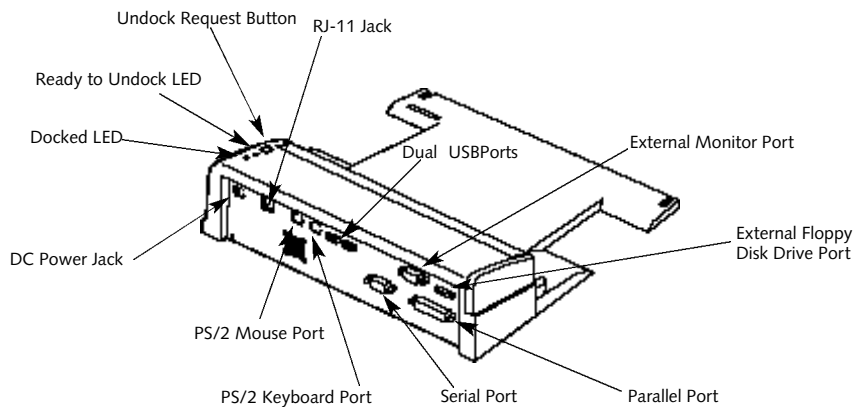


Figure 4-17 Port Replicator Rear View

CAUTION

When your notebook is mounted in the Port Replicator it is essentially a desktop PC not a mobile notebook. DO NOT unplug the Port Replicator with the operating system active. You may cause a loss of data and a system error when you restart your notebook.

T o u b l e s h o o t i n g

Identifying the Problem 118

Specific Problems 119

Power On Self Test Messages 138

Emergency CD-ROM
Tray Release 141

Modem Setup and Commands 141

Restoring Your Pre-installed Software
from CD-ROM. 141

SECTION FIVE TROUBLESHOOTING

The LifeBook 700 Series from Fujitsu is sturdy and subject to few problems in the field. However, you may encounter simple setup or operating problems that you can solve on the spot, or problems with peripheral devices, that you can solve by replacing the device. The information in this section helps you isolate and resolve some of these straightforward problems, and identify failures that require service.

IDENTIFYING THE PROBLEM

If you encounter a problem, go through the following procedure before pursuing complex troubleshooting:

1. Turn off your notebook using the power switch on the right side panel.
2. Make sure the AC adapter is plugged into your notebook and to an active AC power source.
3. Make sure that any card installed in the PC Card slot is seated properly. You can also remove the card from the slot, thus eliminating it as a possible cause of failure.
4. Make sure that any devices connected to the external connectors are plugged in properly. You can also disconnect such devices, thus eliminating them as possible causes of failure.
5. Turn on your notebook using the power switch. Make sure it has been off at least 10 seconds before you turn it on.
6. Go through the boot sequence.
7. If the problem has not been resolved, refer to the problem guide table, which follows, for more detailed troubleshooting information. (Page 119 has an index to the table.)



POINT

If you keep notes about what you have tried, your support representative may be able to help you more quickly by giving additional suggestions over the phone.



CAUTION

Do not return a failed notebook to your supplier until you have talked to a support representative.

8. If you have tried the solutions suggested in Specific Problems without success, contact your support representative: toll free 1-800-8FUJITSU (1-800-838-5487), FAX 1-800-935-1789, e-mail 8fujitsu@fpc.fujitsu.com, Web Site <http://www.8fujitsu.com>.

Before you place the call, you should have the following information ready so that the customer support representative can provide you with the fastest possible solution:

- Product name.
- Product configuration number.
- Product serial number.
- Purchase date.

T r o u b l e s h o o t i n g

- Conditions under which the problem occurred.
- Any error messages that have occurred.
- Hardware configuration.
- Type of printer connected, if any.

See the Configuration Label on the bottom of your notebook for configuration and serial numbers. (Refer to Figure 1-10 on page 9.)

SPECIFIC PROBLEMS

Using PC-Doctor

PC-Doctor is a diagnostic program by Watergate Software, Inc. which comes pre-installed on your notebook. If you are an experienced computer user you may find it useful, however, it is intended primarily to help your Fujitsu support representative better serve you. When you call for help your support representative may ask you to setup your notebook for modem operation. You will be told what to do step by step, and then to hang up the phone and plug your phone line into the back of your notebook. Your support representative will then use the service

computer to call your notebook and perform diagnostic tests to find the nature of your problem. Messages will be displayed on the screen explaining what is being done and giving any instructions that you need.

User Problem Guides

When you have problems with your notebook, try to find the symptoms under the Problem column of the table for the feature giving you difficulty. You will find a description of common causes for that symptom under the column Possible Cause and what, if anything you can do to correct the condition under Possible Solution.

Remember that it helps to keep notes of what you have tried and the results when you are troubleshooting.

Problem	Page
Audio Problems	120
CD-ROM Drive Problems	120
Docking Problems	121
Floppy Disk Drive Problems	122
Hard Drive Problems	123
Keyboard or Mouse Problems	123
Memory Problems	124
Modem Problems	125
Parallel, Serial, and USB Device Problems ..	125
PC Card Problems	126
Power Failure	127
Shutdown and Startup Problems	132
Video Problems	134
Miscellaneous Problems	137

Problem

Possible Cause

Possible Solution

Audio Problems

There is no sound coming from the built-in speakers.

1. **The volume knob is turned too low.**
2. **The software volume control is set too low.**
3. **Headphones are plugged into your notebook.**
4. **BIOS audio settings are incorrect.**
5. **Software driver is not configured correctly.**

1. **Adjust the volume control knob on the right side of your notebook.**
2. **Adjust the sound volume control settings in your software, both operating system and applications.**
3. **Plugging in headphones disables the built-in speakers, remove the headphones.**
4. **Set the BIOS setup utility, Audio Features submenu of the Advanced menu to the default values. (See pages 73-74.)**
5. **Refer to your application and operating system documentation for help.**

CD-ROM Drive Problems

Notebook fails to recognize CD-ROM.

1. **Shipping card is still in the CD-ROM drive tray.**
2. **CD-ROM is installed with label face down.**
3. **CD-ROM is not pushed down onto raised center circle of drive.**
4. **CD-ROM tray is not latched shut.**

1. **Remove shipping card and replace CD in tray.**
2. **Open CD-ROM tray and re-install CD with proper orientation.**
3. **Open CD-ROM tray and re-install CD properly.**
4. **Push on the front of the CD-ROM tray until it latches.**

T r o u b l e s h o o t i n g

Problem	Possible Cause	Possible Solution
<p>The CD-ROM Access indicator on the Status Indicator panel blinks at regular intervals when no CD is in the tray or the CD-ROM drive is not installed.</p>	<ul style="list-style-type: none"> 5. Setup utility is set to something other than CD-ROM for the Secondary Master Controller. 6. Wrong drive designator was used for CD-ROM in the application 7. Windows CD auto insertion function is disabled. 	<ul style="list-style-type: none"> 5. Revise BIOS settings to set IDE Adapter 1 Master correctly. (See Main menu and IDE Adapter submenu pages 56-62 for more information.) 6. Verify the drive designator used by the application is the same as the one used by the operating system. When the operating system is booted from a CD-ROM drive designations are automatically adjusted. (See Boot Options submenu on pages 63-64.) 7. Start the CD from the desktop or application software or re-enable the Windows CD auto insertion function. (See CD-ROM Access Indicator on pages 21-22 for more information.)
<p>Docking Problems</p> <p>Notebook does not turn on when installed in Docking Station.</p>	<ul style="list-style-type: none"> 1. The Windows CD auto insertion function is active and is checking to see if a CD is ready to run. 1. LANdock AC adapter is not plugged in. 	<ul style="list-style-type: none"> 1. This is normal. You can disable this function if you wish. (See CD-ROM Access Indicator on pages 21-22 for more information.) 1. Provide power to the LAN-Docking Station.

Problem	Possible Cause	Possible Solution
Floppy Disk Drive You cannot access your floppy disk.	<ol style="list-style-type: none"> 1. Security is set to protect access to floppy disk data. 2. Floppy disk is not loaded correctly. 3. BIOS setup utility has Diskette Controller: Disabled 4. The floppy disk drive may not be properly installed. 5. You tried to write to a write protected floppy disk. 	<ol style="list-style-type: none"> 1. Verify your password and security settings. 2. Eject floppy disk, check orientation and re-insert. (See <i>Floppy Disk Drive</i> on pages 34-35.) 3. Revise the setup utility Main menu settings. (See <i>Main Menu</i> on pages 56-57.) 4. Remove and re-install your floppy disk drive. (See <i>Multi-function Bays</i> on pages 97-100, or <i>External Installation of a Floppy Disk Drive</i> on page 107.) 5. Eject the floppy disk and set it to write enabled. (See page 35.)

T r o u b l e s h o o t i n g

Problem	Possible Cause	Possible Solution
Hard Drive Problems You can not access your hard drive.	<ol style="list-style-type: none"> 1. The setup utility is set to something other than the characteristics of your internal or optional second hard drive. 2. The wrong drive designator was used by an application when a bootable CD-ROM was used to start the notebook. 3. Security is set so operating system can not be started without a password. 	<ol style="list-style-type: none"> 1. Revise BIOS settings to set both IDE Adapter 0 Master and IDE Adapter 1 Master correctly. (See MainMenu and IDE Adapter Submenu pages 56-62 for more information.) (Internal is Master 0 and optional second is Master 1.) 2. Verify drive designator used by application is in use by the operating system. When the operating system is booted from a CD-ROM, drive designations are automatically adjusted. (See IDE Adapter Submenu on pages 59-62.) 3. Verify your password and security settings. (See Security menu on pages 77-80.)
Keyboard or Mouse Problems The built-in keyboard does not seem to work.	<ol style="list-style-type: none"> 1. The notebook has gone into Suspend mode. 2. Your application has locked out your keyboard. 	<ol style="list-style-type: none"> 1. Push the Suspend/Resume button. 2. Try to use the ErgoTrac pointing device to access the Start menu and then the ShutDown menu and restart the System. If this fails then turn your notebook off, wait 10 seconds or more, and then turn it on using the power switch.

Problem	Possible Cause	Possible Solution
You have installed an external keyboard	<ol style="list-style-type: none"> 1. Your external device is not properly installed. 2. Your operating system software is not setup with the correct software driver for that device. 3. Your mouse or keyboard is connected to the wrong PS/2 port on the LANdock. 	<ol style="list-style-type: none"> 1. Re-install your device. (See <i>Mouse or Keyboard on page 106.</i>) or mouse, and it does not seem to work. 2. Check your device and operating system documentation and activate the proper driver. 3. Plug the mouse into the PS/2 Mouse port and the external keyboard or numeric key pad into the PS/2 Keyboard port. (Figure 4-14 on page 111 and Figure 4-17 on page 115.)
You have connected an external keyboard or a mouse and it seems to be locking up the system.	<ol style="list-style-type: none"> 1. Your operating system software is not setup with the correct software driver for that device. 2. Your system has crashed. 	<ol style="list-style-type: none"> 1. Check your device and operating system documentation and activate the proper driver. 2. Restart your system by shutting down and/or turning off the power, waiting at least 10 seconds and then turning the power on again.
Memory Problems		
Your power on screen or Main menu of the BIOS setup utility information does not show the correct amount of installed memory.	<ol style="list-style-type: none"> 1. Your memory upgrade module is not properly installed. 	<ol style="list-style-type: none"> 1. Remove and re-install your memory upgrade module. (See <i>Memory Upgrade Module on pages 108-110.</i>)

T r o u b l e s h o o t i n g

Problem	Possible Cause	Possible Solution
	<ol style="list-style-type: none"> 2. You have a memory failure. 	<ol style="list-style-type: none"> 2. Make sure display of error messages is enabled (see <i>Boot Options Submenu</i> on pages 56-57), and check for Power On Self Test (POST) messages. (See pages 138-140 for possible messages and their meanings.)
<p>Modem Problems</p> <p>Messages about modem operation.</p>	<ol style="list-style-type: none"> 1. Messages about modem operation are generated by whichever modem application is in use. 	<ol style="list-style-type: none"> 1. See your application software documentation for additional information.
<p>Parallel, Serial, and USB Device Problems</p> <p>You have installed a parallel-port device, a serial-port device or a USB device. Your notebook does not recognize the device, or the device does not seem to work properly.</p>	<ol style="list-style-type: none"> 1. The device is not properly installed. 2. The device may have been installed with an application running and your notebook doesn't know it's there. 3. Your software may not have the correct software driver active. 	<ol style="list-style-type: none"> 1. Remove and re-install the device. (See <i>Parallel Port Devices</i> on page 105, <i>Serial Port on Devices</i> on page 105, or <i>USB Devices</i> on page 105.) 2. Close your application and restart your notebook. 3. See your software documentation and activate the correct driver.

Problem

 **CAUTION**

Due to ongoing changes in USB technology and standards, not all USB devices and/or drivers are guaranteed to work.

Possible Cause

4. You may have the wrong I/O address selected for your device.
5. Your device and another device are assigned the same I/O address.

Possible Solution

4. See your device documentation and software documentation to determine the required I/O address.
5. Check all I/O addresses in the BIOS Setup Utility and your other installed hardware and software and make sure there are no duplications.

PC Card Problems

A card inserted in the PC Card slot does not work or is locking up the system.

1. The card is not properly installed.
2. The card may have been installed with an application running and your notebook doesn't know it's there.
3. Your software may not have the correct software driver active.
4. You may have the wrong I/O address selected for your PC Card device.
5. Your PC Card device and another device are assigned the same I/O address.

1. Remove and re-install the card. (See *PC Cards* on pages 103-105.)
2. Close your application and restart your notebook.
3. See your software documentation and activate the correct driver.
4. See your PC Card documentation to determine the required I/O address.
5. Check all I/O addresses in the BIOS setup utility and your other installed hardware and make sure there are no duplications.

T r o u b l e s h o o t i n g

Problem	Possible Cause	Possible Solution
<p>Power Failures</p> <p>You turn on your notebook and nothing seems to happen.</p>	<ol style="list-style-type: none"> 1. The installed primary battery is completely discharged, there is no optional second battery installed and there is no Power adapter (AC or auto/airline) installed. 2. The primary battery is installed but is completely discharged, there is no optional second battery installed and the Power adapter (AC or auto/airline) is not plugged in properly. 	<ol style="list-style-type: none"> 1. When all the batteries are dead there will be a beep when the power switch is turned on and the notebook will immediately go into Dead Battery Suspend mode. (See page 29). Check the Status Indicator panel to determine the presence and condition of the batteries. (See pages 20-21.) Install the primary battery if it is not installed or a Power adapter if all batteries are dead or unavailable. (See pages 97-100 and 10-11.) 2. When the batteries are dead there will be a beep when the power switch is turned on and the notebook will immediately go into Dead Battery Suspend mode. (See page 29) Check the Status Indicator panel to determine the presence and condition of the batteries and adapter. (See Figures 2-3 and 2-4 on pages 20-21.) Verify that your adapter is connected correctly. (See pages 10-11.)

Problem

Possible Cause

3. **The primary battery is installed but is completely discharged, there is no optional second battery installed and the Power adapter (AC or auto/airline) has no power from the AC outlet, airplane seat jack, or the car's**

4. **The primary battery is installed but is completely discharged, there is no optional second battery installed and the Power adapter (AC or auto/airline) is faulty.**

Possible Solution

3. **When the battery is dead there will be a beep when the power switch is turned on and the notebook will immediately go into Dead Battery Suspend mode. (See page 29.) Check the Status Indicator cigarette lighter panel to determine the presence and condition of the batteries and adapter. (See Figures 2-3 and 2-4 on pages 20-21.) Move the AC cord to a different outlet, check for a line switch or tripped circuit breaker for the AC outlet, if you are using an auto/airline adapter in a car make sure the ignition switch is in the On or Accessories position.**
4. **When the battery is dead there will be a beep when the power switch is turned on and the notebook will immediately go into Dead Battery Suspend mode. (See page 29.) Verify the cause using the Status Indicator panel to determine the presence and condition of the batteries and adapter. (See Figures 2-3 and 2-4 on pages 20-21.) Try a different Power adapter or install a charged optional second battery.**

T r o u b l e s h o o t i n g

Problem

Possible Cause

5. **Power switch is already in the On position.**

6. **There is no battery installed and there is no Power adapter (AC or auto/airline) installed.**

7. **The primary battery is installed but is faulty, there is no optional second battery installed and there is no Power adapter (AC or auto/airline) installed.**

Possible Solution

5. **Try the Suspend/Resume button. If that doesn't work, slide your power switch firmly to the front, pause 10 seconds or more and then firmly to the rear. If you shut down your notebook from Windows 95, you are really in a pseudo-off state, there is some power on and you can restart with the Suspend/Resume button.**
(See *Power Off* on pages 24-25.)
6. **Use the Status Indicator panel to verify the presence and condition of the batteries.** (See *Figure 2-3* on page 20.) **Install a Power adapter or install a battery in one of the Multi-function bays in the front of your notebook.** (See *Multi-function Bay Devices* on pages 97-100.) **If the battery is not charged use a Power adapter until it is charged.**
7. **Use the Status Indicator panel to verify the presence and condition of the batteries.** (See *Figure 2-3* on page 20.) **If a battery is indicating a short, remove that battery and operate from another power source or replace that battery.**

Problem	Possible Cause	Possible Solution
Your notebook turns off all by itself.	<p data-bbox="566 793 886 814">8. The battery or batteries are low.</p> <p data-bbox="566 1056 992 1136">1. The power management parameters are set for auto timeouts which are too short for your operating needs.</p> <p data-bbox="566 1297 1049 1402">2. You are operating on battery only and have ignored a low battery alarm until the batteries are all at the dead battery state and your machine has gone into Dead Battery Suspend mode.</p>	<p data-bbox="1049 793 1484 1035">8. If the batteries are dead there will be a beep when the power switch is turned on and the notebook will immediately go into Dead Battery Suspend mode. (See page 29.) Check the Status Indicator panel to determine the presence and condition of the batteries. (See Figure 2-3 on page 20.) Use a Power adapter to operate until a battery is charged or install a charged battery.</p> <p data-bbox="1049 1056 1484 1297">1. Use the keyboard or pointer and if that does not restore operation, push the Suspend/Resume button. Check the PowerPanel settings or close your applications and go to the setup utility Power Savings menu and adjust the timeout values to better suit your operation needs. (See the PowerPanel on pages 40-43 and Power Savings Menu on pages 81-87.)</p> <p data-bbox="1049 1297 1484 1377">2. Install a Power adapter and then push the Suspend/Resume button. (See Low Battery State on page 29.)</p>

T r o u b l e s h o o t i n g

Problem	Possible Cause	Possible Solution
Your notebook won't work on battery alone.	<ul style="list-style-type: none"> 3. You have a battery failure. 4. Your Power adapter has failed or lost its power source. 	<ul style="list-style-type: none"> 3. Verify the condition of the batteries using the Status Indicator panel (Figure 2-3 on page 20), and replace or remove any that are shorted. 4. Make sure the adapter is plugged in and the outlet has power.
	<ul style="list-style-type: none"> 1. The installed batteries are dead. 2. No batteries are installed. 3. The batteries are improperly installed. 4. Your installed batteries are faulty. 	<ul style="list-style-type: none"> 1. When the batteries are dead there will be a beep when the power switch is turned on and the notebook will immediately go into Dead Battery Suspend mode. (See page 29) Replace the battery with a charged one or install a Power adapter. 2. Install a charged battery. (See Multi-function Bay Devices on pages 97-100.) 3. Verify that the batteries are properly connected by re-installing them. (See Multi-function Bay Devices on pages 97-100.) 4. Verify the condition of the batteries using the Status Indicator panel, (Figure 2-3 on page 20.), and replace or remove any that are shorted.

Problem

The batteries seem to discharge too quickly.

Possible Cause

1. **You are running an application which uses a great deal of power because of frequent hard drive access or CD-ROM access, use of a modem PC Card or of a LAN PC Card.**
2. **The power savings features may be disabled.**

3. **The brightness is turned all the way up.**

4. **The batteries are very old.**
5. **The batteries have been exposed to high temperatures.**
6. **The batteries are too hot or too cold.**
(See *Batteries on page 26.*)

Possible Solution

1. **Use both the primary battery and an optional second battery and/or use a Power adapter for this application when at all possible.**
2. **Check the PowerPanel and/or setup utility settings in the Power Savings menu (see pages 40-43 and 81-87), and adjust according to your operating needs.**
3. **Turn down the brightness adjustment. The higher the brightness the more power your display uses.**
4. **Replace the batteries.**
5. **Replace the batteries.**

6. **Restore the notebook to normal operating temperature. (The Charging icon on the Status Indicator panel will flash when the battery is outside its operating range.)**

Shutdown and Startup Problems

The Suspend/Resume button does not work.

1. **The Suspend/Resume button is disabled from the Advanced submenu of the Power Savings menu of the setup utility.**

1. **Enable the button from the setup utility.**
(See *page 87.*)

T r o u b l e s h o o t i n g

Problem

The system powers up, and displays power on information, but fails to load the operating system.

Possible Cause

2. **You did not hold the button in long enough.**
3. **There may be a conflict with the application software.**
1. **The boot sequence settings of the setup utility are not compatible with your configuration.**
2. **You have a secured system requiring a password to load your operating system.**
3. **Internal hard drive was not detected.**

Possible Solution

2. **Hold the button longer. This may need to be a very long time if your application is preventing the CPU from checking for button pushes.**
3. **Close all applications, and try the button again.**
1. **Set the operating source by pressing the Esc key while the Fujitsu logo is on screen or use the F2 key and enter the setup utility and adjust the source settings from the Boot menu on page 89.**
2. **Make sure you have the right password. Enter the setup utility and verify the Security settings and modify them as appropriate. (See Security Menu on pages 77-80.)**
3. **Use the BIOS setup utility Main menu, IDE Adapter submenu to try to auto detect the internal hard drive.**

Problem

An error message is displayed on the screen during the notebook turn on (boot) sequence.

Possible Cause

1. Power On Self Test (POST) has detected a problem.

Possible Solution

1. See the Power On Self Test (POST) Messages (pages 138-140) to determine the meaning and severity of the problem. Not all messages are errors; some are simply status indicators.

Your notebook appears to change setup parameters when you start it.

**1. BIOS setup changes were not saved when you made them and exited the BIOS setup utility returning it to previous settings.
2. The BIOS CMOS hold-up battery has failed.**

**1. Make sure you select Save Changes And Exit when exiting the BIOS setup utility.
2. Contact your support representative for repairs. This is not a user serviceable part but has a normal life of 3 to 5 years.**

Video Problems

The built-in display is blank when you turn on your notebook.

**1. Something is pushing on the Closed Cover switch. (See Figure 1-7 on page 7.)
2. The notebook is set for an external monitor only.**

**1. Clear the Closed Cover switch.
2. Pressing F10 while holding down the Fn key allows you to change your selection of where to send your display video. Each time you press the combination of keys you will step to the next choice. The choices, in order, are built-in display only, external monitor only, both built-in display and external monitor.**

T r o u b l e s h o o t i n g

Problem

The display goes blank by itself after you have been using it.

Possible Cause

3. **The angle of the display and the brightness settings are not adequate for your lighting conditions.**
 4. **The power management timeouts may be set for very short intervals and you failed to notice the display come on and go off again.**
 5. **The notebook turned on with a series of beeps.**
1. **The notebook has gone into Video timeout, Standby mode, Suspend mode or Save-to-Disk mode because you have not used it for a period of time.**
 2. **Something is pushing on the Closed Cover switch. (See Figure 1-7 on page 7.)**

Possible Solution

3. **Move the display and the brightness control until you have adequate visibility.**
 4. **Press any key or move the pointer, if this doesn't work press the Suspend/Resume button. (The display may be shut off by Standby mode, Auto Suspend, or Video Timeout.)**
 5. **Power On Self Test (POST) has detected a failure which does not allow the display to operate. Contact your support representative.**
1. **Use the keyboard or pointer and if that does not restore operation, push the Suspend/Resume button. You may want to change your PowerPanel settings (pages 40-43) or close your application and go to the setup utility Power Savings menu (pages 81-87) and adjust the timeout values to better suit your operation needs.**
 2. **Clear the Closed Cover switch.**

Problem	Possible Cause	Possible Solution
The Built-in Display does not close.	<ol style="list-style-type: none"> <li data-bbox="566 789 1024 869">3. The power management timeouts may be set for very short intervals and you failed to notice the display come on and go off again. 	<ol style="list-style-type: none"> <li data-bbox="1049 789 1390 869">3. Press any key or move the pointer, if this doesn't work press the Suspend/Resume button.
The Built-in Display has bright or dark spots.	<ol style="list-style-type: none"> <li data-bbox="566 890 1008 940">1. A foreign object, such as a paper clip, is stuck between the display and the keyboard. <li data-bbox="566 961 1008 1012">1. If the spots are very tiny and few in number, this is normal for a large LCD display. <li data-bbox="566 1016 1008 1066">2. If the spots are numerous or large enough to interfere with your operation needs. 	<ol style="list-style-type: none"> <li data-bbox="1049 890 1370 940">1. Remove all foreign objects from the keyboard. <li data-bbox="1049 961 1370 991">1. This is normal; do nothing. <li data-bbox="1049 1016 1370 1066">2. Display is faulty; contact your support representative.
The application display uses only a portion of your screen and is surrounded by a dark band.	<ol style="list-style-type: none"> <li data-bbox="566 1117 1008 1192">1. You are running an application that does not support 800 x 600 pixel resolution display and display compression is enabled. 	<ol style="list-style-type: none"> <li data-bbox="1049 1117 1471 1308">1. Display compression gives a clearer but smaller display for applications that do not support 800 x 600 pixel resolution. You can fill the screen but have less resolution by changing your display compression setting. (See Video Features Submenu of the Advanced Menu on pages 75-76.)

T r o u b l e s h o o t i n g

Problem

You have connected an external monitor and it does not come on.

Possible Cause

1. **Your BIOS setup is not set to enable your external monitor.**
2. **Your external monitor is not properly installed.**
3. **Your operating system software is not setup with the correct software driver for that device.**
4. **Your external monitor is not compatible with your notebook.**

Possible Solution

1. **Try toggling the video destination by pressing Fn and F10 together or check your BIOS setup and enable your external monitor.** (See the *Video Features Submenu of the Advanced Menu* on pages 75-76.)
2. **Reinstall your device.** (See *External Monitor* on page 106.)
3. **Check your device and operating system documentation and activate the proper driver.**
4. **See your monitor documentation and the External Monitor Support portions of Appendix A on pages 148-157.**

Miscellaneous Problems

An error message is displayed on the screen during the operation of an application.

1. **Application software often has its own set of error message displays.**

1. **See your application manual and help displays screens for more information. Not all messages are errors; some may simply be status.**

POWER ON SELF TEST MESSAGES

The following is an alphabetic list of error-and-status messages that Phoenix BIOS and/or your operating system can generate and an explanation of each message. Error messages are marked with an *. Comments in italics are suggestions of possible actions for you to consider, or risks resulting from ignoring the message. The most common errors are marked with a #. If an error message is displayed that is not in this list, write it down and check your operating system documentation both on screen and in the manual. If you can find no reference to the message and its meaning is not clear, contact your support representative for assistance.

nnnn Cache SRAM Passed Where **nnnn** is the amount of system cache in kilobytes successfully tested by the Power On Self Test. (This can only appear if you have an SRAM PC Card installed.)

*Diskette drive A error or Diskette drive B error **Drive A: or B:** is present but fails the BIOS Power On Self Test diskette tests. Check to

see that the drive is defined with the proper diskette type in the Utility Setup, (see page 57) and that the diskette drive is installed correctly, (see pages 97-100 and 107). If the disk drive is properly defined and installed, avoid using it and contact your support representative.

*Extended RAM Failed at offset:nnnn Extended memory not working or not configured properly. If you have an installed memory upgrade module, verify that the module is properly installed. If it is properly installed, you may want to check your Windows Setup to be sure it is not using unavailable memory until you can contact your support representative.

nnnn Extended RAM Passed Where **nnnn** is the amount of memory in kilobytes successfully tested.

*Failing Bits:nnnn The hex number **nnnn** is a map of the bits at the memory address (in System, Extended, or Shadow memory) which failed the memory test. Each 1 (one) in the map indicates a failed bit. This is a serious fault that

might cause you to lose data if you continue. Contact your support representative.

*Fixed Disk x Failure or Fixed Disk Controller Failure (where x = 1-4) **Fixed disk is not working or not configured properly.** This may mean that the hard drive type identified in your Setup Utility does not agree with the type detected by the Power On Self Test. Run the Setup Utility to check for the hard drive type settings and correct them if necessary. If the settings are OK and the message appears when you restart the system, there may be a serious fault which might cause you to lose data if you continue. Contact your support representative.

*Incorrect Drive A type – run SETUP **Type of floppy drive A: not correctly identified in Setup.** This means that the floppy disk drive type identified in your Setup Utility does not agree with the type detected by the Power On Self Test. Run the Setup Utility to correct the inconsistency.

*Incorrect Drive B type – run SETUP **Type of floppy drive B: not correctly identified in Setup.**

T r o u b l e s h o o t i n g

This means that the floppy disk drive type identified in your Setup Utility does not agree with the type detected by the Power On Self Test. Run the Setup Utility to correct the inconsistency.

***Invalid NVRAM media type Problem with NVRAM access. In the unlikely case that you see this message you may have some display problems. You can continue operating but should contact your support representative for more information.**

***Keyboard controller error The keyboard controller test failed. You may have to replace your keyboard or keyboard controller but may be able to use an external keyboard until then. Contact your support representative.**

***Keyboard error Keyboard not working. You may have to replace your keyboard or keyboard controller but may be able to use an external keyboard until then. Contact your support representative.**

***Keyboard error nn BIOS discovered a stuck key and displays the scan code for the stuck key.**

You may have to replace your keyboard but may be able to use an external keyboard until then. Contact your support representative.

***Monitor type does not match CMOS – Run SETUP Monitor type not correctly identified in Setup. This error probably means your BIOS is corrupted, run the Setup Utility and set all settings to the default conditions. If you still get this error, contact your support representative.**

#*Operating system not found Operating system cannot be located on either drive A: or drive C: Enter the Setup Utility and see if fixed disk and drive A: are properly identified and that the boot sequence is set correctly. Unless you have changed your installation greatly, the operating system should be on drive C:. If the setup utility is correctly set your hard drive is probably corrupted and your system may have to be re-installed from your back up media.

***Parity Check 1 nnnn Parity error found in the system bus. BIOS attempts to locate the address and display it on the screen. If it cannot locate**

the address, it displays ?????. This is a potentially data destroying failure. Contact your support representative.

***Parity Check 2 nnnn Parity error found in the I/O bus. BIOS attempts to locate the address and display it on the screen. If it cannot locate the address, it displays ?????. This is a potentially data destroying failure. Contact your support representative.**

#*Press <F1> to resume, <F2> to SETUP is displayed after any recoverable error message. Press the F1 key to continue the boot process or the F2 key to enter Setup and change any settings.

#Press <F2> to enter SETUP message is displayed during Power On Self Test. The message can be turned off by the setup utility Boot Options Submenu, (see pages 63-64), but the F2 key will still perform the same function.

#*Previous boot incomplete – Default configuration used Previous Power On Self Test did not complete successfully. Power On Self Test

loads default values and offers to run Setup. If the failure was caused by incorrect values and they are not corrected, the next boot will likely fail also. If using the default settings does not allow you to complete a successful boot sequence, you should turn off the power with the Power Switch and contact your support representative.

*Real time clock error **Real-time clock fails BIOS test. May require board repair. Contact your support representative.**

*Shadow RAM Failed at offset:nnnn **Shadow RAM failed at offset nnnn of the 64k block at which the error was detected. You are risking data corruption if you continue. Contact your support representative.**

nnnn Shadow RAM Passed **Where nnnn is the amount of shadow RAM in kilobytes successfully tested.**

*System battery is dead – Replace and run SETUP **The BIOS CMOS RAM memory hold up battery is dead. This is part of your BIOS**

and is a board mounted battery which requires a support representative to change. You can continue operating but you will have to use Setup Utility default values or reconfigure your Setup Utility every time you turn off your notebook. This battery has an expected life of 2 to 3 years.

System BIOS shadowed **System BIOS copied to shadow RAM.**

*System CMOS checksum bad – run SETUP **BIOS CMOS RAM has been corrupted or modified incorrectly, perhaps by an application program that changes data stored in BIOS memory. Run Setup and reconfigure the system.**

*System RAM Failed at offset:nnnn **System memory failed at offset nnnn of in the 64k block at which the error was detected. This means that there is a fault in your built-in memory. If you continue to operate you risk corrupting your data. Contact your support representative for repairs.**

nnnn System RAM Passed **Where nnnn is the amount of system memory in kilobytes successfully tested.**

*System timer error **The timer test failed. The main clock that operates the computer is faulty. Requires repair of system board. Contact your support representative for repairs.**

UMB upper limit segment address:nnnn **Displays the address of the upper limit of Upper Memory Blocks, indicating released segments of the BIOS memory which may be reclaimed by a virtual memory manager.**

Video BIOS shadowed **Video BIOS successfully copied to shadow RAM.**

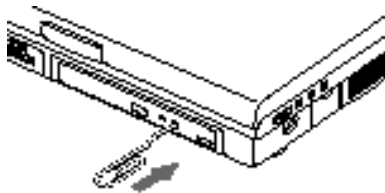


Figure 5-1 Emergency CD-ROM Tray Release

EMERGENCY CD-ROM TRAY RELEASE

If for some reason the eject button fails, you can open the CD-ROM tray with a paper clip or similar tool inserted into the eject hole in the far right side of the front of the tray. Straighten one side of a paper clip and push it gently into the hole. The tray will pop out a short distance.

MODEM SETUP AND COMMANDS

The operating system and application software that is factory installed detects the modem characteristics and provides the necessary command strings to operate the modem. The internal modem operation is controlled by generic AT commands from the operating system and application software. The standard long form result codes may, in some cases, be displayed on your screen to keep you informed of the actions of your modem. The operating system and application software may suppress display of the result codes.

Examples of result codes are:

OK
 NO CARRIER
 NO DIALTONE
 CONNECT 56000
 (Connection complete at 56,000 bps.)
 ERROR
 FAX
 RING (This means an incoming call.)
 BUSY
 NO ANSWER

When using the internal modem with applications which are not factory installed see the application documentation.

RESTORING YOUR PRE-INSTALLED SOFTWARE FROM CD-ROM

To restore your pre-installed software from the Recovery CD-ROM follow the instructions with the CD-ROM.

Remember that you must set the Boot menu in the BIOS setup utility to CD-ROM Drive, or use the Esc key during boot-up sequence to change the setting. The BIOS loads the CD-ROM, not the hard disk. (See page 89 for ways to set the operating system source.)

**CAUTION**

User data and user installed applications can not be recovered from the Recovery CD-ROM.

Care and Maintenance

Care and Maintenance 144

Caring for Your Notebook. 144

Increasing Battery Life 145

Caring for Your Batteries 145

SECTION SIX

CARE AND MAINTENANCE

If you use your LifeBook 700 Series from Fujitsu carefully, you will increase its life and reliability. This section provides some tips for looking after the notebook and the battery packs.

CARING FOR YOUR NOTEBOOK

- The LifeBook 700 Series is a durable but sensitive electronic device. Treat it with respect and care.
- Make a habit of transporting it in a suitable carrying case.
- Keep it away from food and beverages.
- If you accidentally spill liquid on your notebook:
 1. Turn it off.
 2. Position it so that the liquid can run out.
 3. Let it dry out for 24 hours, or longer if needed.
 4. If your notebook will not boot after it has dried out, call your support representative.
- Avoid exposure to water, sand, dust, and other environmental hazards.
- Do not expose your notebook to direct sunlight for long periods of time as temperatures above 140° F (60° C) may damage your notebook.
- Keep the covers closed on the connectors and slots when they are not in use.
- Do not put heavy or sharp objects on the computer.
- If you are carrying your notebook in a briefcase, or any other carrying case, make sure that there are no objects in the case pressing on the lid of your notebook.
- Do not drop your notebook.
- Clean your notebook with a damp, lint-free cloth. Do not use abrasives or solvents.
- Use a soft cloth to remove dust from the screen.

INCREASING BATTERY LIFE

To increase battery life:

1. Power your notebook through the AC or optional auto/airline adapter whenever possible.
2. If your notebook is running on battery power all day, connect it to the AC adapter overnight to recharge the battery.
3. Keep brightness to the lowest level comfortable.
4. Set the power management for maximum battery life.
5. Put your notebook in Suspend mode when it is turned on and you are not actually using it.
6. Limit your CD-ROM access.
7. Disable the Windows 95 CD automatic insertion function. (See page 20)
8. Always use fully charged batteries.

CARING FOR YOUR BATTERIES

If your notebook is to be stored for a month or longer, turn the machine off and remove all Lithium ion batteries. Store your notebook and batteries separately in a cool, dry location. If you store your notebook with a battery installed, the battery will discharge, and battery life will be reduced. In addition, a faulty battery might damage your notebook.

Specifications and Glossary

Appendix A Specifications 148
Warranty 148
LifeBook 735DX Specifications 148
LifeBook 755TX Specifications 151
LifeBook 765TX Specifications 154
Approvals 157
Popular Accessories 157
Appendix B Glossary 159

Appendix A Specifications

Appendix A provides the hardware and environmental specifications and the model and part numbers for your LifeBook™ 700 Series and its peripherals.

Warranty

Your notebook is backed by a limited warranty and includes toll-free technical support; call 1-800-8FUJITSU (1-800-838-5487.) Check the service kit that came with your notebook for warranty terms and conditions.

Lifebook 735Dx Specifications

Microprocessor

Intel Pentium P55CSLM 133MHz with MMX technology, L1 and L2 cache, PCI bus architecture, and CardBus architecture.

Memory

System Memory
16MB SDRAM.

L1 Cache Memory
32KB within CPU.

L2 Cache Memory

256KB Pipeline Burst SRAM.

Expansion Memory

16MB, 32MB and 64MB SDRAM Modules extend system memory up to 80MB; installable in a single DIMM (dual-in-line memory module) slot in a compartment in the bottom of the notebook. SDRAM Modules are recommended but EDO RAM Modules will work.

Fujitsu product numbers:

16MB SDRAM, FPCEM05.

32MB SDRAM, FPCEM06.

64MB SDRAM, FPCEM07.

Installing an EDO RAM Module will cause your entire system to operate at slower EDO timing.

8MB EDO RAM, FPCEM01A.

16MB EDO RAM, FPCEM02A.

32MB EDO RAM, FPCEM03.

64MB EDO RAM, Third Party Only.

BIOS Memory

512KB Flash ROM.

256 Bytes CMOS-RAM with back-up battery.

Video RAM

2MB EDO RAM.

Mass Storage

Floppy Disk Drive

One modular 3.5" floppy disk drive which accommodates a 1.44MB or a 720KB floppy disk, Fujitsu Model FPCFDD03.

One optional external floppy disk drive, Fujitsu Model FPCFD02.

Hard Drive

One factory installed 1.6GB, 2.5" (12.7 mm) fixed hard drive unit.

One optional modular 3.2GB, 2.5" (12.7 mm) hard drive unit, Fujitsu Model FPCHDD03.

CD-ROM Drive

One modular, factory installed, 20-speed maximum, 2.5" (12.7 mm) drive, Fujitsu Model FPCCD06.

Appendices

Audio

SoundBlaster-compatible 16-bit stereo PCM/FM sound chip.
Spatializer 3D-Stereo multiple speaker effect support.
Stereo headphone jack, 1 Vrms, or less, minimum impedance 32 Ohms.
Stereo line in jack, 880 mVrms or less, minimum impedance 10K Ohms.
Mono microphone jack, 125 mVp-p or less, minimum impedance 10K Ohms.
Two built-in speakers, 28 mm diameter (Stereo).
One built-in monaural microphone.

Communication

Internal 56K fax/data/voice modem (56 Kbps data/voice transmission; 14.4 Kbps fax transmission, DSVD). (See page 3 for caution on modem.)
One IrDA compatible infrared port (4 Mbps).

Video

MPEG-1 video data decompression software.
Zoomed Video support via PC Card Slot 0.
Device Adapter for Bay 2
Device adapter for Bay 2, Fujitsu Model FPCBYA01.
Pre-Installed Software
Microsoft Windows 95.
LapLink by Traveling Software.
MegaPhone by Cypress Research
VirusScan by McAfee Associates.
Audio Rack 32 for Windows 95 by ESS Technology, Inc.
SoftPEG by CompCore Multimedia Inc.
Others dependent on options purchased.

Input/Output Connections

One Type III/two Type I/II PC Card slot: PCMCIA Standard 2.1 with CardBus support; Zoomed Video support via Slot 0.
One 6-pin mini DIN PS/2 compatible connector, for external keyboard, external mouse or external numeric keypad.

One 25-pin D-SUB two-way Centronics type connector for parallel input/output devices; Bi-directional, output only or ECP.
One 240-pin connector for docking devices.
One 15-pin D-SUB connector for VGA external monitor (see Display specifications).
One 9-pin D-SUB connector for RS-232C serial input/output devices.
One connector for USB (Universal Serial Bus) input/output devices.
One 25-pin special connector for external floppy disk drive connection.
One modular RJ-11 telephone line connector.
One stereo headphone jack (see Audio specifications).
One mono microphone jack (see Audio specifications).
One stereo line in jack (see Audio specifications).

Displays

Built-in color flat-panel DSTN passive matrix LCD display.
Diagonal dimension: 12.1"
800 x 600 pixel resolution, 64K colors.
640 x 480 pixel resolution, 16M colors.
SVGA, and VGA compatible.

External Monitor Support.

SVGA, and VGA compatible CRT displays.

1024 x 768 pixel resolution, 256 colors.

800 x 600 pixel resolution, 64K colors.

640 x 480 pixel resolution, 16M colors.

Keyboards

Built-in keyboard with all functions of 101 key

PS/2 compatible keyboards.

Total number of keys: 86.

Function keys: 12, F1 through F12.

Feature extension key: Fn.

Windows 95 keys: 3, two Start keys and one

Application key.

Key pitch: 19 mm.

Key stroke: 3 mm.

Built-in ErgoTrac pointing device with left and right buttons.

Built-in palmrest.

External Keyboard Support

PS/2 compatible.

External Numeric Keypad Support

PS/2 compatible.

External Mouse Support

PS/2 compatible.

Power

Batteries

One modular Lithium ion battery, Fujitsu

Model FPCBP11. Rechargeable, 10.8V, 3300

mAh. Operating time of up to 3 hours. Rapid

charge (notebook off or in suspend mode) in

about three (3) hours. Standard charge (normal

use with limited CD and hard drive access) in

about nine (9) hours.



CAUTION

Actual battery life will vary based on screen brightness, applications, features, power management settings, battery conditioning, and other customer preferences. CD-ROM or hard drive usage may also have a significant impact on battery life.

Dual Battery Configuration

Operating time of up to 6 hours. Rapid charge (notebook off or in Suspend Mode) in about 5 hours. Standard charge (normal use with limited CD and hard drive access) in about fifteen (15) hours.

AC Adapter

Autosensing 100-240V AC, 43W, supplying 16V DC to the Notebook, Fujitsu Model FPCAC05 which includes an AC cable.

Optional Auto/Airline Adapter

Autosensing 12/24V DC, 43W supplying 16V DC to the Notebook, Fujitsu Model FPC-CAA02.

Power Management

Save-to-Disk, Suspend, Idle and Standby power savings modes. When the battery is fully charged the computer can remain in Suspend mode for approximately 24 hours or more.

Dimensions and Weight

Overall Dimensions

Approximately 11.7" x 9.7" x 2.3"
(297 mm x 246 mm x 58 mm.)

Weight

Approximately 7.6 lbs (3.5 Kg) with floppy disk drive and battery installed.

Environmental Requirements

Temperature

Operating: 5° to 35° C (41° to 95° F).

Non-operating: -15° to 60° C (5° to 140° F).

Humidity

Operating: 20% to 85%, relative, non-condensing.

Non-operating: 8% to 85%, relative, non-condensing.

Altitude

Operating: 10,000 feet (3,048 m) maximum.

Electro-Static Discharge (ESD)

9 kV.

Theft Prevention Lock

Lock slot on the right side panel for use with

physical restraining security systems. The locking system by Kensington is recommended.

LifeBook 755Tx Specifications

Microprocessor

Intel Pentium P55CSLM 150MHz with MMX technology, L1 and L2 cache, PCI bus architecture, and CardBus architecture.

Memory

System Memory

32MB SDRAM.

L1 Cache Memory

32KB within CPU.

L2 Cache Memory

256KB Pipeline Burst SRAM.

Expansion Memory

16MB, 32MB and 64MB SDRAM Modules extend system memory up to 96MB; installable in a DIMM (dual-in-line memory module) slot in a compartment in the bottom of the notebook. SDRAM Modules are recommended but EDO RAM Modules will work.

Fujitsu product numbers:

16MB SDRAM, FPCEM05.

32MB SDRAM, FPCEM06.

64MB SDRAM, FPCEM07.

Installing an EDO RAM Module will cause your entire system to operate at slower EDO timing.

8MB EDO RAM, FPCEM01A.

16MB EDO RAM, FPCEM02A.

32MB EDO RAM, FPCEM03.

64MB EDO RAM, Third Party Only.

BIOS Memory

512KB Flash ROM.

256 Bytes CMOS-RAM with back-up battery.

Video RAM

2MB EDO RAM.

Mass Storage

Floppy Disk Drive

One modular 3.5" floppy disk drive which accommodates a 1.44MB or a 720KB floppy disk, Fujitsu Model FPCFDD03.

One optional external floppy disk drive, Fujitsu Model FPCFDA02.

Hard Drive

One factory installed 3.2GB, 2.5" (12.7 mm) fixed hard drive unit.

One optional modular 3.2GB, 2.5" (12.7 mm) hard drive unit, Fujitsu Model FPC HDD03.

CD-ROM Drive

One modular, factory installed, 20-speed maximum, 2.5" (12.7 mm) drive, Fujitsu Model FPCCD06.

Audio

SoundBlaster-compatible 16-bit stereo PCM/FM sound chip.

Spatializer 3D-Stereo multiple speaker effect support.

Stereo headphone jack, 1 Vrms, or less, minimum impedance 32 Ohms.

Stereo line input jack, 880 mVrms or less, minimum impedance 10K Ohms.

Mono microphone jack, 125 mVp-p or less, minimum impedance 10K Ohms.

Two built-in speakers, 28 mm diameter (Stereo).

One built-in monaural microphone.

Communication

Internal 56K fax/data/voice modem (56 Kbps data/voice transmission; 14.4 Kbps fax transmission, DSVD). (See page 3 for caution on modem.)

One IrDA compatible infrared port (4 Mbps).

Video

MPEG-1 video data decompression software. Zoomed Video support via PC Card Slot 0.

Device Adapter for Bay 2

Device adapter for Bay 2, Fujitsu Model FPCBYA01.

Pre-Installed Software

Microsoft Windows 95.

LapLink by Traveling Software.

MegaPhone by Cypress Research

VirusScan by McAfee Associates.

Audio Rack 32 for Windows 95 by ESS

Technology, Inc.

SoftPEG by CompCore Multimedia Inc.

Others dependent on options purchased.

Input/Output Connections

One Type III/two Type I/II PC Card slot: PCMCIA Standard 2.1 with CardBus support;

Zoomed Video support via Slot 0.

One 6-pin mini DIN PS/2 compatible connector, for external keyboard, external mouse or external numeric keypad.

One 25-pin D-SUB two-way Centronics type connector for parallel input/output devices; Bi-directional, output only or ECP.

One 240-pin connector for docking device.

One 15-pin D-SUB connector for VGA external monitor (see Display specifications).

One 9-pin D-SUB connector for RS-232C serial input/output devices.

One connector for USB (Universal Serial Bus) input/output devices.

One 25-pin special connector for external floppy disk drive connection.

One modular RJ-11 telephone line connector.

One stereo headphone jack (see Audio specifications).

One mono microphone jack (see Audio specifications).

One stereo line input jack (see Audio specifications).

Displays

Built-in color flat-panel TFT active matrix LCD display.

Diagonal dimension: 12.1"

800 x 600 pixel resolution, 64K colors.

640 x 480 pixel resolution, 16M colors.

SVGA, and VGA compatible.

External Monitor Support.

SVGA, and VGA compatible CRT displays.

1024 x 768 pixel resolution, 256 colors.

800 x 600 pixel resolution, 64K colors.

640 x 480 pixel resolution, 16M colors.

Keyboards

Built-in keyboard with all functions of 101 key PS/2 compatible keyboards.

Total number of keys: 86.

Function keys: 12, F1 through F12.

Feature extension key: Fn.

Windows 95 keys: 3, two Start keys and one

Application key.

Key pitch: 19 mm.

Key stroke: 3 mm.

Built-in ErgoTrac pointing device with left and right buttons.

Built-in palmrest.

External Keyboard Support

PS/2 compatible.

External Numeric Keypad Support

PS/2 compatible.

External Mouse Support

PS/2 compatible.

Power**Batteries**

One modular Lithium ion battery, Fujitsu Model FPCBP11. Rechargeable, 10.8V, 3300 mAh. Operating time of up to 3 hours. Rapid charge (notebook Off or in Suspend mode) in about three (3) hours. Standard charge (normal use with limited CD and hard drive access) in about nine (9) hours.

**CAUTION**

Actual battery life will vary based on screen brightness, applications, features, power management settings, battery conditioning, and other customer preferences. CD-ROM or hard drive usage may also have a significant impact on battery life.

Dual Battery Configuration

Operating time of up to 6 hours. Rapid charge (notebook Off or in Suspend mode) in about 5 hours. Standard charge (normal use with limited CD and hard drive access) in about fifteen (15) hours.

AC Adapter

Autosensing 100-240V AC, 43W, supplying 16V DC to the notebook, Fujitsu Model FPCAC05 which includes an AC cable.

Optional Auto/Airline Adapter
Autosensing 12/24V DC, 43W supplying
16V DC to the Notebook, Fujitsu Model
FPCCAA02.

Power Management

Save-to-Disk, Suspend, Idle and Standby power
savings modes. When the battery is fully
charged the computer can remain in suspend
mode for approximately 24 hours or more.

Dimensions and Weight

Overall Dimensions

Approximately 11.7" x 9.7" x 2.3".
(297 mm x 246 mm x 58 mm.)

Weight

Approximately 7.6 lbs (3.5 Kg) with floppy disk
drive and battery installed.

Environmental Requirements

Temperature

Operating: 5° to 35° C (41° to 95° F).

Non-operating: -15° to 60° C (5° to 140° F).

Humidity

Operating: 20% to 85%, relative, non-
condensing.

Non-operating: 8% to 85%, relative, non-
condensing.

Altitude

Operating: 10,000 feet (3,048 m) maximum.

Electro-Static Discharge (ESD) 9 kV.

Theft Prevention Lock

Lock slot on the right side panel for use with
physical restraining security systems. The lock-
ing system by Kensington is recommended.

LifeBook 765Tx Specifications

Microprocessor

Intel Pentium P55CSLM 166MHz with MMX
technology, L1 and L2 cache, PCI bus architec-
ture, and CardBus architecture.

Memory

System Memory

32MB SDRAM.

L1 Cache Memory

32KB within CPU.

L2 Cache Memory

256KB Pipeline Burst SRAM.

Expansion Memory

16MB, 32MB and 64MB SDRAM Modules
extend system memory up to 96MB; installable
in a DIMM (dual-in-line memory module) slot
in a compartment in the bottom of the note-
book. SDRAM Modules are recommended but
EDO RAM Modules will work.

Fujitsu product numbers:

16MB SDRAM, FPCEM05.

32MB SDRAM, FPCEM06.

64MB SDRAM, FPCEM07.

Installing an EDO RAM Module will cause
your entire system to operate at slower
EDO timing.

8MB EDO RAM, FPCEM01A.

16MB EDO RAM, FPCEM02A.

32MB EDO RAM, FPCEM03.

64MB EDO RAM, Third Party Only.

Appendices

BIOS Memory
512KB Flash ROM.
256 Bytes CMOS-RAM with back-up battery.

Video RAM
2MB EDO RAM.

Mass Storage
Floppy Disk Drive
One modular 3.5" floppy disk drive which accommodates a 1.44MB or a 720KB floppy disk, Fujitsu Model FPCFDD03.
One optional external floppy disk drive, Fujitsu Model FPCFDD02.

Hard Drive
One factory installed 3.2GB, 2.5" (12.7 mm) fixed hard drive unit.
One optional modular 3.2GB, 2.5" (12.7 mm) hard drive unit, Fujitsu Model FPCHDD03.

CD-ROM Drive
One modular, factory installed, 20-speed maximum, 2.5" (12.7 mm) drive, Fujitsu Model FPCCD06.

Audio
SoundBlaster-compatible 16-bit stereo PCM/FM sound chip.
Spatializer 3D-Stereo multiple speaker effect support.
Stereo headphone jack, 1 Vrms, or less, minimum impedance 32 Ohms.
Stereo line in jack, 880 mVrms or less, minimum impedance 10K Ohms.
Mono microphone jack, 125 mVp-p or less, minimum impedance 10K Ohms.
Two built-in speakers, 28 mm diameter (Stereo).
One built-in monaural microphone.

Communication
Internal 56K fax/data/voice modem (56 Kbps data/voice transmission; 14.4 Kbps fax transmission, DSVD). (See page 3 for caution on modem.)
One IrDA compatible infrared port (4 Mbps).

Video
MPEG-1 video data decompression software.
Zoomed Video support via PC Card Slot 0.

Device Adapter for Bay 2
Device adapter for Bay 2, Fujitsu Model FPCBYA01.

Pre-Installed Software
Microsoft Windows 95.
LapLink by Traveling Software.
MegaPhone by Cypress Research
VirusScan by McAfee Associates.
Audio Rack 32 for Windows 95 by ESS Technology, Inc.
SoftPEG by CompCore Multimedia Inc.
Others dependent on options purchased.

Input/Output Connections
One Type III/two Type I/II PC Card slot: PCMCIA Standard 2.1 with CardBus support; Zoomed Video support via Slot 0.
One 6-pin mini DIN PS/2 compatible connector, for external keyboard, external mouse or external numeric keypad.
One 25-pin D-SUB two-way Centronics type connector for parallel input/output devices; Bi-directional, output only or ECP.

One 240-pin connector for docking device.
One 15-pin D-SUB connector for VGA external monitor (see *Display specifications*).
One 9-pin D-SUB connector for RS-232C serial input/output devices.
One connector for USB (Universal Serial Bus) input/output devices.
One 25-pin special connector for external floppy disk drive connection.
One modular RJ-11 telephone line connector.
One stereo headphone jack (see *Audio specifications*).
One mono microphone jack (see *Audio specifications*).
One stereo line input jack (see *Audio specifications*).

Displays

Built-in color flat-panel TFT active matrix LCD display.
Diagonal dimension: 12.1"
800 x 600 pixel resolution, 64K colors.
640 x 480 pixel resolution, 16M colors.
SVGA, and VGA compatible.

External Monitor Support.
SVGA, and VGA compatible CRT displays.
1024 x 768 pixel resolution, 256 colors.
800 x 600 pixel resolution, 64K colors.
640 x 480 pixel resolution, 16M colors.

Keyboards

Built-in keyboard with all functions of 101 key PS/2 compatible keyboards.
Total number of keys: 86.
Function keys: 12, F1 through F12.
Feature extension key: Fn.
Windows 95 keys: 3, two Start keys and one Application key.
Key pitch: 19 mm.
Key stroke: 3 mm.
Built-in ErgoTrac pointing device with left and right buttons.
Built-in palmrest.

External Keyboard Support
PS/2 compatible.

External Numeric Keypad Support
PS/2 compatible.

External Mouse Support
PS/2 compatible.

Power

Batteries

One modular Lithium ion battery, Fujitsu Model FPCBP11. Rechargeable, 10.8V, 3300 mAh. Operating time of up to 3 hours. Rapid charge (notebook Off or in Suspend mode) in about three (3) hours. Standard charge (normal use with limited CD and hard drive access) in about nine (9) hours.



CAUTION

Actual battery life will vary based on screen brightness, applications, features, power management settings, battery conditioning, and other customer preferences. CD-ROM or hard drive usage may also have a significant impact on battery life.

Appendices

Dual Battery Configuration

Operating time of up to 6 hours. Rapid charge (notebook Off or in Suspend mode) in about 5 hours. Standard charge (normal use with limited CD and hard drive access) in about fifteen (15) hours.

AC Adapter

Autosensing 100-240V AC, 43W, supplying 16V DC to the notebook, Fujitsu Model FPCAC05 which includes an AC cable.

Optional Auto/Airline Adapter

Autosensing 12/24V DC, 43W supplying 16V DC to the notebook, Fujitsu Model FPCCAA02.

Power Management

Save-to-Disk, Suspend, Idle and Standby power savings modes. When the battery is fully charged the computer can remain in suspend mode for approximately 24 hours or more.

Dimensions and Weight

**Overall Dimensions
Approximately 11.7" x 9.7" x 2.3"
(297 mm x 246 mm x 58 mm.)**

Weight

Approximately 7.6 lbs (3.5 Kg) with floppy disk drive and battery installed.

Environmental Requirements

Temperature

**Operating: 5° to 35° C (41° to 95° F).
Non-operating: -15° to 60° C (5° to 140° F).**

Humidity

**Operating: 20% to 85%, relative, non-condensing.
Non-operating: 8% to 85%, relative,
non-condensing.**

Altitude

Operating: 10,000 feet (3,048 m) maximum.

Electro-Static Discharge (ESD)

9 kV.

Theft Prevention Lock

Lock slot on the right side panel for use with physical restraining security systems. The locking system by Kensington is recommended.

Approvals

Emissions

FCC Part 15, FCC Part 68, FTZ.

Safety

UL, C-UL, CSA.

FCC Certification

See statement at the front of this User's Guide.

DOC (Industry Canada) Certification

See statement at the front of this User's Guide.

Popular Accessories

Other accessories are available, contact your authorized Fujitsu reseller.

Optional second modular Lithium ion battery, Fujitsu Model FPCBP11.

Optional modular 3.2GB hard drive, Fujitsu Model FPCHDD03.

LANdock, Fujitsu Model FPCDS11. The LANdock provides connections for:

- RS-232C Serial device.**
- Parallel device.**
- VGA/SVGA/XGA monitor.**
- Mouse (PS/2).**
- Keyboard (PS/2).**
- Slot for Two Type II/one Type III PC Cards without Zoomed Video support.**
- Telephone line (RJ-11).**
- 10/100 Base-T Ethernet line (RJ-45).**
- MIDI/joystick device.**
- Two USB devices.**
- External floppy disk drive.**
- Stereo Headphone.**
- Microphone.**
- Stereo Line In.**

The LANdock is powered from a power adapter which is included with the LANdock, Fujitsu Model FPCAC06.



CAUTION

The AC adapter for the LANdock and the Port Replicator is not the same as the one for your notebook. **Do not** use them interchangeably.

Port Replicator, Fujitsu Model FPCPR07. The Port Replicator provides connections for:

- RS-232C Serial device.**
- Parallel device.**
- VGA/SVGA/XGA monitor.**
- Mouse (PS/2).**
- Keyboard (PS/2).**
- Telephone line (RJ-11).**
- Two USB devices.**
- External floppy disk drive.**
- Microphone.**
- Stereo Line In.**

The Port Replicator is powered from a power adapter which is included with the Port Replicator Fujitsu Model FPCAC06.

Appendix B Glossary

AC Adapter

A device which converts the AC voltage from a wall outlet to the DC voltage needed to power your Computer.

Active-Matrix Display

A type of technology for making flat-panel displays which has a transistor or similar device for every pixel on the screen.

Auto/Airline Adapter

A device which converts the DC voltage from an automobile cigarette lighter or aircraft DC power outlet to the DC voltage needed to power your notebook.

BIOS

Basic Input-Output System. A computer program and set of default parameters stored in ROM which tests and operates your computer when you turn it on until it loads your installed operating system from disk. Information from the BIOS is transferred to the installed operating system to provide it with information on the configuration and status of the hardware.

Bit

An abbreviation for binary digit. A single piece of information which is either a one (1) or a zero (0).

bps

An abbreviation for bits per second. Used to describe data transfer rates.

Boot

To start-up a computer and load its operating system from disk, ROM or other storage media into RAM.

Bus

An electrical circuit which passes data between the CPU and the sub-assemblies inside your computer.

Byte

8 bits of parallel binary information.

Cache Memory

A block of memory built into the micro-processor which is much faster to access than your system RAM and used in specially structured ways to make your overall data handling time faster.

CardBus

A faster, 32-bit version of the PC Card interface which offers performance similar to the 32-bit PCI architecture.

CD-ROM

Compact disc read only memory. This is a form of digital data storage which is read optically with a laser rather than a magnetic head. A typical CD-ROM can contain about 600MB of data and is not subject to heads crashing into the surface and destroying the data when there is a failure nor to wear from reading.

CHS Translation

Cylinder, head and sector translation. Conversion of hard drive access addressing to the cylinder, head and sector form. The terminology is historical left from the days when data was stored on a series of cylindrical drums. The head designates the reading device, similar to the head on a cassette recorder only mounted on a movable arm. Another addressing method is LBA.

CMOS RAM

Complementary metal oxide semiconductor random access memory. This is a technology for manufacturing random access memory which requires very low levels of power to operate.

COM Port

Abbreviation for communication port. This is your serial interface connection.

Command

An instruction which you give your operating system. Example: run a particular application or format a floppy disk.

Configuration

The combination of hardware and software that makes up your system and how it is allocated for use.

CRT

Cathode Ray Tube. A display device which uses a beam of electronic particles striking a luminescent screen. It produces a visual image by varying the position and intensity of the beam.

Data

The information a system stores and processes.

DC

Direct current. A voltage or current that does not fluctuate periodically with time.

Default Value

A preprogrammed value to be used if you fail to set your own.

DIMM

Dual-in-line memory module.

Disk

A spinning platter of magnetic data storage media. If the platter is very stiff it is a hard drive, if it is highly flexible it is a floppy disk, if it is a floppy disk in a hard housing with a shutter it is commonly called a diskette.

Disk Drive

The hardware which spins the disk and has the heads and control circuitry for reading and writing the data on the disk.

Diskette

A floppy disk in a hard housing with a shutter.

DMA

Direct Memory Access. Special circuitry for memory to memory transfers of data which do not require CPU action.

DOS

Disk Operating System (MS-DOS is a Microsoft Disk Operating System).

Driver

A computer program which converts application and operating system commands to external devices into the exact form required by a specific brand and model of device in order to produce the desired results from that particular equipment.

ECP

Extended Capability Port. A set of standards for high speed data communication and interconnection between electronic devices.

Appendices

ESD

Electro-Static Discharge. The sudden discharge of electricity from a static charge which has built-up slowly. Example: the shock you get from a doorknob on a dry day or the sparks you get from brushing hair on a dry day.

Extended Memory

All memory more than the 640KB recognized by MS-DOS as system memory.

FCC

Federal Communication Commission.

Floppy Disk

A spinning platter of magnetic data storage media which is highly flexible.

GB

Gigabyte.

Gigabyte

1,073,741,824 bytes
(2 raised to the thirtieth power).

Hard drive

A spinning platter of magnetic data storage media where the platter is very stiff.

Hexadecimal

A decimal notation for the value of a 4 bit binary number. (0-9,A, B, C, D, E,F) Example: 2F in hexadecimal = 00101111 in binary = 47 in decimal.

I/O

Input/Output.Data entering and leaving your computer in electronic form.

I/O Port

The connector and associated control circuits for data entering and leaving your computer in electronic form.

IDE

Intelligent Drive Electronics.A type of control interface for a hard drive which is inside the hard drive unit.

Impedance

The amount of resistance to the flow of electric current.

Infrared

Light just beyond the red portion of the visible light spectrum which is invisible to humans.

IR

An abbreviation for infrared.

IrDA

Infrared Data Association. An organization which produces standards for communication using infrared as the carrier.

IRQ

Interrupt Request. An acronym for the hardware signal to the CPU that an external event has occurred which needs to be processed.

KB

Kilobyte.

Kilobyte

1,024 bytes (2 raised to the tenth power).

LAN

Local Area Network. An interconnection of computers and peripherals within a single limited geographic location which can pass programs and data amongst themselves.

LBA

Logical Block Addressing. A method of locating data stored on a disk.

LCD

Liquid Crystal Display. A type of display which makes images by controlling the orientation of crystals in a crystalline liquid.

Lithium ion battery

A type of rechargeable battery which has a high power-time life for its size and is not subject to the memory effect as Nickel Cadmium batteries.

LPT Port

Line Printer Port. A way of referring to parallel interface ports because historically line printers were the first and latter the most common device connected to parallel ports.

MB

Megabyte.

Megabyte

1,048,576 bytes (2 raised to the twentieth power).

Megahertz

1,000,000 cycles per second.

Memory

A repository for data and applications which is readily accessible to your computer CPU.

MHz

Megahertz.

MIDI

Musical Instrument Digital Interface. A standard communication protocol for exchange of information between computers and sound producers such as synthesizers.

Modem

A contraction for **MOdulator-DEModulator**. The equipment which connects a computer or other data terminal to a communication line.

MMX Technology

MMX technology is an Intel processor enhancement that improves multimedia and communication applications. The Pentium processor with MMX technology boasts three primary architectural design enhancements: 57 powerful new instructions specifically designed to manipulate and process video, audio and graphical data efficiently; Single Instruction Multiple Data (SIMD) enabling one instruction to perform the same function on multiple pieces of data; and more L1 cache for a total of 32KB.

Monaural

A system using one channel to process sound from all sources.

MPU-401

A standard for MIDI interfaces and connectors.

NTSC

National TV Standards Commission. The standard for TV broadcast and reception for the USA.

Operating System

A group of control programs that convert application commands, including driver programs, into the exact form required by a specific brand and model of microprocessor in order to produce the desired results from that particular equipment.

PAL

Phase Alternation by Line. The standard for color television in Western Europe and most of Asia and Africa.

Parallel Port

A connection to another device through which data is transferred as a block of bits simultaneously with a wire for each bit in the block and with other wires only for control of the device not for transfer of data.

Partition

A block of space on a hard drive which is set aside and made to appear to the operating system as if it were a separate disk, and addressed by the operating system accordingly.

PCMCIA

PCMCIA is a trademark of the Personal Computer Memory Card International Association. The Personal Computer Memory Card International Association is an organization that sets standards for add-in cards for personal computers.

Peripheral Device

A piece of equipment which performs a specific function associated with but not integral to a computer. Examples: a printer, a modem, a CD-ROM.

PIO

Parallel Input/Output.

Pitch (keyboard)

The distance between the centers of the letter keys of a keyboard.

Pixel

The smallest element of a display, a dot of color on your display screen. The more pixels per area the clearer your image will appear.

POST

Power On Self Test. A program which is part of the BIOS which checks the configuration and operating condition of your hardware whenever power is applied to your Computer. Status and error messages may be displayed before the operating system is loaded. If the self test detects failures that are so serious that operation can not continue, the operating system will not be loaded.

Program

An integrated set of coded commands to your computers telling your hardware what to do and how and when to do it.

PS/2

An IBM series of personal computers which established a number of standards for connecting external devices such as keyboards and monitors.

RAM

Random Access Memory. A hardware component of your computer that holds binary information (both program and data) as long as it has the proper power applied to it.

RAM Module

A printed circuit card with memory and associated circuitry which allows the user to add additional memory to the computer without special tools.

Reset

The act of reloading the operating system. A reset erases all information stored in RAM.

Restart

See Reset.

Resume

To proceed after interruption. In your Computer this refers to returning to active operation after having been in one of the suspension states.

ROM

Read Only Memory. A form of memory in which information is stored by physically altering the material. Data stored in this way can not be changed by your Computer and does not require power to maintain it.

SCSI

Small Computer Systems Interface (pronounced scuzzy). An American National Standards Institute (ANSI) standard for connecting multiple (up to 7) high speed parallel devices to a computer.

SDRAM

Synchronous Dynamic Random Access Memory.

Serial Port

A connection to another device through which data is transferred one bit at a time on a single wire with any other wires only for control of the device not for transfer of data.

Shadow RAM

A technique of copying data or applications stored in ROM (Read Only Memory) into RAM (Random Access Memory) for access during actual operation. RAM is much faster to access than ROM, however ROM contents are not lost when power is removed. Shadowing allows permanently stored information to be rapidly accessed.

SRAM

Static random access memory. A specific technology of making RAM which does not require periodic data refreshing.

Status Indicator

A display which reports the condition of some portion of your hardware. On your Computer this is an LCD screen just above the keyboard.

Stereo (audio)

A system using two channels to process sound from two different sources.

A p p e n d i c e s**Stroke (keyboard)**

The amount of travel of a key when it is pressed from resting to fully depressed.

Suspend

To make inoperative for a period of time. Your notebook uses various suspension states to reduce power consumption and prolong the charge of your battery.

SVGA

Super VGA.

S-Video

Super Video. A component video system for driving a TV or computer monitor.

System Clock

An oscillator of fixed precise frequency which synchronizes the operation of the system and is counted to provide time of day and date.

TFT

Thin Film Transistor – A technology for flat display panels which uses a thin film matrix of transistors to control each pixel of the display screen individually.

UL

Underwriters Laboratories – An independent organization that tests and certifies the electrical safety of devices.

VGA

Video Graphics Array. A video display standard originally introduced by IBM with the PS/2 series of personal computers.

VRAM

Video Random Access Memory. A memory dedicated to video display data and control.

Write Protect

Prevent alteration of the binary state of all bits in a storage media. Example: all information on a device such as a floppy diskette; a block of space in a storage media such as a partition of a hard drive; a file or directory of floppy diskette or hard drive.

XGA

Extended VGA.

Zoomed Video

A PC Card port which allows notebook PCs to deliver full screen broadcast quality video through third party PC Cards, including TV tuners, video capture, and MPEG full-motion video.

I n d e x

3D-Stereo	3-4,48,149, 152,155	Auto/Airline Adapter	7,10,11,20,24 27,28,29, 128,145, 150,154, 157,159	Block Addressing.	62,162
AC adapter	2-3,7,10-12,20-21,24-29 98-99,107,111, 121,150, 153,157-159	Batteries	4,10, 17-18,20-21,25-29,44 53,97,102,127-132,143,145,150 153,156,162	Block transfer	62
AC Adapter indicator	20-21	Battery	2-4,6-7,10-12,18, 20-21,24 26-29,40-43,46,82,85,96-98,101-102 127-132, 134,140, 143-145,148 150-151,153-157,162,165	Boot	24,51-55,58,63-64,78, 80,88-89 118, 121,125, 133-134,139-141, 144,159
Access indicators	21, 23-24,39	Battery Level indicator.	21,28-29	Boot device	53
Active-Matrix Display	159	Battery life	18,27,41-42,82 85,143,145,150,153,156	Boot Options.	24,58,63-64,121,125,139
Adjustment feet.	9-10,19,36-37,111	Battery power	6,11,40-41	Boot Sector Protectio	80
Advanced Menu	46-47,51,65-67, 72,74 76, 120,136-137	Bi-directional	69,149, 152,155,	Boot sequence.	51-52, 63,118 133-134,139-140
Applications	4,11,15,19,22,25,27,38,46 94, 98-99,105,107, 120,130, 133,136 141,150,153,156,162,164	BIOS	6,11-12,38-40,44-47,51-55,63,67 79-80,88-89,91-92, 120-121,123-124,126 133-134,137-141,148,151,155,159,163	Bootable CD-ROM.	53,63,123
Arrow icon.	21	BIOS setup utility	6,11-12,38-40,44-47 51-53,55,67,79,89,120,124,133-134,141	Booting.	12,53,63,72
Audio Features submenu.	47,66,73-74,120			Bridge battery	4,26-27,97,102
Audio functions	66,73-74			Brightness	5-6,18, 27,38,132 135,145,150,153,156
Auto Suspend Timeout.	83			Cache Memory.	148,151, 154,159
				Calendar	56

I n d e x

- CapsLock** 6, 20,23
CardBus 148-149,151-152,154-155,159
CD automatic insertion function . . 22,37,145
CD player 47-48
CD-ROM 2-3,6,14,17, 19-22,24,26-28
 36-38, 49,52-53,57,63,89,96-97,100
 117,119-121,123,132,141,145,148
 150,152-153,155-156,159,163,
CD-ROM access 21-22,121,132,145
CD-ROM drive 2-3, 6,17,19-22,26-27
 36-37,53,57,89,96-97,100,119-121
 123,141,148,152,155
CD-ROM holder tray 37
Charging indicator 21,28
Checksum 140
CHS Translation 159
Cigarette lighter 159, 11,128
Closed Cover Switch 5-6,134-135
CMOS RAM 140,160
COM Port 9,68,160
Communication mode 65
Compensation 33,65,76
Conditions of Use 3,12
Configuration Label 9-10,119
Control Panel 22, 31,34,38-39,42,46,48
 56, 104,113
CPU 43,45,83,87, 133,148
 151, 154,159-162
CRT 9,65,76, 150,153, 156,160
Cursor 4,6,12,30-33,40-41,55,64
 72,76,80,87,89
Custom Toolbar 41
Cylinders 60-61
Data 1,3-4,6,11-12,14,21-22,24,27
 29,35,38-39,43-44,46-49,52-54,61-62
 69,77-78,94, 102-103,113, 115,122
 138-141, 149,152, 155,159-165
Data Security 1,11,52-54,77
Date 165,52-53,56-57,118
DC 7,10-11,111,115
 150,153-154,157,159-160
DC power 7,10-11,111,115,159
Dead battery alarm level 29
Dead Battery Suspend Mode 29,127-128
 130-131
Dead Battery Warning condition 43
Default Value 160
Device adapter 2-3,7, 34,97-100,102
 149, 152,155
Digital PBX 9,106

- DIMM 148, 151,154, 160,108**
- Disk 2-3,6-8,12,17, 20,23-25,34-36**
 41,43,45, 49,52-53,57,60,63, 69,79-80
 82,84-85,93,95-98,100-103,107,111
 115,119,122,138-139,141,148-149
 151-152,154-163
- Disk errors 25**
- Diskette 57,69,79,89, 122,138,160,165**
- Diskette drive 89,138**
- Display 3-6,12-13,17-18,23-25,33**
 38,41-43,45, 47,53-54,64-66, 75-76
 82-83,87,91, 93,98-99,106-107,110
 113-114,125,132,134-136,139,141
 149,152-153,156,159-160,162-165
- Display compression 136**
- Display panel 5-6,17-18,23-25,33,65**
 87,106,114
- DMA 160,65,67-69**
- DMA channel 65,68**
- Docking 8-9,65,96,110-114,119**
 121,149, 152,156
- Docking port 8-9,96,112**
- Docking Station 9,112,121**
- Double click 22,31,41**
- Dragging 31,40,48**
- Drive Designators 52**
- Driver 120, 124-126,137, 160,163**
- ECP 69,149,152,155,160**
- ECP mode 69**
- Electro-static discharge 109-110,151**
 154,157, 161,
- ErgoTrac 4-6, 12,17,30-33,43,72**
 123,150, 153,156,
- Error message 12,24,45,54, 134,137-139**
- ESD 109-110,151,154,157,161**
- Ethernet 158,46**
- Exit Menu 51, 55,64,76,80, 87,89-92**
- Extended Memory 161,58,110,138**
- External Floppy Disk Drive 7-8,34,52,69**
 96,102, 107,111, 115,148-149
 151-152,155-156,158
- External monitor 4,8-9,33, 53,95-96**
 106,111, 115,134, 137,149-150, 152-153,156
- F1 key 54-55,139**
- F10 key 55**
- F2 key 12,52-54,110,133,139**
- F5 key 55**
- F9 key 55**
- Faulty battery 27**
- Fax 3-4,42, 46,48,103**
 118,141,149,152,155
- FCC 157,161**

Index

- Feet** 9-10,19, 36-37,111,151,154,157
- File transfers** 4,46,48
- Fixed Disk** 60,80,138-139
- Floppy disk** 2-3,6-8,12,17,20,23-25
34-36,49,52-53,57, 63,69,79,95-98,102-103
107, 111,115, 119,122, 138-139,148-149
151-152, 154-158,160-161
- Floppy disk drive** 2-3,6-8,17, 20,23-24
34-36,52,57, 69,95-98,102-103,107
111,115,119,122,138-139,148-149
151-152,154-158
- Floppy Disk Drive Access indicator** 23,35
- Floppy disk format** 34,53,63
- Fn key** 32-33,53, 106,134
- Full Duplex** 69
- Function Keys** 32-33,150,153,156
- GB** 161
- Gigabyte** 161
- Half Duplex** 69
- Hard disk** 41, 43,63,82,85, 101,141
- Hard Disk Timeout** 82,85
- Hard Drive** 3, 6-7,12,17,20,22, 24,26-27
29,38,40, 42-46,49,53,57,60-63,80
82-84,89, 93-94,96-97,100-101,119
123,133,138-139,148,150,152-153
155-157, 159-161,163, 165
- Hard Drive Access** 20, 22,45,150
153,156-157,159
- Hard Drive Access Indicator** 22
- Hard drive format** 53,63
- Hardware Data Security** 11
- Hardware security passwords** 12
- Hardware volume control** 34,48
- Head** 159,61-62
- Headphones** 8,95-96,105,120
- Hexadecimal** 161,68,73
- Hot Plug Function** 72
- I/O** 65, 67,68,73,83, 126,139, 158,161
- Icon** 14,21-22,26,28,31
40,42,46,56, 114,132
- IDE** 57,59-62,69,103, 121,123, 133,161
- Idle Mode** 45,83,85,87
- Impedance** 149,152,155,161
- Inactivity shutoff** 82
- Inactivity suspension** 83
- Infrared** 4,8-9,17,46-49
68, 149,152, 155,161
- Internal Hard Drive** 22,38,40,43-44
57,63,80,93-94,133
- Internal modem** 8-9,17,38,46
48,70,96, 106,141

- Interrupt level** 65, 68-69,74
- IR**, 68,161
- IrDA** 4,9,46, 149,152, 155,161
- IRQ** 68-70,74, 161,
- Joystick** 43,66, 111,158
- KB**, 161,58
- Keyboard** 4-6,8,10,17, 19,23-24
30, 32-33,39,45,49,66, 71-72,78,95-96
106,111-113, 115,119, 123-124,130
135-136,139,149-150,152-153
155-156,158,163-165
- Keyboard/Mouse Features Submenu** . . . 66,71
- Kilobyte**, 161
- Label**, 9-10,34,37, 104,119-120
- LAN** 26,28,103,132, 162,
- LANdock** 95, 110-115,121-122, 124,158
- LBA** 62, 159,162
- LBA Mode Control**, 62
- LCD** 6,87, 136,149,153,156,162,164
- License Agreement**, 13
- Lithium ion battery**, 2-3,6-7
10-11,20,24, 26-28,40,96-98
101-102,150,153,156-157,162
- Low battery alarm** 29,130
- LPT Port** 9,69,162
- Main Menu** 51, 53-54,56-59,64
110,121-122,124,133
- Manuals** 15
- Maximum Battery Life** 18,41-42,85,145
- Maximum Performance**, 41-42,85
- MB** 162,57-58,110
- Megabyte** 162
- Megahertz**, 162
- Memory** 9-10,28, 34,40,43-45,54,58,84
91-96,108-111,119,124-125,138
140,148,151,154-155,159-165
- Memory Capacity** 10,34,108-110
- Memory upgrade compartment** 9-10,108
- Memory upgrade module**, 10,45,93
95-96,108-111,124,138
- MHz** 62
- Microphone** 4-8,34,48,95-96
105,149, 152,155-156, 158,
- MIDI** 158,162, 48,66,111
- MMX Technology** 3,148,151,154,162
- Modem** 3-4,8-9,17,26, 38,41-43,45-46
48-49,70,84,96, 103,106, 117,119
125, 132,141, 149,152, 155,162-163
- Monaural** 149,152, 155,162
- Monitor** . 4,8-9,33, 53, 95-96,106,111, 114-115
134,137, 139,149-150, 152-153,156, 158,165

Index

- Mono microphone**, 4,8,96, 105,
149, 152,155-156
- Mouse** 4,8,30-33,66,71-72,78,87
95-96,106,111-113,115,119,123-124
149-150,152-153,155-156,158
- Mouse cursor** 31,72
- MPEG file player**. 47
- MPU**. 401,162
- Multi-function bay** 2-3,5-7, 9-10,20,28
34, 53,57,95,97-100, 102,122,129,131
- Multi-Sector** 62
- NTSC**. 162
- Numeric keypad**. 8,23, 32-33,96
149-150,152-153,155-156
- NumLk**. 6,20,23,33
- NVRAM** 139
- Operating system**,. 1,4, 11-12,14-15
24-25,34-35,38,46,51-54,56,64, 80,88-89
91,94,101,113,115,120-121,123-124
133,137-139,141,159-160,163-164
- Output Only**. 69,149,152, 155,
- PAL** 163
- Parallel port**. 163,8-9,65,69,
95-96,105,111, 115,125
- Parity** 139
- Partition**, 94, 163,165
- Password** 11-12,54,78-80,123,133
- Password on Boot** 78,80
- PC Card** 4,6-7,20,23-24,40,46,48
84,96,103-105,111,113,119,126
132,138,149,152,155,159,165
- PC Card Access Indicator** 23
- PC-Doctor** 4,119
- PCMCIA** 149,152, 155,163
- Peripheral Device**. 163
- Peripherals**. 46, 66-70,148,162
- PHDISK** 45,93-94
- PIO** 163,62
- Pitch**. 150,153,156,163
- Pixel**. 33,76, 136,149-150
153, 156,159, 163,165
- Pointing device** -6,13,17, 30-31,33
72,123,150,153,156
- Port replicator** 9,95,112-115,158,
- POST**. 24, 52,54,64,80,110,125
134-135,163
- Power adapter** 20,27,29,41-42
102,108, 127-132,158
- Power Indicator** 19,29,39

- Power Management** 6,26-27,29,38-42
45-46, 51,53, 78,80-81,130,135-136
145,150, 153-154,156-157
- Power On Self Test.** 24,52, 54,64,80,110
117, 125, 134-135,138-139, 163,
- Power Savings** 6,38-40, 42,44,46
51,55,81-85,87, 130,132, 135,150, 154,157
- Power source** 24, 29,43,118,129,131
- Power switch** 7-8,19-21,23-26,
29,43, 52,78,84,97, 105,108,110,112
113,118,123,127-131,140
- PowerPanel** 28,38-44,46,81,130, 132,135
- PowerPanel Toolbar** 28,40-41,43-44
- Pre-installed software.** 4,12,14-15, 17,38, 4
117,141,149,152,155
- Presentation Profile** 42
- Primary Master.** 123
- Product code.** 13
- Program** 41-42,47,49, 53-54,119,140
159-160, 163-164,
- PS/2** 8, 30,72,96,106,113,115,124,149
150,152,153,155,156,158,163,165
- Quiet boot** 52
- RAM** 3,103,110, 138,140,
148,151,154-155,159-160,164
- Real time clock** 140
- Recovery CD-ROM** 2,14,38,141
- Registration** 1-2,14,26
- Reset.** 12,52-53,164
- Restart** 22,25, 34,43,45-46,52,54,78
93-94,113,115, 123-126,129, 138,164
- Resume,** 5-6,19,21,25, 29,39-40
42-46,78,80,84-85,87,112,114,123
129-130,132, 135-136,139, 164,
- Resume On Time,** 85
- RJ-11** 2, 8-9,96,106,111,113
115, 149,152, 156,158
- RJ-45.** 111,158
- ROM.** 148,151,155,159,164
- RS-232C.** 9,96,105,149,152,156,158
- S-Video** 165
- Save-To-Disk File Allocation** 38,45,51,93
- Save-to-Disk Mode** 19,39-40,
43-45,80,84-85,114
- Scr Lk Indicator** 23
- SCSI** 164,103
- SDRAM** 3,108,148,151,154,164
- Second Lithium ion battery** 3,11,20
24,26,28,96
- Sectors** 61-62
- Security** 151, 154,157, 1,11-12
51-55, 77-80,106,122-123,133

Index

- Security Menu 11,51,77, 79-80,123,133
- Serial port -9,68,87
95-96,105, 111,115, 125,164
- Setup utility. . . 6,11-12, 24,38-40,44-47,51-56
58-60,63-65,67,71, 73,75-77,79-81,86-87
89-92, 110,120-124,130,132-135,138-141
- Shadow RAM 164,140
- Shortcut Menu. 33
- Shorted batteries. 28
- Shutdown 25-26,29,52,104
113, 115,119, 123,132
- Software Data Security 11
- Software security feature 12
- Software volume control 34
- SoundBlaster 3,149,152,155
- Speaker 3,7-8,149, 152,155
- Speakerphone 4,34,42, 46,48-49
- SRAM. 96, 103,138,148,151,154,164
- Standby Mode 43, 45,85,135
- Standby Timeout 83
- Start Menu 26,33, 41-44,47
52,93,112-113, 115,123
- Status Indicator 5-6,17,19-20,23,26
28-29,39,84,127-132,134,164
- Stereo 3-4,7-8,48, 95-96,105,149
152,155-156, 158,164
- Stereo headphones 105
- Stereo line in . 4,7-8,95-96,105,149,155, 158,
- Stroke 150,153,156,165
- Summary Screen. 64
- Supervisor password. 79-80
- Support representative 10,27,45,78,102
118-119,134-136,138-140,144
- Suspend 5-6,11,19,21, 23,25-29,38-45
78,80,83-85,87,97, 102,104, 111-115,123
127-132,135-136,150,153-154,156-157,165
- Suspend mode 6,11,19, 23,26-29,38-40
42-44,83-85,87,97,102,104,111, 113-115,123,
127-128,130-131,135,150,153-154,156-157
- Suspend/Resume button . . 6,21,25,29,39 40
42,43,44,45,84,112,123,129,130,132,135,136
- SVGA. 9,149-150, 153,156, 158,165
- System battery 140
- System Clock 165
- System Date 56-57
- System error. 24, 113,115
- System memory 10,43-45,58,84,109-110
140,148,151,154,161
- System Time 56-57
- System timer 140

- Telephone** 4,8,14,26,84,95-96,106
110,114, 149,152, 156,158
- TFT** 3,153, 156,165
- Theft Prevention Lock.** 7, 95,106,151,154,157
- Tilt Adjustment Feet** 9-10
- Time** 1,12-14,24,26,28,31, 33,37-38
44,52-53, 56-57,82-83,85,98, 101-102,106
109,112-113,115,133-135,140,144,150
153,156-157, 159-160,164-165
- Touchpad.** 13,43
- Transfer Mode.** 62
- Troubleshooting** 4,54,111, 118-119,121
123,125,127,129,131,133,135,137,139,141
- Tutorials** 15
- TV** 162,165
- UL** 157,165
- Unauthorized access.** 11
- Universal Serial Bus.** 7,96,149,152,156
- USB** 4,7,95-96,105, 111,115
119,125-126,149,152,156,158
- USB Device.** 4,119,125
- USB Port.** 7,96,105
- User input** 82-83
- User Password** 79
- User Registration** 1,14
- Vehicle** 11
- VGA.** 9,149-150,152-153,156,158,165
- Video.** 3-4,33,41-43,45,47, 66,75-76
82,85-87,96,103, 106,119, 134-137,140
148-149,151-152,155,158,162,165
- Video Timeout** 42,45,82, 85,87,135
- Virus.** 4,13,47
- Voice functions** 46
- Volume Control** 7-8,17,29, 34,48,120
- VRAM** 165
- Windows** 2,4,6,12-15,19-20,22-26
32-33,38-40,42-44,46-47,52, 56,81,104-105
113-115,129, 145,149-150, 152-153,155-156
- Windows Setup** 138
- Windows Taskbar** 104
- Write protect.** 5,80,165
- XGA** 158,165
- Zoomed Video** 96, 103,149
152,155,158,165

Other ManualsLib Projects



www.manualslib.com



www.manualslib.de



www.manualslib.es



www.manualslib.fr



www.manualslib.nl



www.manualslib.mx



www.manualslib.tech 30+ Languages