

## COPYRIGHT

Fujitsu PC Corporation has made every effort to ensure the accuracy and completeness of this document. However, as ongoing development efforts are continually improving the capabilities of our products, we cannot guarantee the accuracy of the contents of this document. We disclaim liability for errors, omissions, or future changes.

Fujitsu and the Fujitsu logo are registered trademarks and LifeBook is a trademark of Fujitsu Limited.

Built for Humans and ErgoTrac are trademarks of Fujitsu PC Corporation.

The following are registered trademarks of IBM Corporation: IBM, IBM PC AT, IBM PS/2.

The following are registered trademarks of Microsoft Corporation: MS, MS-DOS, Windows 95. PCMCIA is a trademark of the Personal Computer Memory Card International Association.

Phoenix and the Phoenix logo are registered trademarks of Phoenix Technologies, Ltd.

Pentium is a registered trademark and MMX technology is a trademark of Intel Corporation.

PC-Doctor is a trademark of [watergate.software.inc](http://watergate.software.inc).

SoftPEG is a registered trademark of CompuCore Multimedia Inc.

LapLink is a registered trademark of Traveling Software Inc.

AudioRack is a registered trademark of ESS Technology, Inc.

MegaPhone is a registered trademark of AVEO, Inc.

All other trademarks mentioned herein are the property of their respective owners.

We cannot guarantee the accuracy of the contents of this document. We disclaim liability for errors, omissions, or future changes.

© Copyright 1998 Fujitsu PC Corporation. All rights reserved. No part of this publication may be copied, reproduced, or translated, without prior written consent of Fujitsu PC Corporation. No part of this publication may be stored or transmitted in any electronic form without the written consent of Fujitsu PC Corporation.



## DECLARATION OF CONFORMITY according to FCC Part 15

Responsible Party Name: Fujitsu PC Corporation

Address: 598 Gibraltar Drive  
Milpitas, CA 95035

Telephone: (408) 935-8800

Declares that product: Model: LifeBook 270Dx.  
LifeBook 280Dx.

Complies with Part 15  
of the FCC Rules.

This device complies with Part 15 of the FCC rules. Operations is subject to the following two conditions: (1) This device must not be allowed to cause harmful interference, (2) This device must accept any interference received, including interference that may cause undesired operation.

David Woo  
FULL NAME

Fujitsu  
COMPANY

4/20/98  
DATE



## CAUTION

Changes or modifications not expressly approved by Fujitsu PC Corporation could void this user's authority to operate the equipment.

### FCC NOTICES

#### Notice to Users of Radios and Television

These limits are designed to provide reasonable protection against harmful interference in a residential installation. This equipment generates, uses, and can radiate radio frequency energy and, if not installed and used in accordance with the instructions, may cause harmful interference to radio communications. However, there is no guarantee that interference will not occur in a particular installation. If this equipment does cause harmful interference to radio or television reception, which can be determined by turning the equipment off and on, the user is encouraged to try to correct the interference by one or more of the following measures:

- Reorient or relocate the receiving antenna.
- Increase the separation between the equipment and receiver.
- Connect the equipment into an outlet that is on a different circuit than the receiver.
- Consult the dealer or an experienced radio/TV technician for help.

Shielded interconnect cables must be employed with this equipment to ensure compliance with the pertinent RF emission limits governing this device.

Notice to Users of the US Telephone Network  
The LifeBook™ 200 Series notebook computers are supplied with an internal modem which complies with Part 68 of the FCC rules. On this notebook is a label that contains the FCC Registration Number and the Ringer Equivalence Number (REN) for this equipment among other information. If requested, the user must provide their telephone company with the following information:

1. The telephone number to which the notebook is connected.
2. The Ringer Equivalence Number (REN) for this equipment.
3. That the equipment requires a standard modular jack type USOC RJ-11C which is FCC Part 68 compliant.
4. The FCC Registration Number.

This equipment is designed to be connected to the telephone network or premises wiring using a standard modular jack type USOC RJ-11C which is FCC Part 68 compliant and a line cord between the modem and the telephone network with a minimum of 26AWG.

The REN is used to determine the number of devices that you may connect to your telephone line and still have all of those devices ring when your number is called. Too many devices on one line may result in failure to ring in response to an incoming call. In most, but not all, areas the sum of the RENs of all of the devices should not exceed five (5.0). To be certain of the number of devices you may connect to your line, as determined by the RENs, contact your local telephone company.

If this equipment causes harm to the telephone network, your telephone company may discontinue your service temporarily. If possible, they will notify you in advance. If advance notice is not practical they will notify you as soon as possible. You will also be advised of your right to file a complaint with the FCC.

This fax modem also complies with fax branding requirements per FCC Part 68.

Your telephone company will probably ask you to disconnect this equipment from the telephone network until the problem is corrected and you are sure that the equipment is not malfunctioning. This equipment may not be used on coin service telephones provided by your telephone company. Connection to party lines is subject to state tariffs. Contact your state's public utility commission, public service commission or corporation commission for more information.

This equipment includes automatic dialing capability. When programming and/or making test calls to emergency numbers:

- Remain on the line and briefly explain to the dispatcher the reason for the call.
- Perform such activities in off-peak hours, such as early morning or late evening.

FCC rules prohibit the use of non-hearing aid compatible telephones in the following locations or applications:

- All public or semipublic coin-operated or credit card telephones.
- Elevators, highways, tunnels (automobile, subway, railroad or pedestrian) where a person with impaired hearing might be isolated in an emergency.
- Places where telephones are specifically installed to alert emergency authorities such as fire, police or medical assistance personnel.
- Hospital rooms, residential health care facilities, convalescent homes and prisons.
- Workstations for the hearing impaired.
- Hotel, motel or apartment lobbies.
- Stores where telephones are used by patrons to order merchandise.

- Public transportation terminals where telephones are used to call taxis or to reserve lodging or rental cars.
- In hotel and motel rooms as at least ten percent of the rooms must contain hearing aid compatible telephones or jacks for plug-in hearing aid compatible telephones which will be provided to hearing impaired customers on request.

#### DOC (INDUSTRY CANADA) NOTICES

Notice to Users of Radios and Television  
This Class B digital apparatus meets all requirements of the Canadian Interference-Causing Equipment Regulations.

CET appareil numérique de la class B respecte toutes les exigences du Règlement sur le matériel brouilleur du Canada.

Notice to Users of the Canadian Telephone Network

The Canadian Industry Canada label identifies certified equipment. This certification means that the equipment meets certain telecommunications network protective, operational and safety requirements. The Department does not guarantee the equipment will operate to the user's satisfaction.

The LifeBook 200 Series notebook computers are supplied with an internal modem which complies with the Industry Canada certification standards for telecommunication network protection and safety requirements. Before connecting this equipment to a telephone line the user should ensure that it is permissible to connect this equipment to the local telecommunication facilities. The user should be aware that compliance with the certification standards does not prevent service degradation in some situations.

Repairs to telecommunication equipment should be made by a Canadian authorized maintenance facility. Any repairs or alterations not expressly approved by Fujitsu™ PC Corporation or any equipment failures may give the telecommunication company cause to request the user to disconnect the equipment from the telephone line.

The connecting arrangement code for this equipment is CA11A.

The Load Number is 3.

The Load Number assigned to each telephone terminal device denotes the percentage of the total load to be connected to a telephone loop or circuit which is used by the device to prevent overloading. The termination on a loop may consist of any combination of devices such that the total of the load numbers of all devices does not exceed 100.



## CAUTION

For safety, users should ensure that the electrical ground of the power utility, the telephone lines and the metallic water pipes are connected together. Users should NOT attempt to make such connections themselves but should contact the appropriate electric inspection authority or electrician. This may be particularly important in rural areas.

### Avis Aux Utilisateurs Du Réseau

Téléphonique Canadien

L'étiquette canadienne Industrie Canada identifie l'équipement certifié. Cette certification signifie que l'équipement satisfait certaines normes de protection, d'exploitation et de sécurité des réseaux de télécommunications. Le département ne garantit pas le fonctionnement de l'équipement à la satisfaction de l'utilisateur.

La série LifeBook 200 possède un modem interne conforme aux normes de certification d'Industrie Canada pour protéger les réseaux de télécommunications et satisfaire aux normes de sécurité. Avant de connecter cet équipement à une ligne téléphonique, l'utilisateur doit vérifier s'il est permis de connecter cet équipement aux installations de télécommunications locales. L'utilisateur est averti que même la conformité aux normes de certification ne peut dans certains cas empêcher la dégradation du service.

Les réparations de l'équipement de télécommunications doivent être effectuées par un service de maintenance agréé au Canada. Toute réparation ou modification, qui n'est pas expressément approuvée par Fujitsu PC Corp.,

ou toute défaillance de l'équipement peut entraîner la compagnie de télécommunications à exiger que l'utilisateur déconnecte l'équipement de la ligne téléphonique.

Le code d'arrangement de connexion de cet équipement est CA11A.

Le numéro de charge est 3.

Le numéro de charge assigné à chaque terminal téléphonique indique le pourcentage de la charge totale pouvant être connecté à une boucle ou à un circuit téléphonique, utilisé par ce périphérique afin de prévenir toute surcharge. La terminaison d'une boucle peut être constituée de n'importe quelle combinaison de périphériques de sorte que le total de numéros de charge de tous les périphériques n'excède pas 100.



#### **AVERTISSEMENT**

Pour assurer la sécurité, les utilisateurs doivent vérifier que la prise de terre du service d'électricité, les lignes téléphoniques et les conduites d'eau métalliques sont connectées ensemble. Les utilisateurs NE doivent PAS tenter d'établir ces connexions eux-mêmes, mais doivent contacter les services d'inspection d'installations électriques appropriés ou un électricien. Ceci peut être particulièrement important en régions rurales.

#### **UL NOTICE (FOR AUTHORIZED REPAIR TECHNICIANS ONLY)**

**CAUTION:** For continued protection against risk of fire, replace only with the same type and rating fuse.

**CAUTION:** Danger of explosion if CMOS battery is incorrectly replaced. Replace only with the same or equivalent type recommended by the manufacturer. Dispose of used batteries according to the manufacturer's instruction.

**WARNING:** CMOS and NiCAD batteries may explode if mistreated. Do not recharge, disassemble or dispose of in fire.

## Table of Contents

---

<b>PREFACE</b> . . . . .	vi	<b>SECTION TWO</b>		<b>SECTION THREE</b>	
<b>SECTION ONE</b>		<b>USING YOUR LIFEBOOK 200 SERIES</b>		<b>CONFIGURING YOUR LIFEBOOK 200</b>	
<b>SETTING UP YOUR LIFEBOOK 200</b>		<b>FROM FUJITSU</b>		<b>SERIES FROM FUJITSU</b>	
<b>SERIES FROM FUJITSU</b>		<b>Display Panel</b> . . . . .	18	<b>Boot Sequence</b> . . . . .	52
<b>Unpacking</b> . . . . .	2	<b>Adjusting the Keyboard Angle</b> . . . . .	19	<b>Identifying the Drives</b> . . . . .	52
<b>Overview of LifeBook 200 Series Features</b> . . . . .	3	<b>Status Indicator Panel</b> . . . . .	19	<b>BIOS Setup Utility</b> . . . . .	53
<b>Component Identification</b> . . . . .	5	<b>Power On</b> . . . . .	23	<b>Navigating Through the Setup Utility</b> . . . . .	55
<b>Top and Front Components</b> . . . . .	6	<b>Power Off</b> . . . . .	24	<b>Main Menu – Setting Standard</b>	
<b>Left-side Panel Components</b> . . . . .	7	<b>Restarting The System</b> . . . . .	25	<b>System Parameters</b> . . . . .	56
<b>Right-side Panel Components</b> . . . . .	8	<b>Batteries</b> . . . . .	26	<b>Advanced Menu – Setting Device</b>	
<b>Rear Panel Components</b> . . . . .	9	<b>Fujitsu Welcome Center</b> . . . . .	26	<b>Feature Controls</b> . . . . .	65
<b>Bottom Components</b> . . . . .	10	<b>Integrated ErgoTrac™ Pointing Device</b> . . . . .	30	<b>Security Menu – Setting the</b>	
<b>Power Sources</b> . . . . .	11	<b>Using The Keyboard</b> . . . . .	32	<b>Security Features</b> . . . . .	87
<b>Data Security</b> . . . . .	12	<b>Volume Control</b> . . . . .	34	<b>Power Menu – Setting Power</b>	
<b>Starting Your Notebook for the First Time</b> . . . . .	13	<b>Floppy Disk Drive</b> . . . . .	34	<b>Management Feature Controls</b> . . . . .	93
<b>User Registration</b> . . . . .	15	<b>CD-ROM Drive</b> . . . . .	36	<b>Boot Menu – Selecting the</b>	
<b>Learning About Your Operating System</b>		<b>Iomega Zip Drive</b> . . . . .	38	<b>Operating System Source</b> . . . . .	101
<b>and Application Software</b> . . . . .	15	<b>Hard Drive</b> . . . . .	39	<b>Info Menu – Displaying Basic</b>	
		<b>Power Management</b> . . . . .	40	<b>System Information</b> . . . . .	105
		<b>Internal Modem</b> . . . . .	48	<b>Exit Menu – Leaving the Setup Utility</b> . . . . .	107
		<b>Infrared Port</b> . . . . .	48	<b>Setting Up Your Save-to-Disk</b>	
		<b>Pre-Installed Software</b> . . . . .	49	<b>File Allocation</b> . . . . .	110

## Table of Contents

### SECTION FOUR USER INSTALLABLE FEATURES

Multi-function Bay Devices . . . . .	115
PC Cards . . . . .	121
Parallel Port Devices . . . . .	124
Serial Port Devices . . . . .	124
USB Devices . . . . .	124
Microphone . . . . .	124
Stereo Line In Devices . . . . .	124
Headphones . . . . .	124
Telephone Lines . . . . .	124
Mouse or Keyboard . . . . .	125
External Monitor . . . . .	125
Theft Prevention Lock . . . . .	125
External Installation of a Floppy Disk Drive . . . . .	125
Memory Upgrade Module . . . . .	126
LANdock . . . . .	130
Port Replicator . . . . .	134

### SECTION FIVE TROUBLESHOOTING

Identifying the Problem . . . . .	138
Specific Problems . . . . .	139
Power On Self Test Messages . . . . .	159
Emergency CD-ROM Drive Tray Release . . . . .	162
Emergency Zip Disk Release . . . . .	162
Modem Setup and Commands . . . . .	162
Restoring Your Pre-Installed Software From CD-ROM . . . . .	163

### SECTION SIX CARE AND MAINTENANCE

Care and Maintenance . . . . .	166
Caring for your Notebook . . . . .	166
Increasing Battery Life . . . . .	167
Caring for Your Batteries . . . . .	167

### APPENDIX A SPECIFICATIONS

Warranty . . . . .	170
LifeBook 270Dx Specifications . . . . .	170
LifeBook 280Dx Specifications . . . . .	173
Approvals . . . . .	178
Popular Accessories . . . . .	178

### APPENDIX B GLOSSARY

Glossary . . . . .	179
--------------------	-----

### INDEX

Index . . . . .	187
-----------------	-----



## PREFACE

The LifeBook 200 Series from Fujitsu PC Corporation is a powerful notebook computer. It is powered by an Intel Pentium® microprocessor with MMX™ technology, has a built-in DSTN color display, a modular CD-ROM drive, a modular Iomega Zip® Drive removable media drive, and brings the computing power of desktop personal computers (PCs) to a portable environment.

This manual explains how to operate your LifeBook 200 Series' hardware and built-in system software. The LifeBook 200 Series is compatible with the IBM® PC AT. It comes with Windows 95 pre-installed.

A LifeBook 200 Series notebook is a completely self-contained unit with a dual-scan (DSTN) color LCD display. It has a powerful interface that enables it to support a variety of optional features. (Figure P-1.)

## CONVENTIONS USED IN THE GUIDE

Screen examples in this manual are intended as examples only, and screen and file names may differ in actual use.

Messages displayed by the LifeBook 200 Series appear in Courier type.

Example: Shutdown the computer?

Keyboard keys are shown in boldface Helvetica type.

Example: Fn, F1, Esc, and Ctrl.

Pages with additional information about a specific topic are cross-referenced within the text.

Example: (See page xx.)



### POINT

The point icon highlights information that will enhance your understanding of the subject material.



### CAUTION

The caution icon highlights information that is important to your safety, to the safe operation of your computer, or to the integrity of your files. Please read all caution information carefully.

**LifeBook 200 Series from Fujitsu**

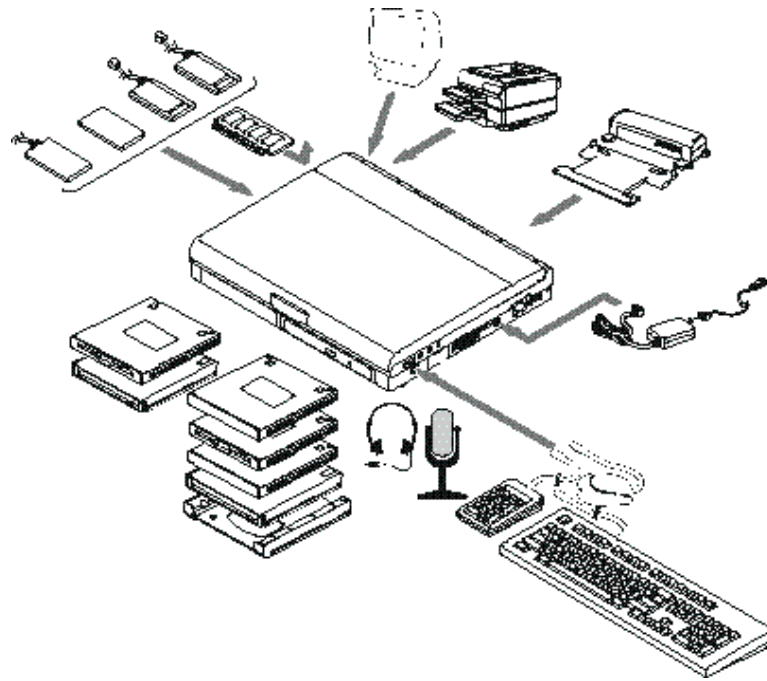


Figure P-1 LifeBook 200 Series  
with Both Fujitsu and  
Third Party Options

**Setting Up Your LifeBook 200 Series**

Unpacking . . . . .	2
Overview of LifeBook 200 Series Features . . . . .	3
Component Identification . . . . .	5
Top and Front Components . . . . .	6
Left-side Panel Components . . . . .	7
Right-side Panel Components . . . . .	8
Rear Panel Components . . . . .	9
Bottom Components . . . . .	10
Power Sources . . . . .	11
Data Security . . . . .	12
Starting Your Notebook for the First Time . . . . .	13
User Registration . . . . .	15
Learning About Your Operating System and Application Software. . . . .	15

## Section One

### SETTING UP YOUR LIFEBOOK 200 SERIES FROM FUJITSU

This section describes how to set up your LifeBook 200 Series from Fujitsu. We strongly recommend that you read it before using your notebook – even if you are already familiar with notebook computers.

#### UNPACKING

When you receive your notebook, unpack it carefully, and compare the parts you have received with the items listed below.

For a standard configuration you should have:

- LifeBook 200 Series notebook from Fujitsu. (Figure 1-1.)
- AC adapter with AC power cord (located in the Accessories box). (Figure 1-2.)
- Modular Lithium ion battery. (Already installed in Multi-function Bay 1 of your notebook.)
- Modular 20-speed maximum CD-ROM drive. (Already installed in Multi-function Bay 2 of your notebook.)
- Modular 100Mb Iomega Zip removable media drive (located in the Accessories box). (Figure 1-3.)
- Bay Adapter for Multi-function Bay 2 (located in the Accessories box). (Figure 1-4.)
- Modular 3.5" floppy disk drive (located in the Accessories box). (Figure 1-5.)
- RJ-11 cable (located in the Accessories box).
- Getting Started Guide.
- User's Guide.
- Microsoft Windows Manual.
- Registration card and customer information pack.
- Recovery CD-ROM (located in the Accessories box).
- Additional equipment and/or documentation.

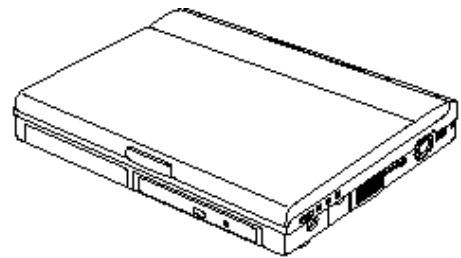


Figure 1-1 LifeBook 200 Series Notebook

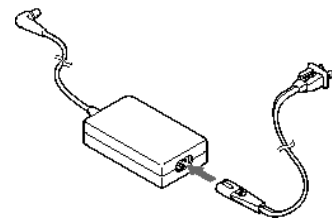


Figure 1-2 AC Adapter Unit

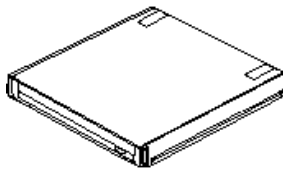
**Setting Up Your LifeBook 200 Series**

Figure 1-3 Iomega Zip Drive

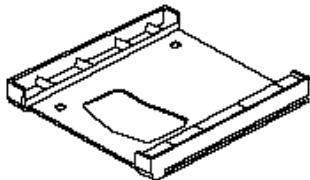


Figure 1-4 Bay Adapter for Multi-function Bay 2

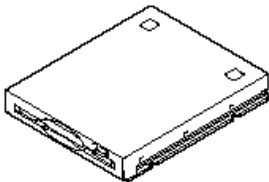


Figure 1-5 Floppy Disk Drive

Once you have checked and confirmed that your notebook system is complete, connect the AC adapter and follow the instructions on pages 12-14 to accept the conditions for using the LifeBook 200 Series notebook. When you have completed the Conditions of Use process please register your notebook. (See page 14.)

#### OVERVIEW OF LIFEBOOK 200 SERIES FEATURES

The LifeBook 200 Series is a compact, yet powerful notebook computer available with standard features including: (See Appendix A, pages 150-163, for detailed information on individual models.)

- 200MHz or 233MHz Intel Pentium processor with MMX technology.
- 32MB SDRAM standard, expandable to 96MB.
- 12.1" HPA dual-scan (DSTN) color display with 800 x 600 resolution.
- 2MB EDO video RAM.
- Built-in 2.1GB or 3.2GB hard drive.

- Dual Multi-function bays which support the following:
  - 3.5" floppy disk drive (included with all models).
  - 20-speed maximum CD-ROM drive (included with all models) (for Bay 2 only).
  - 100MB Iomega Zip drive (included with all models).
  - Optional second 3.2GB hard drive (for Bay 2 only).
  - Lithium ion battery (one included with all models).
  - Optional second Lithium ion battery.
- Internal 56K fax/data/voice modem with built-in telephony and DSVD support, upgradable to v.90.



#### CAUTION

Your internal modem is designed to allow faster downloads from K56flex compliant digital sources. Maximum achievable download transmission rates may not reach 56kbps and will vary with line conditions.

**CAUTION**

The internal modem is not intended for use with Digital PBX systems. Do not connect the internal modem to a digital PBX as it may cause serious damage to the internal modem or your entire notebook. Consult your PBX manufacturer's documentation for details. Some hotels have Digital PBX systems. Be sure to find out BEFORE you connect your modem.

- **Full audio and video features:**
  - 16-bit SoundBlaster-compatible sound chip.
  - 3D-Stereo for multiple speaker effect.
  - Zoomed Video support for full motion video acceleration.
  - Built-in stereo speakers.
  - Built-in mono microphone.
  - Stereo line in jack.
  - Stereo headphone jack.
  - Microphone jack.
- Two Type II/one Type III PC Card slots.
- Fast IrDA (4Mbps) compatible infrared port for wireless data transfer.
- Integrated ErgoTrac™ pointing device for superb cursor control and comfort.
- External monitor support with simultaneous display capabilities.
- Full-size keyboard with three dedicated Windows 95 keys.
- Hot swappable PS/2 port for external components.
- USB device support.
- Bridge battery allowing warm-swapping of Lithium ion batteries.
- Standard pre-installed software:
  - Microsoft Windows 95 operating system.
  - LapLink for file transfers via modem, cable or infrared port.
  - Microsoft Works for business applications including word processing, spreadsheets and databases.
- Quicken Basic 98 for money management.
- PC-Doctor for system diagnostics.
- Phoenix PowerPanel for system power management.
- SoftPEG from CompCore, an MPEG-1 video player.
- McAfee VirusScan for virus protection.
- ESS AudioRack for 3D-Stereo, audio CD and other audio controls.
- Iomega Tools software for managing and using the Zip drive.
- MegaPhone for telephone applications including fax, dialing, and speakerphone.
- Standard user install software:
  - JFax Personnel Telecom®.
  - Internet Explorer®.
  - AOL Free Trial.
  - AT&T WorldNet™.
  - Netscape® Communicator.

### Setting Up Your LifeBook 200 Series

#### COMPONENT IDENTIFICATION

For detailed specifications on each model refer to Appendix A on pages 150-163.

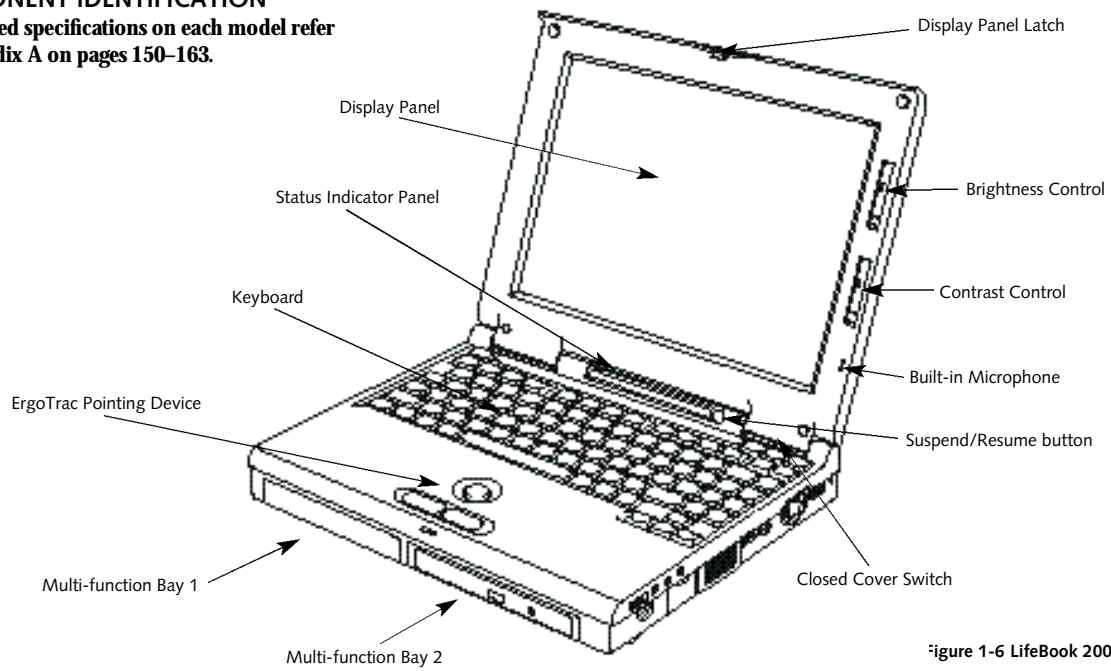


Figure 1-6 LifeBook 200 Series with Display Open

## TOP AND FRONT COMPONENTS

### Display Panel Latch

This latch locks and releases the display panel. When the display panel is released it pops up slightly to make it easier to open. (Figure 1-6.)

### Display Panel

This is a color LCD panel with back lighting for the display of text and graphics. (Figure 1-6.)

### Brightness Control

The brightness control adjusts the overall intensity of the display panel back lighting. (Figure 1-6.)

### Contrast Control

The contrast control (located just below the brightness control) sets the ratio of the intensity of the light to dark areas of the display. (Figure 1-6.)

### Built-in Microphone

The built-in microphone allows mono audio input to your notebook. (Figure 1-6.)

### Status Indicator Panel

An LCD display of the status of the power state and source, Suspend mode, battery charge (battery in either Multi-function Bay), floppy disk drive activity, hard drive or Zip drive activity, CD-ROM drive activity, PC Card activity, CapsLock, NumLk and Scr Lk. (Figure 1-6.)

### Suspend/Resume Button

The Suspend/Resume button allows you to suspend notebook activity without turning off the notebook power, and to return it to an active state. This feature saves power, and is particularly useful when the notebook is running only on battery power. (See pages 38-46 and 81-87 for more information on power management.) (Figure 1-6.)



## CAUTION

Be sure you know which settings are active for your Suspend/Resume button before you use it because misuse can result in data loss. (See the Power Savings Menu of the BIOS setup utility, pages 81-87, for more information.)

### Closed Cover Switch

The closed cover switch turns off the LCD back lighting when the display panel is closed, thus saving power. This switch also behaves as a Suspend/Resume button. To change the functionality of this switch, adjust the settings in the Advanced Features submenu of the Power menu in the BIOS Setup Utility. (See pages 93-100.) (Figure 1-6.)

## Setting Up Your LifeBook 200 Series

### Keyboard

A full-size keyboard with dedicated Windows 95 keys for input into the notebook.  
(Figure 1-6.)

### ErgoTrac Pointing Device

The integrated ErgoTrac pointing device is composed of a short, comfortable, dish-shaped finger mouse and two buttons. Its button-like shape is both responsive and comfortable for your finger when rocked gently. (Figure 1-6.)

### Multi-function Bay One

This bay accommodates:

- Lithium ion battery.
- 3.5" floppy disk drive.
- 100MB Zip removable media drive.

### Multi-function Bay Two

This bay accommodates:

- 20-speed maximum CD-ROM drive.
- 100MB Zip removable media drive mounted in the Bay Adapter for Multi-function Bay 2.
- Lithium ion battery mounted in the Bay Adapter for Multi-function Bay 2 (a second battery can be purchased separately for a dual battery configuration).
- Optional second 3.2GB hard drive (which must be purchased separately).
- 3.5" floppy disk drive mounted in the Bay Adapter for Multi-function Bay 2.



### CAUTION

Do not use your notebook with either of the Multi-function bays empty. It may damage your notebook.

### LEFT-SIDE PANEL COMPONENTS

#### PC Card Slots

The PC Card Slots allow you to install two Type I or Type II PC Cards or one Type III PC Card. (See pages 103-105 for more information on PC Cards.) The button to the left of the card slots locks the card(s) in place, and the buttons to the right of the slots eject the card(s) from the slots. (Figure 1-7.)

#### Left Speaker

The built-in dual speakers output stereo sound from the notebook.  
(Figure 1-7 and Figure 1-8.)

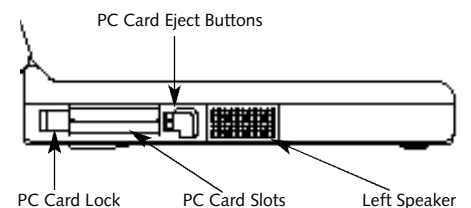


Figure 1-7 LifeBook 200 Series Left-side Panel

### RIGHT-SIDE PANEL COMPONENTS

#### Theft Prevention Lock Slot

This is a slot that allows you to attach a physical lock down device. (Figure 1-8.)

#### USB Port

This port allows you to connect Universal Serial Bus devices, such as external game pads, pointing devices, keyboards and speakers. (Figure 1-8.)

#### DC Power Jack

The DC power jack allows you to plug in the AC adapter or the optional auto/airline adapter. (Figure 1-8.)

#### Power Switch

This switch is the main power switch for your notebook. (Figure 1-8.)

#### Right Speaker

The built-in dual speakers output stereo sound from the notebook. (Figure 1-7 and Figure 1-8.)

#### External Floppy Disk Drive Port

A port for attaching an optional external floppy disk drive. This allows you to connect an optional separate floppy disk drive when the Multi-function bays are being used for other purposes. (Figure 1-8.)

#### PS/2 Port

The port allows you to connect an external PS/2 keyboard, mouse, or numeric keypad. (Figure 1-8.)

#### Microphone Jack

The microphone jack allows you to connect an external mono microphone. (Figure 1-8.)

#### Stereo Line In Jack

The stereo line in jack allows you to connect an external audio source to your notebook, like an audio cassette player. This jack will not support an external microphone. (Figure 1-8.)

#### Headphone Jack

You can connect headphones or powered external speakers to the headphone jack. (Figure 1-8.)

#### Volume Control

The volume control is a knob which provides manual control of the sound level of all audio output from your notebook. (Figure 1-8.)

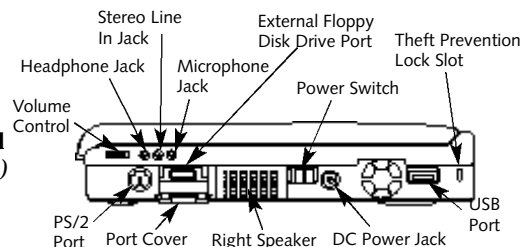


Figure 1-8 LifeBook 200 Series Right-side Panel

### CAUTION

There are also software volume controls. The knob setting and the software settings will interact. Be sure to check both the software volume control and the knob on your notebook if you are experiencing problems. (See *Volume Control* on page 34 for more information.)

**REAR PANEL COMPONENTS****RJ-11 Jack**

This is the jack for attaching a telephone line to the internal modem. This jack can be used with the connector cover closed and the sliding panel in the connector cover slightly opened for added convenience. (Figure 1-9.)

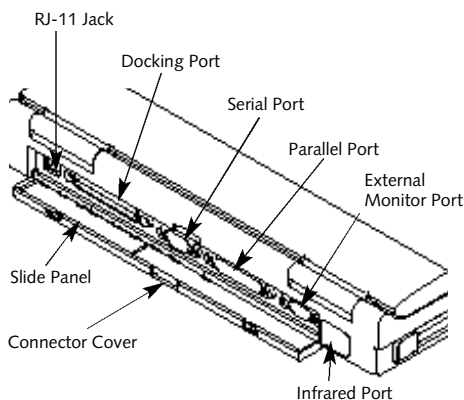


Figure 1-9 LifeBook 200 Series Rear Panel

**CAUTION**

The internal modem is not intended for use with Digital PBX systems. Do not connect the internal modem to a digital PBX as it may cause serious damage to the internal modem or your entire notebook. Consult your PBX manufacturer's documentation for details. Some hotels have Digital PBX systems. Be sure to find out BEFORE you connect your modem.

**Docking Port**

This port is for connection to an optional port replicator or docking station. The connector cover must be closed and the sliding panel fully opened to reveal the docking port and the RJ-11 jack when connecting a port replicator or a docking station. (Figure 1-9.)

**CAUTION**

The cover – which closes over the ports on the rear of the notebook – can be damaged if it is left open when the notebook is moved around.

**Serial Port**

The serial port allows you to connect serial RS-232C devices, such as serial printers or serial scanners. (This is also sometimes referred to as a COM port.) (Figure 1-9.)

**Parallel Port**

The parallel port allows you to connect parallel devices, such as a parallel printer to your notebook. (This is also sometimes referred to as an LPT port.) (Figure 1-9.)

**External Monitor Port**

This port allows you to connect an external VGA or SVGA CRT monitor. (Figure 1-9.)

**Infrared Port**

The fast IrDA (4Mbps) compatible port allows you to communicate with another IrDA compatible infrared device without a cable. (See pages 46-47 for more information.) (Figure 1-9.)

**BOTTOM COMPONENTS**

**Tilt Adjustment Feet**

These are a pair of feet which flip down and hold the back of the notebook approximately 6° higher than the front when resting on a flat surface. They are designed to make using your notebook keyboard more comfortable. (Figure 1-10.)

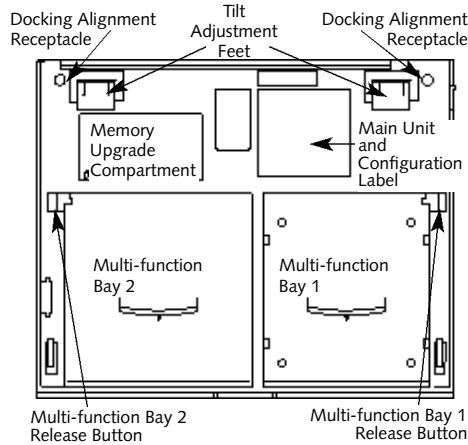


Figure 1-10 LifeBook 200 Series Bottom

**Main Unit and Configuration Label**

This label shows the model number and other information about your notebook. In addition the configuration portion of the label has the serial number and manufacturer information that you will need to give your support representative so that he or she can help you. It identifies the exact version of various components of your notebook. (Figure 1-10.)

**Memory Upgrade Compartment**

This compartment houses the memory upgrade module which allows you to expand the system memory capacity of your notebook. (See pages 108-110 for more information on installing added memory capacity.) (Figure 1-10.)

**Multi-function Bay 1 Release Button**

This is the release to allow removal and installation of devices in Multi-function Bay 1. (Figure 1-10.)

**Multi-function Bay 1**

This compartment is accessed from the front of your notebook. (See Figure 1-6 on page 5.)

## Setting Up Your LifeBook 200 Series

**Multi-function Bay 2 Release Button**  
This is the release to allow removal and installation of devices in Multi-function Bay 2.  
(Figure 1-10.)

**Multi-function Bay 2**  
This compartment is accessed from the front of your notebook. (See Figure 1-6 on page 5.)

#### POWER SOURCES

Your notebook has four possible power sources: the primary Lithium ion battery; an optional dual Lithium ion battery configuration; the AC adapter; or an optional auto/airline adapter.

**Connecting the Power Adapters**  
The AC adapter or an optional auto/airline adapter provides power for operating your notebook and charging the batteries.  
(Figure 1-11.)

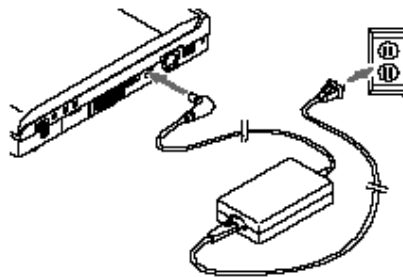


Figure 1-11 Connecting the AC Adapter

To Connect the AC Adapter

1. Plug the DC Output cable of the AC adapter into the DC Power jack on the right side panel of your notebook.
2. Plug the AC adapter into an AC electrical outlet.

To Connect the Optional Auto/airline Adapter

1. Plug the DC Output cable into the DC Power jack on the right side panel of your notebook.

2. Plug the auto/airline adapter plug into the cigarette lighter of a car or other vehicle with the ignition key in the On or the Accessories position or into the DC Power jack on an airplane seat.

To Switch From AC Adapter Power  
To Battery Power

1. Be sure that you have at least one charged battery installed.
2. Remove the AC or auto/airline adapter.



### CAUTION

The primary Lithium ion battery is not charged when you purchase your notebook. Initially you will need to connect the AC adapter or the auto/airline adapter to use it. If you purchase a second Lithium ion battery it will not be charged when you get it. You will need to charge it prior to use. It can take up to three (3) hours to charge a single battery if your notebook is turned off or is in Suspend mode. If your notebook is in use it can take up to nine (9) hours or more to charge a single battery.

### DATA SECURITY

**Your LifeBook 200 Series has a built-in hardware control password security feature that allows you to protect the data stored in the notebook from unauthorized access. Your operating system and some applications have**

**software control password security features that allow you to protect all or portions of the data stored in the notebook from unauthorized access.**

#### Hardware Data Security Features

**When you are using your notebook built-in hardware control password to gain access to the notebook the actual password will not appear on the screen. This is a safety precaution. The hardware control security parameters are set from the BIOS setup utility. (See Security Menu on pages 77-80 for more information on setting and clearing passwords and enabling and disabling built-in security features.)**

#### Software Data Security Features

**The operating system and some applications have security features that are independent of the built-in hardware protection features that are controlled from the BIOS. See your software documentation for more information about these features.**



### CAUTION

Make sure you memorize your passwords, both hardware and software. If you forget, you may not be able to use the notebook, and you will have to contact your service provider and arrange to have them reset the hardware system password. See your software documentation for what to do if you forget your software security password(s).



### CAUTION

Software security feature passwords may not be the same as the hardware security passwords. Be sure you know which features are controlled from software and which from hardware or you may lock yourself out of your own data or lock up your hardware and not be able to operate your notebook.

## STARTING YOUR NOTEBOOK FOR THE FIRST TIME

### Booting the System

The first time that you turn on your notebook you will need to attach your AC adapter because the battery is not charged when you get your machine. We strongly recommend that you not attach any other external devices and do not put any CDs or floppy disks in your drives until you have gone through the initial power on sequence.

When you turn on your notebook for the first time it will display a Fujitsu logo on the screen. If you do nothing the system will read the hard drive for the operating system software, flash the notebook configuration information on the screen, and then the Windows 95 Setup Wizard Screen will appear. (See *Power On* on pages 23-24 for additional help.) You will then be stepped through the condition of use process. You must complete this initial process before you will be able to use your notebook. (If you wish to access the BIOS setup utility before you go through the condition of use process you must

press the F2 key while the Fujitsu logo is still visible. If you press the Esc key while the Fujitsu logo is still present you will get a dialog box which will allow you to select which drive is to be used for finding the operating system.) If you turn off the power without using the on screen Cancel button you will get an error message when you start your notebook again.

### Conditions of Use Process

The first time you start your notebook you must confirm your acceptance of the copyright limitations for your pre-installed software. After you complete the Condition of Use process these screens will not appear again. There are 6 screens to read carefully and respond to.

You cannot use your notebook until this Condition of Use process is completed. The bottom of each screen has a <Back button, a Next> button and a Cancel button which are activated by the integrated ErgoTrac cursor control and button click. The <Back button will return you to the previous screen. The

Next> button activates any choices or information you have entered and takes you on to the next screen. The Cancel button allows you to stop the setup process.

If you stop the process your notebook will start up at the beginning of the Windows 95 Setup Wizard.

The screens you will be required to respond to are described with the required action.

### User Information

Fill in your name and your company name as you want the software licensed. To step from the name blank to the company blank press the Tab key. When the information has been entered click on the Next> button. You will not be allowed to continue until you make an entry.

### License Agreement

Read the agreement carefully. You can scroll through the text using the integrated ErgoTrac pointing device to activate the scroll bar or use the up arrow ↑ and down arrow ↓ keys to move up and down the text one line at a time,

or use the Page Up and Page Down keys to move the text one screen at a time. When you finish reading you must point and click to accept or reject the terms of the agreement and then click on the **Next>** button.



#### POINT

If you reject the terms of the license agreement you will be asked to review the license agreement for information on returning Windows 95 or to shut down your notebook.

#### Certificate of Authenticity

Look in the box that your notebook came in and you will find a Windows 95 Certificate of Authenticity shrink wrapped with the Windows 95 Users manual. On the certificate you will find a bar-code with a number above it. This is your product code and the number you should enter on the Certificate of Authenticity screen. When you have entered the number exactly as shown then click on the **Next>** button.

#### Start Wizard

The Start Wizard screen will appear if you have entered a valid product code. When you click on the **Finish** button the display will flash various screens as the system identifies what hardware is installed and runs a virus check.

#### Time Zone

When your notebook has completely identified all of the installed hardware it will display a dialog box for entering which time zone you wish to set the clock to.

#### Windows Messaging

Once you have selected a time zone you will see a screen announcing that Windows messaging is being set up.

#### Printer Setup

When the messaging setup is complete a dialog box will appear for selecting which printer is to be attached to your notebook. You do not have to select a printer at this time. If you do not wish to select a printer, click on the **Cancel** button. If you do wish to select a printer click on the **Next** button and answer the questions.

#### Windows 95 Setup

Once you have completed the printer setup or chosen not to set up a printer at this time, you will see the Windows 95 setup screen. This screen lets you set up Internet Explorer 4.01 with Active Desktop on your Lifebook. Follow the on-screen directions to complete installation of Internet Explorer 4.01.



#### POINT

If you would like to skip the installation of Internet Explorer 4.01, go to the Start Menu on the desktop, select Shutdown and restart the computer. After returning to Windows you can install Internet Explorer 4.01 anytime by selecting the icon, setup for Internet Explorer 4.0, in the Internet Starts Here folder on the desktop or in the Internet Software folder in the start menu.

**POINT**

You will find a Recovery CD-ROM packet in your accessories box. Please store the packet in a safe place in case there is a loss of data and it becomes necessary to re-install your operating system and/or application programs. (See *Restoring Your Pre-installed Software from the Recovery CD-ROM* on page 141.)

**REGISTERING YOUR LIFEBOOK**

What are the benefits of registering? You will receive an identification label for your LifeBook, which, if your LifeBook is ever lost, may help in getting it returned to you. You also receive priority Personal Identification Number (PIN) technical support access and useful product mailings. Proof of purchase is not required if you register within 30 days of your purchase.

**How do I register?**

By modem, fax, mail or telephone. To register your system by modem, with your system up and running, click on the Fujitsu Welcome Center Icon. Complete the electronic form and click on the "send registration" button. Your registration information will be transmitted via phone lines to the Fujitsu Registration Center and you will receive registration confirmation in one week to 10 days. You may also print your completed registration form and fax it to 1-714-450-9140 or mail it to:

Fujitsu PC Corporation  
15355 Barranca Pkwy, Irvine, CA 92618-9520

Alternately you may call:  
1-800-8fujitsu (1-800-838-5487)

**LEARNING ABOUT YOUR OPERATING SYSTEM AND APPLICATION SOFTWARE Tutorials**

All operating systems and most application software have tutorials built-in. We highly recommend that you step through your tutorial before you use an application even if you are familiar with the same application on a different machine, an earlier version of the application, or a similar product.

**Manuals**

In the accessories box you will find manuals for Windows 95 and other pre-installed software.

Software manuals of pre-installed software that are not in the accessories box are available online. See the help screens of your pre-installed software. We recommend that you review these manuals for general information on the use of these applications and to get a basic understanding of what is covered in the manual, and how it is organized, should questions arise as you use the applications.

**Using Your LifeBook 200 Series from Fujitsu**

Display Panel . . . . .	18
Adjusting the Keyboard Angle . . . . .	19
Status Indicator Panel. . . . .	19
Power On . . . . .	23
Power Off . . . . .	24
Restarting the System . . . . .	25
Fujitsu Welcome Center . . . . .	26
Batteries . . . . .	26
Integrated ErgoTrac Pointing Device . . . . .	30
Using the Keyboard. . . . .	32
Volume Control. . . . .	34
Floppy Disk Drive . . . . .	34
CD-ROM Drive. . . . .	36
lomega Zip Drive . . . . .	38
Hard Drive . . . . .	39
Power Management . . . . .	40
Internal Modem . . . . .	48
Infrared Port . . . . .	48
Pre-installed Software . . . . .	49

## SECTION TWO

### USING YOUR LIFEBOOK 200 SERIES FROM FUJITSU

This section describes the indicators, buttons, connections and operating modes of your LifeBook 200 Series and their uses.

#### DISPLAY PANEL

##### Opening the Display Panel

Lifting the latch releases the top of the display panel from the front of the notebook body. When the display panel is released it pops up slightly to make it easier to open. Lift the display panel backward until the screen is at a comfortable viewing angle. (Figure 2-1.)

##### Adjusting the Display Panel

When you turn on your notebook, you may want to adjust the brightness level of the screen for best visibility. To do this, adjust the brightness control slider on the right side of the display panel. (Figure 2-2.) You may need to adjust the brightness periodically for different

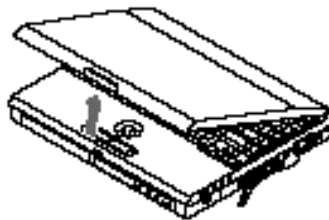


Figure 2-1 Opening the Display Panel

operating environments. You may also adjust contrast with a contrast control slider that is just below the brightness control.



#### POINT

The higher the brightness level, the more power the notebook will consume and the faster your batteries will discharge. For maximum battery life, make sure that the brightness is set as low as possible.

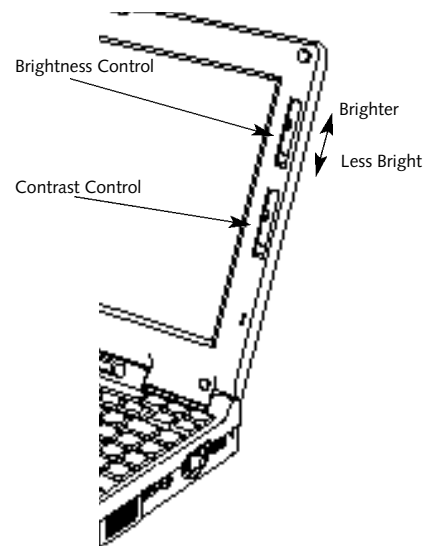


Figure 2-2 Display Adjustments

**ADJUSTING THE KEYBOARD ANGLE**

On the bottom of your notebook, near the back, are a pair of feet which flip down and hold the back of the notebook about 6° higher than the front when resting on a flat surface. They are designed to make it more comfortable to use the keyboard with your notebook. The feet must be folded flat against the bottom of the notebook when opening or using the CD-ROM drive or it will not open or operate properly. (Figure 1-10 on page 9)

**CAUTION**

Do not operate your CD-ROM drive or attempt to open the tray unless your notebook is sitting on a flat surface and the adjustment feet are folded against the bottom of the notebook. Using a CD-ROM drive when it is not level may damage the drive or prevent proper operation.

**CAUTION**

When you are not using the adjustment feet be sure that they are folded flat against the bottom of the notebook. They could be broken off or injure someone if not used properly.

**STATUS INDICATOR PANEL**

The Status Indicator panel is located in the recess just above the keyboard. (Figure 2-3.) The appropriate indicators become visible as you use your notebook.

**Power Indicator**

The Power indicator tells you when the system is operational. It is on steady when there is power to your notebook, and blinks when the system is in Suspend mode. It goes off when the system has entered Save-to-Disk mode, has entered the Windows 95 pseudo-off state, or the power is turned off from the power switch.

**POINT**

When your notebook has been shut down from Windows 95, it is not the same as turned off from the power switch. It is in a pseudo-off state, with all applications closed, but can be turned on by pressing the Suspend/Resume button. It is drawing some current in the pseudo-off state.

**CAUTION**

Your notebook's power switch must be turned off to prevent all current draw.

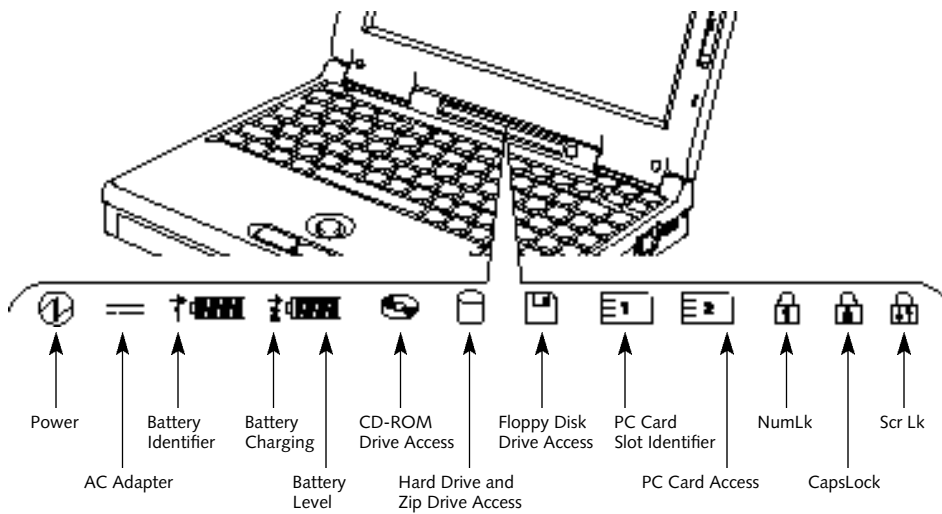


Figure 2-3 Status Indicator Panel

### AC Adapter Indicator

The AC Adapter indicator tells you whether the system is operating on an AC or auto/airline adapter, or batteries alone. The indicator is On when either of the adapters is active and Off when power comes from the batteries alone. If a battery is charging, the Power Adapter indicator is active regardless of the setting of the power switch. The AC Adapter indicator is also active in the Windows 95 pseudo-off state, regardless of the battery status. If there is no battery charging, and the power switch is Off, then the AC Adapter indicator and the Battery indicators will all be Off.

### Battery Indicators

The two sets of battery indicators show whether or not the primary Lithium ion battery and/or the optional second Lithium ion battery are installed, and indicate the condition of each. (Figure 2-3.) Battery 1 is the Lithium ion battery which is installed in Multi-function Bay 1 and Battery 2 is the Lithium ion battery which is installed in Multi-function Bay 2. The battery indicators are displayed only for a battery which is installed.

## Using Your LifeBook 200 Series

A small arrow icon (Battery Charging indicator) appears to the left of each of the Battery Level indicators and above the number (Battery identifier) if that battery is charging. The Battery Charging indicator flashes if the battery is too hot or too cold to charge. (Figure 2-3.) The Battery Charging indicators operate whether the power switch is Off or On.

The symbols inside the battery outline of the Battery Level indicator show the operating level available in that battery. (Figure 2-4.) If there is no battery charging and the power switch is Off then the AC Adapter indicator and the Battery indicators will all be off.

**CAUTION**

A shorted battery is damaged and must be replaced. (See Figure 2-4.)

**CAUTION**

Turning off the power with the power switch or using the Suspend/Resume button when any of the Access indicators are On may cause loss of data and/or system errors.

**CAUTION**

Batteries subjected to shocks, vibration temperatures or extreme temperatures can be permanently damaged.

**CD-ROM Drive Access Indicator**

The CD-ROM Access indicator tells you the CD-ROM drive is being accessed. The CD-ROM Access indicator will flash when the software tries to access a CD or CD-ROM even if no CD-ROM drive is installed.



76%–100%



51%–75%



26%–50%



13%–25%



Low Warning 12%



Dead Battery



Shorted Battery

Figure 2-4 Battery Level Indicator

 **POINT**

The Windows 95 CD automatic insertion function will periodically check for a CD installed in the drive, causing the CD-ROM Access indicator to flash. The CD automatic insertion function allows your system to automatically start a CD as soon as it is inserted in the drive and the tray is closed. It will begin playing an audio CD or will start an application if the CD has an auto run file on it.

 **POINT**

If you do not wish to have the CD automatic insertion function on you can disable it.

**To disable the CD automatic insertion function do as follows:**

1. **Save all data and close all applications.**
2. **Click on the Start button.**
3. **Point to Settings.**
4. **Click on the Control Panel. The control panel window will be displayed.**
5. **Double click on the System icon. The system properties dialogue box will be displayed.**
6. **Click on the Device Manager tab. The device list will be displayed.**
7. **Click on the + to the left of the CD-ROM icon. The CD-ROM drive manufacturer's name and model will be displayed.**
8. **Click on the CD-ROM drive manufacturer's name and model.**
9. **Click on Properties. The CD-ROM drive manufacturer's name and model properties dialogue box will be displayed.**
10. **Click on the Settings tab.**
11. **Click on the automatic insertion notification box to toggle it off.**
12. **Click on OK.**
13. **Click on OK in the system properties dialogue box.**
14. **Restart your notebook according to the message displayed.**

You can re-enable the function by repeating the process except in step 11 change the setting to on.

**Hard Drive and Zip Drive Access Indicator**  
The Hard Drive Access indicator tells you when the internal hard drive, the Zip drive, or the optional second hard drive is being accessed.

 **POINT**

The Hard Drive Access indicator does not show which hard drive or Zip drive is being accessed. It works the same for both hard drives and Zip drives.

**Floppy Disk Drive Access Indicator**

The Floppy Disk Drive Access indicator tells you a floppy disk drive is being accessed. The Floppy Disk Drive Access indicator will flash when your software tries to access a floppy disk even if no floppy disk drive is installed.

**PC Card Access Indicators**

The PC Card Access indicators tell you when an installed PC Card is being accessed. Card 1 is the bottom connector inside the slot and Card 2 is the upper connector inside the card slot. Type III cards are always Card 1 only. The PC Card Access indicator will flash if your software tries to access a PC Card even if none are installed.

**NumLk Indicator**

The NumLk indicator tells you the internal keyboard is set in ten-key numeric keypad mode. (See page 33 for more information on the numeric keypad.) You can activate the NumLk mode by pressing the NumLk/Scr Lk key while holding down the Shift key. Deactivate the mode the same way that you activated it.

**CapsLock Indicator**

The CapsLock indicator tells you when the keyboard is set for all capital letters. Activate the all capital letters setting by pressing the CapsLock key on the keyboard. Deactivate the mode the same way that you activated it.

**Scr Lk Indicator**

The Scr Lk indicator tells you when scroll lock is active. You can activate or deactivate the scroll lock by pressing the NumLk/Scr Lk key. Deactivate the mode the same way that you activated it.

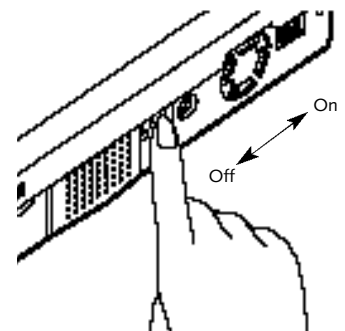


Figure 2-5 Power Switch

**POWER ON**

Facing the keyboard and display panel, move the power switch towards the rear of your notebook. This is the On position. (See Figure 2-5.) When you are done working you can leave your notebook in Suspend mode (see pages 43 and 84), or you can turn it off. The power switch moved toward the front of your notebook is in the Off position. (See the section Power Off, pages 24-25, for the recommended shutoff procedures.)

 **CAUTION**

After turning off your notebook, make sure that it has been Off at least 10 seconds before turning the power switch to On. If you do not you could cause a system error. When you turn on your notebook be sure you have a power source. This means that at least one battery is installed and charged, or that the AC adapter or the auto/airline adapter is connected and has power.

 **CAUTION**

Do not carry your notebook around with the power on or subject it to shocks or vibration, as you risk damaging your notebook.

 **CAUTION**

The main Lithium ion battery is not charged when you purchase your notebook. Initially you will need to connect the AC adapter to use it. If you purchase an optional second Lithium ion battery, it will not be charged when you get it, you will need to charge it prior to use.

**When the power switch is turned on, your notebook carries out a Power On Self Test (POST) to check the internal parts and configuration. If a fault is found a beep will sound and/or an error message will be displayed. (See Troubleshooting on pages 138-140) Depending on the nature of the problem you may be able to continue by starting the operating system or by entering the setup utility and revising the settings.**

**After satisfactory completion of the Power On Self Test (POST) your notebook will load your operating system. (See Boot Menu on pages 88-89 to see which kind of disk will be the source.)**

 **CAUTION**

Never turn off your notebook during Power On Self Test (POST) or it will cause an error message to be displayed when you turn your notebook on the next time. (See the Troubleshooting information on pages 138-140.)

**POWER OFF**

**Before turning off the power by putting the power switch in the Off position, check that the Hard Drive/Zip Drive, CD-ROM, PC Card and the Floppy Disk Drive Access indicators are all Off. (See Figure 2-3, page 20.) If you turn off the power while accessing a disk or PC Card there is a risk of loss of data. The Off position is reached by facing the keyboard and display panel, and moving the switch toward the front of your notebook. To assure that your notebook shuts down without error, use the Windows 95 shut down procedure.**

**CAUTION**

Never turn your notebook off while an application is running. Be sure to close all files, exit all applications and shut down your operating system prior to turning off the power with the power switch. If files are open when you turn the power off, you will lose any changes that have not been saved, and may cause disk errors.

**Shutting down your notebook from Windows 95 lets your notebook shut down operations, and turn off the power in the proper sequence to prevent errors. The sequence is:**

1. Go to the Start button menu.
2. Click on `ShutDown`.
3. Verify that `Shut down the computer?` is selected and click on `Yes`.

**If you are going to store your notebook for a month or more, take the following precautions:**

1. Remove any CD and/or floppy disk.
2. After shutting down with Windows 95 turn off your notebook using the power switch.
3. Close your notebook display panel.
4. Disconnect the AC adapter.
5. Remove the batteries and store them separately in a cool dry place.

**POINT**

When your notebook has been shut down from Windows 95, it is not the same as being turned off from the power switch. It is in a pseudo-off state, with all applications closed, but can and must be turned on by pressing the Suspend/Resume button. It is drawing some current in the pseudo-off state.

**RESTARTING THE SYSTEM**

**When you wish to restart your system be sure that you follow the proper procedure. The procedure is as follows:**

1. Go to the Start button menu.
2. Click on `ShutDown`.
3. Click on `Restart the computer?`
4. Verify that `Restart the computer?` is selected and click on `Yes`.

Windows 95 will shutdown and restart your notebook.

**NOTE:** You may also select `Shut down the computer?` and once the power is off for 10 seconds or more you can restart your notebook with the `Suspend/Resume` button. You may also select `Shut down the computer?` and once the power is off turn the power switch to `Off` for 10 seconds or more and then turn the power switch to `On`. These alternative methods are not recommended.

 **POINT**

In Windows 95 pressing the Ctrl+Alt+Del keys simultaneously triggers the ShutDown submenu of the Start menu.

 **CAUTION**

Turning off the power switch without exiting Windows 95 may cause an error when you start the next time. Turning the power to On when it has been Off for less than 10 seconds may also cause an error when you start the next time.

**FUJITSU WELCOME CENTER**

The Fujitsu Welcome Center is an icon on your Windows 95 desktop. Clicking on it gives you access to product registration forms and instructions, change of address information and forms, contact information including telephone numbers and e-mail addresses, and an accessory

catalog with the information for ordering accessories for your notebook. Double left-click on the icon and then on the appropriate button for the information selection you wish.

**BATTERIES**

The Lithium ion batteries are rechargeable with an operating time of up to three (3) hours depending on active power management features and user activity levels. Your notebook can be operated on the primary Lithium ion battery alone or in a dual battery configuration with an optional second Lithium ion battery. A built-in bridge battery allows a charged Lithium ion battery to be exchanged for a discharged one by "warm-swapping". To warm-swap, have a charged battery ready, put your notebook in Suspend mode, remove the low battery and quickly insert a charged battery. (For more information on warm-swapping see page 122.)

The Lithium ion battery operating time may become shorter than the reference value if it is used under the following conditions:

- When used at temperatures that exceed a low of 5°C or a high of 35°C. High temperatures not only reduce charging efficiency, but can also cause battery deterioration. (The Charging icon on the Status Indicator panel will flash when you try to charge a battery that is outside its operating temperature range.)
- The battery charging capacity is reduced as the battery ages. If your battery is running low quickly, you should replace it with a new one.
- When using a high current device such as a modem, a LAN card, the CD-ROM drive, or the hard drive frequently.

Using the AC adapter will conserve your battery when using a high current device such as a modem, a LAN card, the CD-ROM drive, or the hard drive frequently.

**CAUTION**

Actual battery life will vary based on screen brightness, applications, features, power management settings, battery condition, and other customer preferences. CD-ROM drive, hard drive, and Zip Drive usage may also have a significant impact on battery life.

**CAUTION**

Do not leave a faulty battery in your notebook. It might damage your AC adapter, optional auto/airline adapter, another battery, or your notebook itself. It may also prevent operation of your notebook by draining all available current into the bad battery.

**CAUTION**

Under federal, state or local law it may be illegal to dispose of batteries by putting them in the trash. Please take care of our environment and dispose of batteries properly. Check with your local government authority for details regarding recycling or disposing of old batteries. If you cannot find this information elsewhere, contact your support representative at 1-800-8FUJITSU (1-800-838-5487).

**Bridge Battery**

**The bridge battery is a NiCd battery that is built-in your notebook and is constantly being recharged. A bridge battery allows a charged Lithium ion battery to be exchanged for a discharged one by “warm-swapping”.**

**To warm-swap, have a charged battery ready, put your notebook in Suspend mode, remove the low battery and quickly insert a charged battery. The bridge battery capacity is not large, about 3 minutes, and can vary with the condition of your notebook.**

**CAUTION**

Data may be lost and/or system errors introduced if the warm-swap is not performed quickly or a power adapter installed.

**CAUTION**

The bridge battery can not support an active notebook. The notebook must be in Suspend mode.

### Shorted Batteries

If your Status Indicator panel shows a shorted battery, check the installation for that battery by removing and re-installing it. If it still shows that it is shorted, replace it with a new battery.



#### CAUTION

A shorted battery is damaged and must be replaced so that it does not damage anything else.

### Recharging the Batteries

If you want to check the condition of either the primary Lithium ion battery or an optional second Lithium ion battery, check the Battery Level indicators located on the Status Indicator panel. These indicators change as the battery levels change. Battery 1 is a Lithium ion battery which is installed in Multi-function Bay 1 and Battery 2 is a Lithium ion battery which is installed in Multi-function Bay 2. (Figure 2-3 on page 20.) You can also check the PowerPanel toolbar.

The Lithium ion batteries are recharged internally using the AC adapter or auto/airline adapter. To recharge the batteries:

- Make sure the battery to be charged is installed in either Multi-function bay of your notebook and connect the AC or auto/airline adapter.
- Make sure that the Battery Charging indicator to the left of the Battery Level indicator of the battery to be charged is visible on the Status Indicator panel.
- Make sure the percentage charge is shown inside the Battery Level icon. (Figure 2-4 on page 21.)

When two Lithium ion batteries are installed, the charge/discharge rate of the primary and optional second Lithium ion batteries are the same, as they are connected in parallel and are both charging and/or discharging at the same time. Since the rates are the same, one may finish charging or discharging before the other if

they were not at the same charge level when they were installed and/or the AC or auto/airline adapter was connected.

There is no memory effect on the Lithium ion batteries, which means that you do not need to discharge them completely before recharging. A single fully discharged Lithium ion battery will charge in approximately three (3) hours when your notebook is Off or in Suspend mode. The charging time from fully discharged for two Lithium ion batteries together, is approximately 5 hours when your notebook is Off or in Suspend mode. Of course partially charged batteries will not take as long to charge. The charge times will be significantly longer if your notebook is in use while the batteries are charging (from approximately nine (9) hours for one battery to approximately 15 hours for two batteries with normal operating levels).



#### CAUTION

Using heavy current devices such as LAN cards or frequent CD-ROM accesses may prevent charging completely.

### Low Battery State

When the battery is running low, your notebook beeps about every 15 seconds and the Battery Level indicator(s) flash. If you do not respond to the low battery alarm, the batteries will continue to discharge until they are too low to operate. When this happens there will be a multiple beep alarm, the Battery Level indicator will show dead battery, and your notebook will go into Suspend mode to try and protect your data as long as possible. Your power management settings do not affect what happens at the dead battery alarm level. Your notebook will go to Suspend mode. (Figure 2-3 on page 20.)



#### CAUTION

You may not be able to hear the audio alarms if the volume control is set too low or is turned off by either hardware or software but you will still be able to see the Battery Level indicator(s) flash.

When the low battery alarm occurs you need to save all your active data and put your notebook into Suspend mode until you can provide a new power source. You should provide this power as soon as possible. The new power source can be a charged battery or a power adapter, either AC or auto/airline.



#### CAUTION

When you are in Suspend mode there must always be at least one power source active. If you turn off the power with the power switch, or remove all power sources, battery, AC adapter or auto/airline adapter, while your notebook is in Suspend mode any data which has not been saved to the hard drive will be lost.

**Once your notebook goes into Dead Battery Suspend mode you will be unable to resume operation until you provide a source of power either from an AC adapter, an optional auto/airline adapter, or a charged battery. Dead**

**Battery Suspend mode shows on the Status indicator just like the normal Suspend mode. Once you have provided power, you will need to press the Suspend/Resume button to resume operation. In the Suspend mode, your data can be maintained for sometime. If a power source is not provided promptly, the Power indicator will stop flashing and go out, and you will have lost the data that was not stored.**

**Once you provide power you can continue to use your notebook while an adapter is charging the battery, but the battery trickle charges under these conditions. If you want to charge the battery more quickly, put your notebook into Suspend mode, or turn off your notebook while the adapter is charging the battery. (See Power Off on pages 24-25 for shutdown procedures.)**



#### CAUTION

There is no guarantee that data will not be lost once your notebook enters the Dead Battery Suspend mode.

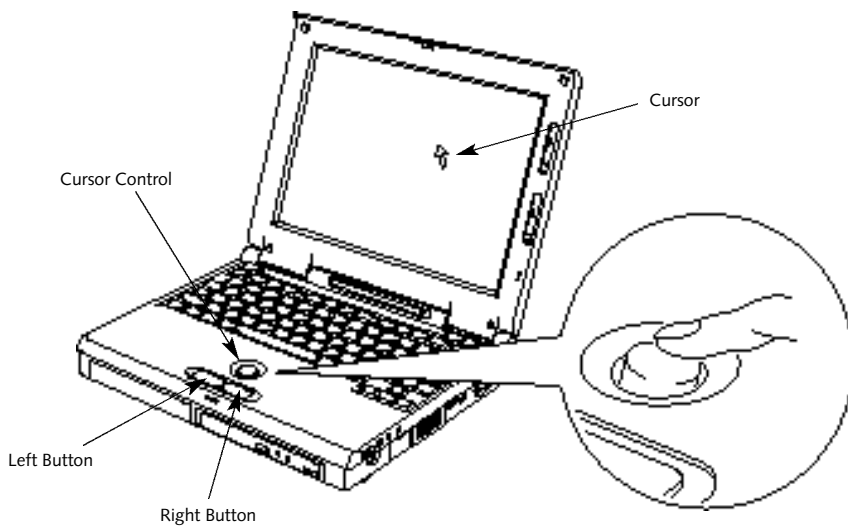


Figure 2-6 ErgoTrac pointing device

### INTEGRATED ERGOTRAC POINTING DEVICE

The ErgoTrac pointing device is composed of a short, comfortable, dish-shaped pointing device and two buttons located in front of the keyboard. The ErgoTrac pointing device has the function of a mouse, and moves the cursor around on the screen – up, down, left and right. A light pressure with the tip of your finger is all that is required to operate the ErgoTrac. The more pressure you use the faster the cursor will move. The second part of the ErgoTrac pointing device – the buttons – function as mouse buttons, and the functions they perform depend on the application you are running. Figure 2-6 shows the position of the ErgoTrac pointing device and buttons.



#### POINT

An external mouse can be connected to the PS/2 port on the right side of the notebook, and used simultaneously with the ErgoTrac pointing device.

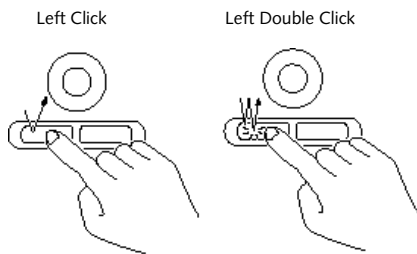


Figure 2-7 Clipping

### Clicking

**Clicking means pushing and releasing a button. To left-click move the screen cursor to the item you wish to select, press the left pointing device button once, and then immediately release it. To right-click, move the mouse cursor to the item you wish to select, press the right pointing device button once, and then immediately release it. (Figure 2-7.)**

### Double-Clicking

**Double-clicking means following the preceding Clicking procedure, but pressing the pointing**

**device button twice in rapid succession. Double-clicking works with both the left and right buttons.**



### CAUTION

If the interval between clicks is too long, double-clicking will not be executed.



### POINT

The interval between presses for double clicking, and other parameters of pointing and selecting, can be adjusted with the selections in the dialog box of the mouse icon in your Windows Control panel.

### Dragging

**Dragging means selecting an item with the pointing cursor, and while keeping the left pointing device button depressed, moving the cursor to the desired new location, then releasing the button. (Figure 2-8.)**

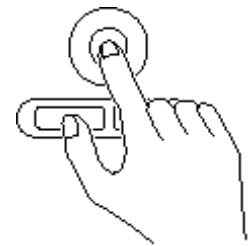


Figure 2-8 Dragging

### ErgoTrac Pointing Device Control Adjustment

**The Windows Control Panel provides customization of your ErgoTrac pointing device from the mouse icon. There are four (4) aspects of the ErgoTrac pointing device operation which you can adjust.**

- **Buttons** – This lets you set up the buttons for right or left handed operation and set the time interval for double clicking.

- **Pointers** – This lets you set up the size and shape of the cursor for different functions.
- **Motion** – This lets you set up the relation of the speed of motion of your finger to the motion of the cursor and to enable a trailing tail for the cursor arrow.
- **General** – This allows you to choose the type of mouse being used. It is already set for your integrated ErgoTrac. You may need to change it for an external mouse.

You may want to try practicing with different adjustments until you find a combination that is comfortable for you.

#### USING THE KEYBOARD

Your notebook has an integral 86-key keyboard. (Figure 2-9.) The keys perform all the standard functions of a 101-key keyboard and also include Windows 95 keys and other special function keys. This section describes only those items specific to your notebook. They are the numeric keypad, the cursor keys, the function keys, the function extension key (Fn) and the Windows 95 keys.

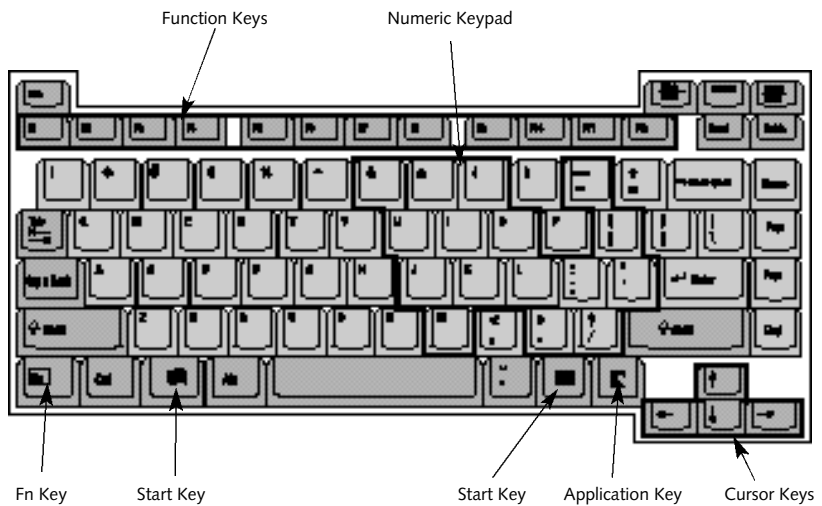


Figure 2-9 Keyboard

### Numeric Keypad

Certain keys on the keyboard perform dual functions as both standard character keys and numeric keypad keys. Figure 2-9 highlights these keys. To switch into numeric keypad mode, press the NumLk/Scr Lk while holding down the Shift key. You can now enter numerals 0 through 9, perform addition (+), subtraction (-), multiplication (\*), or division (/), and enter decimal points (.) using the keys designated as ten-key function keys. The keys in the numeric keypad are marked on the front edge of the key to indicate their secondary functions.

To return these keys to their normal character function, press the NumLk/Scr Lk while holding down the Shift key again.



#### POINT

When an external numeric keypad is connected to the notebook the NumLk mode enables the external keypad and disables the built-in keyboard numeric keypad.

### Cursor Keys

The cursor keys are the four arrow keys on the keyboard which allow you to move the cursor up ↑, down ↓, left ← and right → as your application allows.



#### POINT

The integrated ErgoTrac pointing device and/or external mouse are also used for moving the cursor around the screen.

### Function Keys

Your notebook has 12 function keys, F1 through F12. The functions assigned to these keys differ for each application. You should refer to your software documentation to find out how these keys are used. (See Figure 2-9.)

### Fn Key

The Fn key provides extended functions for the notebook and is always used in conjunction with another key. (See Figure 2-9.)

Pressing F5 while holding down the Fn key allows you to toggle between video compensation and no compensation. (Video compensation controls spacing on the display. When it is enabled, displays with less than 800 x 600 pixel resolution will still cover the entire screen.)

Pressing F10 while holding down the Fn key allows you to change your selection of where to send your display video. Each time you press the combination of keys you will step to the next choice. The choices, in order, are: built-in display panel only, external monitor only, or both built-in display panel and external monitor.

### Windows 95 Keys

Your notebook has three Windows 95 keys, two Start keys and an Application key. The Start key displays the Start menu. This is the same as the button on the toolbar which is typically at the bottom of your Windows 95 desktop. The Application key has the same function in Windows 95 as the right mouse button, it displays the Shortcut menu for whatever item is selected. See your Windows 95 documentation for additional information. (See Figure 2-9.)

## VOLUME CONTROL

All system and application functions have multiple volume controls which interact with each other. There is the hardware volume control on the right side panel of your notebook. There is a volume control in the ESS AudioRack, your operating system Sound Control panel and any other application with sound.

Each setting source puts an upper limit on the volume which can be set by the other sources. For example if the hardware volume control is turned all the way down, your software volume control settings have no effect. By the same token, if the ESS AudioRack has the sound turned off, adjusting the hardware or other application software volume settings will not produce sound. One easy operating method is to use the hardware and ESS AudioRack volume controls to set an upper limit on sound level and then make fine adjustments with other application software.



### CAUTION

The ESS AudioRack volume setting sets the maximum volume level of the hardware volume control knob.



### CAUTION

If you use a speakerphone function, be sure that the microphone setting in the ESS AudioRack (recorder portion) is disabled.

## FLOPPY DISK DRIVE

The modular floppy disk drive is a 3.5" drive which can read and write on 1.44MB and 720KB memory capacity floppy disks. Floppy disk format is controlled from your operating system. (See your software documentation for more information.) The modular floppy disk drive can be used in Multi-function Bay 1, Multi-function Bay 2 with the Bay Adapter for Multi-function Bay 2, or you can use the optional external floppy disk drive. The system will

treat any floppy disk drive in exactly the same way regardless of where it is installed. (For floppy disk drive installation and removal instructions see Multi-function Bays on pages 97-100 and External Installation of a Floppy Disk Drive on page 107.) When your system boots it will always look first for a floppy disk drive in a Multi-function Bay 1, Multi-function Bay 2, and then look at the external floppy disk drive port.



### CAUTION

To get your system to recognize a newly installed floppy disk drive you must restart your notebook.

## Loading a Floppy Disk

To load, insert a floppy disk into the floppy disk drive, shutter side first and label up, until the Eject button, above the floppy disk drive opening, pops out. (Figure 2-10)

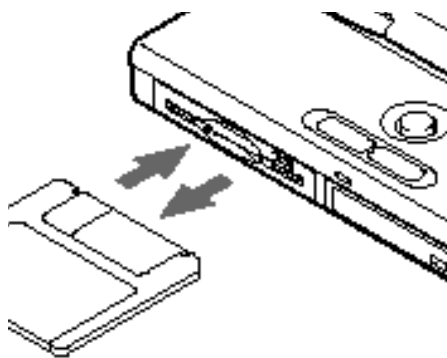
**Using Your LifeBook 200 Series**

Figure 2-10 Loading/Ejecting a Floppy Disk

**POINT**

When there is no floppy disk in the drive, the Eject button is flush with the front of your notebook.

**Ejecting a Floppy Disk**

To eject a disk, check that the Floppy Disk Drive Access indicator is Off, (see pages 20 and 23) and press the Eject button. (Figure 2-10.)

**CAUTION**

If you eject the disk while the Floppy Disk Drive Access indicator is On, there is a risk of damaging the data on the disk or the disk drive.

**Preparing a Floppy Disk for Use**

Before you can use a new floppy disk, you need to prepare it so your notebook knows where to store information. This preparation is called formatting or initializing a disk. You need to format new 3.5" floppy disks, unless you purchase preformatted disks. You will use your notebook's operating system software to format a floppy disk. Please refer to the operating system manual for step-by-step instructions.

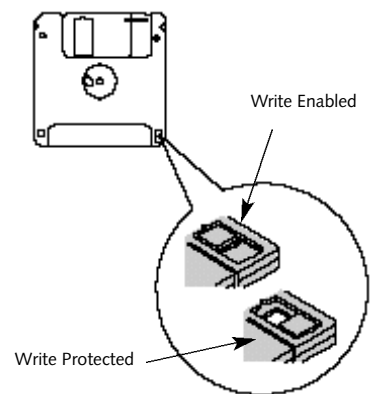


Figure 2-11 Floppy Disk Write Protect

To prevent data stored on a floppy disk from being erased, slide the write protect tab on the floppy disk to open up the small hole. This makes the disk write protected. When you want to write data to that disk, slide the write protect tab the other way to close the small hole.

**CAUTION**

Formatting a previously used floppy disk is an effective method of clearing a disk as long as you realize that ALL the information on the disk will be erased.

**Care of Floppy Disk Drives and Disks**

- **Avoid storing the floppy disk drive and disks in extremely hot and cold locations, or in locations subject to severe temperature changes.**
- **Keep the floppy disk drive and disks out of direct sunlight and away from heating equipment.**
- **Avoid storing the floppy disk drive in locations subject to shock and vibration.**
- **Avoid using the floppy disk drive and disks in damp and dusty locations.**
- **Never use the floppy disk drive with any liquid, metal, or other foreign matter inside the floppy disk drive or disk.**

- **Never store a floppy disk near a magnet or magnetic field.**
- **To clean, wipe the floppy disk drive clean with a dry soft cloth or with a soft cloth dampened with water or a solution of neutral detergent. Never use benzene, paint thinner, or other volatile material.**
- **Never disassemble or dismantle your floppy disk drive.**

**CD-ROM DRIVE**

The modular CD-ROM drive is a 20-speed maximum modular reader.

**CAUTION**

Do not operate your CD-ROM drive unless your notebook is sitting on a flat surface and the adjustment feet are folded against the bottom of the notebook. Using a CD when the drive is not level may damage the drive or prevent proper operation.



Figure 2-12 Loading the CD-ROM Tray

#### Loading a CD

- Make sure that the angle adjustment feet on the bottom of the notebook are folded against the bottom of the notebook.
- Make sure there is power to your notebook.
- Push, gently but firmly, and release the eject button on the front of the CD-ROM drive to open the CD-ROM holder tray, the tray will come out a short distance.
- Gently pull the tray out until a CD-ROM can be easily placed in the tray.
- If there was a protective sheet in the tray when it was shipped, make sure it has been removed.
- Place the CD into the tray, label side up, with the hole in the center of the CD snapped onto the raised circle in the center of the tray.
- Close the tray.
- After the CD is loaded, it will take a short time for your notebook to recognize it.



#### POINT

If you have disabled your CD automatic insertion function you will have to start the CD from your desktop, as your notebook will not automatically recognize that the CD has been loaded.

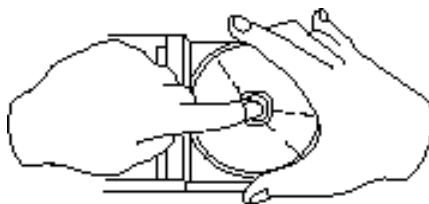


Figure 2-13 CD-ROM Handling

#### Care of CD-ROMs

CD-ROMs are precision devices and will function reliably if given reasonable care.

- Always store your CD-ROM in its case when it is not in use.

- When removing the CD-ROM from its case, press down on the holder's center while lifting out the CD-ROM by its edges.
- Always handle a CD-ROM by the edges and avoid touching the surface.
- Avoid storing any CD-ROM in extreme temperatures.
- Do not bend CD-ROMs or set heavy objects on them.
- Never write on the label surface with a ball point pen, pencil or similar device.
- If a CD-ROM is subjected to a sudden change in temperature, cold to warm condensation may form on the surface. Wipe the moisture off with a clean, soft, lint free cloth and let it dry at room temperature. DO NOT use a hair dryer or heater to dry a CD-ROM.
- If a CD-ROM is dirty, use only a CD-ROM cleaner or wipe it with a clean, soft, lint free cloth starting from the inner edge and wiping to the outer edge.

### IOMEGA ZIP DRIVE

The 100MB Iomega Zip drive is a modular removable media drive designed for use in either Multi-function bay of your LifeBook 200 Series notebook. The Zip tools software (pre-installed on your notebook) allows easier management of information on Zip disks and the functionality of Zip disks and drives with the operating system.

The Zip drive has an automatic sleep mode designed to reduce power consumption and prolong the life of the battery in your notebook. Sleep mode automatically spins down a disk after a set period of inactivity; the disk automatically spins up again when accessed.

Inserting and removing Zip disks  
To insert a disk in the Zip drive:

- Orient the disk with the label side up, and the sliding metal access door of the disk toward the drive.
- Insert the disk gently into the drive until it clicks in, and engages in the drive.

- The green busy light will flash momentarily and then go out. (If the light continues to blink slowly, push the disk eject button to eject the Zip disk, then reinsert it.)
- To remove a Zip disk, press the gray button on the front of the drive, or click on the Zip 100 icon in the My Computer window with the right mouse button and select eject.
- When you remove a Zip disk from the drive, store it in the protective case.
- The Zip drive will automatically eject the disk when you shut down your LifeBook 200 Series notebook.
- Store all your Zip disks in the protective case when not in use.

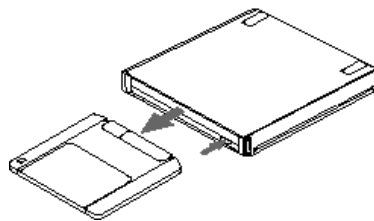


Figure 2-14 Ejecting the Iomega Zip disk



#### POINT

Zip Disks must be purchased separately



#### CAUTION

When using the disk eject button, push gently. Do not use force! The green busy light blinks as the disk “spins down” and the drive takes a few seconds to eject the Zip disk. Never force a disk into or out of the Zip drive.

#### Emergency Disk Eject

Your LifeBook 200 Series notebook must be powered on for normal disk ejection from the Zip drive. Never use force to remove a disk from the Zip drive. If you must remove a Zip disk from the drive when power is not available, carefully push a straightened paper clip into the emergency eject hole located on the eject button. Use care when using this method as excessive force or a bent paper clip may cause damage to your Zip drive.

**CAUTION**

Use the emergency disk eject procedure only when the laptop is without power. Do not try to forcibly remove a Zip disk from the drive. If the disk does not eject immediately, repeat the emergency disk eject procedure as described above.

**Zip Disk Tips**

- **Never force a Zip disk into or out of the drive.**
- **It is a good idea to return the Zip disk to its case when it is not in use.**
- **Avoid exposing Zip disks to direct sunlight, high temperature, moisture, and magnetic fields.**

**Read/Write Protecting Zip Disks**

Your Zip Tools software includes a special read/write protect feature that lets you:

- **Write protect a Zip disk through special software instead of with a mechanical write protect switch.**

- **Write protect a Zip disk and assign a password that must be used to remove the write protect.**
- **Read Protect a Zip disk so that it cannot be read from, or written to, unless the user enters the password you assign.**

**For information on using read/write protect, refer to the Zip Tools help file.**

**HARD DRIVE**

**The internal hard drive capacity is dependent on which model you are using. See Appendix A (pages 150–163) for model information. If you are using the optional second hard drive for the first time since you installed it, you can get your notebook to recognize it by opening the Windows 95 Control Panel and opening Add New Hardware which will step you through the process of having Windows look for your newly installed device.**

**Formatting the Hard Drive**

**The hard drive inside your notebook is formatted (initialized) at the factory. You do not need to format it under normal circumstances. If you**

**purchase an optional second hard drive you will need to format it before you use it the first time. Check your operating system documentation for information on initializing a hard drive.**

**CAUTION**

If you reformat the internal hard drive ALL data including the operating system, applications software and data will be erased. Unless data is copied to floppy disks or other data storage media it will be permanently lost. All software will be need to be re-installed and data files restored from your back-up disks. See the operating system manual for more information on backing-up your data files. The factory installed software, including the operating system, can be restored from the Recovery CD-ROM which came in the accessories box when you purchased your notebook. (See *Restoring Your Pre-installed Software from CD-ROM on page 141 for more information.*) Any application software which you have purchased and installed

will have to be re-installed from the original source. When doing a recovery remember that you must allocate space for the Save-to-Disk function if you have it enabled. (See *Setting Up Your Save-to-Disk File Allocation* on pages 93-94 for more information.)

## POWER MANAGEMENT

Your LifeBook 200 Series has many features for conserving power. Some power savings features are automatic and have no user control, such as those for the internal modem, while others depend on the parameters you set to best suit your operating conditions. Other power saving features turn the display brightness down, limit the use of high power devices, activate an appropriate power savings profile, and put your notebook in Suspend mode when not actually performing an operation. As with all mobile, battery-powered computers, there is a trade-off between performance and power savings.



Figure 2-15 Suspend/Resume Button

Internal power management for your notebook is controlled from settings made in the BIOS setup utility, PowerPanel by Phoenix Technologies, and the Windows 95 Control panel. If no settings have been made in the PowerPanel or Windows 95 Control panel then the BIOS settings will be used. The PowerPanel and Windows 95 Control panel have been pre-set at the factory and will be active unless you disable them. Complete descriptions of the BIOS setup utility parameters are found in Section Three of this guide. Power management parameters are covered under the Power Savings menu. (See pages 81-87.)

Some particular power parameters are only available for setup from one of these places, others can be changed in any one of them.

### Using the Suspend/Resume Button

When your notebook is active, the Suspend/Resume button (Figure 1-7 on page 7) can be used to manually put your notebook into Suspend mode, or into the Save-to-Disk mode. Push the Suspend/Resume button, when your notebook is active but no Access indicators are on, and hold it in until it is acknowledged by activation of the selected mode. Which mode is activated is determined by the settings of the BIOS setup utility Power Savings menu. The default is Suspend mode. (See page 84 for how to select Save-to-Disk mode.)

If your notebook is suspended, pushing the Suspend/Resume button will return your notebook to active operation at the point where it went into suspension. The Suspend/Resume button is located next to the Status Indicator panel above the keyboard of your notebook. (Figure 2-14) You can tell whether or not your

system is in Suspend mode by looking at the Power indicator. (See pages 19-20.) If it is visible and not flashing, your notebook is fully operational. If it is visible and flashing, your notebook is in Suspend mode. If it is not visible, the power is Off, the power is in the Windows 95 pseudo-off state, or your notebook is in Save-to-Disk mode. (See pages 44-45.) When you receive your LifeBook 200 Series it will be set to the default, which is Suspend mode.

**CAUTION**

Be sure you know which settings are active for the Suspend/Resume button before you use it; misuse can result in data loss. (See the *Power Savings Menu of the BIOS setup utility*, pages 81-87, for more information.)

**POINT**

Disabling the Suspend/Resume button prevents it from being used to put your notebook in Suspend or Save-to-Disk mode. The resume function of the button cannot be disabled. (See the *Power Savings Menu of the BIOS setup utility*, pages 81-87, for more information.)

**POINT**

If your notebook is active when you enter the Suspend or Save-to-Disk mode, changes to open files are not lost. The files are left open and memory is kept active during Suspend mode or the memory is transferred to the internal hard drive during Save-to-Disk mode.

**CAUTION**

The Suspend or Save-to-Disk mode should not be used with certain PC Cards. Check your PC Card documentation for more information.

**CAUTION**

If you are running your notebook on battery power, be aware that the battery continues to discharge while your notebook is in suspend mode, though not as fast as when fully operational. With a fully charged internal Lithium ion battery the suspend mode will maintain your status for 24 hours or more.

**PowerPanel**

**PowerPanel by Phoenix Technologies provides Windows 95 desktop access to a comprehensive combination of power management settings without entering the BIOS setup utility.**

The PowerPanel icon looks like an atom with its cloud of electrons. This icon will open the PowerPanel menu. You can view the menu in icon format along the edge of your desktop by moving the cursor against the edge where you have chosen to keep your PowerPanel toolbar and letting it sit there until the toolbar appears. (The default position for the toolbar is the left side of the screen, but you can move it to whichever edge you like by dragging.)

The power management toolbar has ten power profile choices and six activation choices. When you switch to AC powered operation the PowerPanel toolbar will automatically change to indicate AC power operation and will show the AC Power profile as active.

The profiles are groups of system settings designed to fit power operation to specific user operating conditions. The activations are short-cut ways to turn on specific power management features of your notebook. Some of the profiles can be edited and saved from the PowerPanel application, some can be edited and saved from

the BIOS setup utility and only viewed from PowerPanel, and some are factory set and can only be viewed from either PowerPanel or the BIOS setup utility.

The profile choices are:

(This group is factory set.)

- Maximum Battery Life.
- Maximum Performance.
- Power Management Off.

(This one is set only from the BIOS setup utility.)

- Custom Settings.

(This group is set from PowerPanel.)

- Presentation.
- Green PC.
- AC Profile.
- Word Processing.
- Communication.
- Games.

The activation choices are:

- System Suspend.
- System Save-to-Disk.
- System Standby.
- Hard Disk Standby.
- Modem Power Toggle.
- Video Standby.

The factory set Maximum Power Savings profile is designed around trade offs of performance and battery life. For truly maximum battery life keep the display and volume levels as low as possible and use the custom settings recommended in Section Three on page 100.



#### POINT

The AC Power profile is activated automatically when a power adapter is being used, unless it is overridden by another selection made after the adapter became active. It can be reactivated by selecting it or it can be activated by selection, even when operating only on battery power.

## POWERPANEL ONLINE HELP

To access help with your power management settings, move your cursor to the PowerPanel toolbar and right click. (See *Clicking on page 33.*) From the menu that appears select PowerPanel Help Topics.

## POWERPANEL CUSTOMIZATION

To modify your PowerPanel toolbar or create a custom toolbar, move your cursor to the PowerPanel toolbar and right click. From the menu that appears select Customize. Within the Customize dialog box you can choose to have the toolbar display at all times or to use your custom toolbar. You can also select from the same menu to Hide the toolbar. If you hide the toolbar you will have to double click on the edge where the toolbar was located to display it.

If you select **Exit** from the PowerPanel menu you will turn off the PowerPanel completely. To turn it back on, go to the Program folder of the Start menu, select PowerPanel and click on it.

## MAXIMUM BATTERY LIFE PROFILE

The Maximum Battery Life profile is a factory installed combination of timeouts and other power savings parameters read directly from the BIOS, and chosen as the settings that will produce the longest possible battery life.

## MAXIMUM PERFORMANCE PROFILE

The Maximum Performance profile is a factory installed combination of timeouts and other power savings parameters read directly from the BIOS and chosen as the settings that will produce superior performance with reasonable battery life.

## POWER MANAGEMENT OFF

Turns off power management control from Windows 95 and PowerPanel and turns it over directly to the BIOS.

## CUSTOM SETTINGS PROFILE

The Custom Settings profile has those power saving parameters that you set in the BIOS setup utility using the Power Savings Menu Customize feature. (See *Power Savings on pages 86-93.*)



## POINT

The Maximum Power Savings, Maximum Performance, and Power Management Off profiles are read only. The Custom Settings Profile can only be changed from the BIOS setup Utility.

## PRESENTATION PROFILE

The Presentation profile is the same combination of timeouts and other power savings parameters as the Maximum Battery Life profile except that the display is never turned off. (This profile was designed to enhance the use of your notebook for slide show style presentations.)

## GREEN PC PROFILE

The Green PC profile has the Video timeout and the Hard Drive timeout enabled but no standby or suspension modes enabled.

#### AC PROFILE

The AC power profile has all timeouts disabled and no other power management features enabled. This profile is activated automatically by plugging in a power adapter.

#### WORD PROCESSING PROFILE

The Word Processing profile is a factory installed combination of timeouts and other power savings parameters chosen as the settings that will produce superior performance with reasonable battery life when using your notebook for doing word processing.

#### COMMUNICATION PROFILE

The Communication profile is a factory installed combination of timeouts and other power savings parameters chosen as the settings that will produce superior performance with reasonable battery life when using your notebook with the modem active such as during Internet, fax or speakerphone activities.

#### GAMES PROFILE

The Games profile is a factory installed combination of timeouts and other power savings parameters chosen as the settings that will produce superior performance with reasonable battery life when playing games on your notebook.

#### SYSTEM SUSPEND ACTIVATION

Clicking on the Suspend button or selecting System Suspend on the PowerPanel menu will put your notebook in Suspend mode. Pressing the Suspend/Resume button turns the power back on and lets you begin where you left off. (See Figure 2-14 on page 42, and Suspend Mode on pages 47 and 88.)

#### SYSTEM SAVE-TO-DISK ACTIVATION

Clicking on the Save-to-Disk button or selecting System Save to Disk on the PowerPanel menu will put your notebook in Save-to-Disk mode. Your notebook will be left in the Windows 95 pseudo-off state. If the power switch is not turned off your notebook can be restarted by pressing the Suspend/Resume button which will cause the system memory to reload from the hard drive and let you begin

where you left off. (See Figure 2-14 on page 42, and Save-to-Disk Mode on pages 47-48.)

#### SYSTEM STANDBY ACTIVATION

Clicking on the System Standby button or selecting System Standby on the PowerPanel menu will put your notebook in Standby mode. You can return your notebook to normal operation by performing any activity such as pressing a key or touching the ErgoTrac joystick.

#### HARD DISK STANDBY ACTIVATION

Clicking on the Hard Disk Standby button or selecting Hard Disk Standby on the PowerPanel menu will turn off your internal hard drive. You can return your notebook to normal operation by performing any hard drive operation.

#### MODEM POWER TOGGLE

Clicking on the Modem Power Toggle button or selecting Modem Power Toggle on the PowerPanel menu will turn the power to your modem on or off. To turn it to the other condition select Modem Power Toggle again.

**VIDEO STANDBY ACTIVATION**

Clicking on the Video Standby button or selecting Video Standby on the PowerPanel menu turns off the power to the display. You can return your notebook to normal operation by performing any activity such as pressing a key or touching the ErgoTrac joystick.

**Suspend Mode**

The Suspend mode saves the contents of your notebook's system memory during periods of inactivity by maintaining power to critical parts while turning off the CPU, the display, the hard drive and all of the other internal components except those necessary to maintain system memory, recognize the Suspend/ Resume button and restart. Your notebook can be put in Suspend mode by:

- Pressing the Suspend/Resume button until acknowledged.
- Selecting Suspend from the Windows 95 Start Menu.
- Selecting System Suspend from the PowerPanel toolbar or menu.

- Timing out from lack of activity.
- Battery level reaching the Dead Battery Warning condition.

Your notebook's system memory typically stores the file(s) on which you are working, the open application(s) and any other data required to support the operation(s) in progress. When you resume operation from Suspend mode, it returns to the point in the operation where it left off. You must use the Suspend/Resume button to resume operation, and there must be an adequate power source available, or your notebook will not resume.

**CAUTION**

Loss of all power sources, including batteries, while in the Suspend mode will cause lost data and inability to return to operation with the Suspend/ Resume button.

**Save-to-Disk Mode**

The Save-to-Disk function saves the contents of your notebook's system memory to the hard drive whenever you:

- Press the Suspend/Resume button until acknowledged with Save-to-Disk mode enabled from the Power Savings menu of the BIOS setup utility.
- Select Suspend from the Windows 95 Start menu with Save-to-Disk mode enabled by the BIOS setup utility.
- Select Save-to-Disk activation from the PowerPanel toolbar or menu.
- Time out from lack of activity with Save-To-Disk mode enabled from the Power Savings menu of the BIOS setup utility.

Your notebook's system memory typically stores the file(s) on which you are working, the open application(s) and any other data required to support the operation(s) in progress. When the Save-to-Disk function is activated your notebook saves the contents of the system memory to a file

on the internal hard drive, and then automatically shuts off power to your notebook. This is the same pseudo-off state as the Windows 95 power off. When you resume operation by pressing the Suspend/Resume button, you return to the point in the operation where you left off, before going into Save-to-Disk mode.



**POINT**

If power is lost during Save-to-Disk mode the data will be retrieved automatically as soon as power is returned.



**POINT**

When PC Cards or external devices are in use, Save-to-Disk mode cannot return to the exact state prior to suspension, because all of the peripheral devices will be re-initialized when the system restarts.



**POINT**

The main advantage of using the Save-to-Disk function is that power is not required to maintain your data. This is particularly important if you will be leaving your notebook in a suspended state for a prolonged period of time. The drawback of using Save-to-Disk mode is that it lengthens the power down and power up sequences and resets peripheral devices.



**POINT**

Save-to-Disk mode requires allocating a significant amount of hard drive capacity for saving all system memory, which reduces your usable disk space. When you purchase your notebook it will have space allocated for the memory installed. If you upgrade the original system by adding a memory upgrade module without changing the size of your Save-to-Disk allocation you will get an error message when you try to activate Save-to-Disk mode and it will not work. Use the PHDISK Utility to increase the size of the Save-to-Disk file, SAVE2DSK.BIN. (Refer to *Setting Up Your Save-to-Disk File Allocation* on pages 93-94 for more information.) If you need help contact your support representative for recommendations.

**Idle Mode**

Idle mode is one of the power management parameters. When Idle mode is enabled the CPU is put into low-speed operation when there is no activity (keystroke, pointer action, sound generation, video display change, modem transmission or reception, etc.) on your notebook for 16 seconds. Any activity will cause the normal operation to restart automatically. This feature is independent of the Suspend/Resume button. This parameter is enabled and disabled in the BIOS setup utility. (See page 83.)

**Standby Mode**

Standby mode is one of the power management parameters. When Standby mode is activated, your notebook puts the CPU in low-speed operation, shuts off the display and turns off the hard drive when there is no activity (keystroke, pointer action, sound generation, video display change, modem transmission or reception, etc.) on your notebook for the user selected time-out period. (See page 83.) Any activity will cause your notebook to return to normal

operation automatically. This feature is independent of the Suspend/Resume button. This parameter is enabled and disabled in the BIOS setup utility.

**Video Timeout**

The Video Timeout is one of the power management parameters which saves power by turning off the display if there is no keyboard or pointer activity for the user selected timeout period. Any keyboard or pointer activity will cause the display to restart automatically. This feature is independent of the Suspend/Resume button. This parameter is enabled and disabled in the BIOS setup utility. (See page 82.)

**Hard Disk Timeout**

The Hard Disk Timeout is one of the power management parameters which saves power by turning off the hard drive if there is no hard drive access for the timeout period which has been set in the BIOS setup utility. (See page 82.) Any attempt to access the hard drive will cause the hard drive to restart automatically. This feature is independent of the Suspend/

Resume button. This parameter is enabled and disabled in the BIOS setup utility.

**Windows 95 Control Panel**

The Power icon in the Windows 95 Control Panel allows you to enable or disable all the power management settings which can be made from the desktop. Selecting "Allow Windows to manage power use on this computer" allows the operating system to enable Phoenix Technologies PowerPanel and Windows 95 Control panel settings. When Windows 95 power management is disabled the BIOS setup utility settings will control your power saving parameters. (See pages 81-87 for the BIOS setup utility Power Savings menu.)

The Windows 95 Control Panel Power Management dialog box lets you set different hard drive timeouts for battery and AC power operation and to set PC Card modem power parameters.

 **POINT**

You must restart your notebook for Windows 95 Control panel setting changes to take affect.

#### INTERNAL MODEM

Your internal modem is a fax/data/voice modem controlled by Windows 95, LapLink, MegaPhone or other software. The voice functions of the modem include speakerphone and answering machine capabilities. The answering machine capabilities require the use of third party software not included with your notebook. The other features are accessible via Windows 95, LapLink or MegaPhone. This modem is upgradeable to the v.90 standard.

#### INFRARED PORT

Infrared IrDA-compatible communication is a function that allows for wireless data transfer between your notebook and other IrDA-compatible devices. Examples of IrDA-compatible devices are another computer or a printer. When carrying out this kind of

communication, both devices must be set so their infrared ports are directly facing each other without obstructions. A distance of 6" to 36" between the device ports is ideal. Dirt or scratches on the lens of your notebook or the other device will degrade performance. This is especially true for Fast IrDA applications such as a transfer to an Ethernet. Laplink software can be used for Infrared file transfers. (See the Laplink online help for more information.)

 **CAUTION**

Your internal modem is designed to allow faster downloads from K56flex compliant digital sources. Maximum achievable download transmission rates may not reach 56kbps and will vary with line conditions.

 **CAUTION**

Do not move either device during communication as it may interrupt data transmission.

 **CAUTION**

Be careful not to scratch the infrared port lens. Scratches, dirt or other surface marks can effect operation.

The following conditions may interfere with infrared communications:

- When the infrared communication ports are not directly facing each other, or some obstacle is between them.
- When the infrared communication ports are too far apart.
- When a television or radio remote control unit, or a wireless headphone is being used nearby.
- When a strong light such as direct sunlight, fluorescent light, or incandescent light shines on the port.

### PRE-INSTALLED SOFTWARE

Your LifeBook 200 Series comes with pre-installed software for playing audio and video files of various formats. In addition there is file transfer software, telephony software and virus protection software. Some models come with additional application software.

All of the pre-installed software can be accessed from the Program folder of the Windows 95 Start menu or the following folders above the Program folder in the Start menu: Business Software, Communications Software, Multimedia Software, Service and Support Software, and System Management Software.

#### SoftPEG MPEG File Player

The MPEG file player displays a screen to find the file which you wish to play. You can setup the list to select from limited to particular types of files or display all files. Opening the desired file will play it. Online help screens are available for more information. (Located in the Multimedia Software folder.)

#### SoftPEG Video CD Player

This control resembles a VCR player front panel and is operated in the same way. When you point to a button, a small explanation of the use of the button will appear. When you left-click on the button it will activate. Online help screens are available for more information. (Located in the Multimedia Software folder.)

#### ESS AudioRack

The control of the AudioRack player software (AudioRack32) resembles the front panels of a rack of stereo equipment and is operated in much the same way. There is also AudioRack recording software (AudioRecorder). Online help screens are accessible from the AudioDrive panel of AudioRack32; click on the Help button for more information. In the AudioRecorder dialog box, click on Help in the top taskbar.

In AudioRack32 the AudioDrive panel lets you turn on and off the available functions. When you left-click on a button it will activate. When a function is active its button on the AudioDrive shows a green dot and its control

panel is in the equipment rack. When it is off the dot on the button is black and the control panel is not in the rack. You activate a slider or knob on a control panel by dragging it. The functions available are DAT (Digital Audio Tape player), 3D (3D-Stereo sound control), MIDI, Mixer and CD (Audio CD player). (Located in the Multimedia Software folder.)



#### POINT

For maximum frequency response and bandwidth, leave the graphic equalizer levels at the mid-point (zero level). To customize the frequency response to your personal taste, adjust accordingly.



#### CAUTION

The ESS AudioRack volume settings sets the maximum volume level of the hardware volume control knob for that function.

 **CAUTION**

If you use a speakerphone function, be sure that the microphone setting in the ESS AudioRack is disabled.

**LapLink**

**LapLink by Traveling Software provides direct file transfers to other computers; data transfers via internal modem, a PC Card modem, the infrared port, a serial cable, or a parallel cable (cables are not included). See the LapLink online help screens for operating instructions. (Located in the Communications Software folder.)**

**MegaPhone**

**MegaPhone by Cypress Research Corporation is telephony software which provides access to the voice and fax features of your notebook's internal modem. It features dialing, speakerphone and caller ID, and fax functions. See your MegaPhone online help screens for guidance in operating the MegaPhone software. (Located in the Communications Software folder.)**

 **POINT**

For optimum speakerphone performance:

- Speak clearly.
- Limit background noise.
- Speak facing the keyboard from about one (1) foot away.

**McAfee VirusScan**

**Running your McAfee VirusScan program after loading data or programs from a floppy disk, CD-ROM, modem data transfer, or infrared data transfer is a precaution that will protect the data on your hard drive from contamination or destruction. See your VirusScan online help screens for information on how and when to run this program. (Located in the Service and Support Software folder.)**

**PC Doctor**

**PC Doctor by Watergate Software is primarily for use by your support representative when helping you with trouble shooting. (See pages**

**140–141 for more information.) (Located in the Service and Support Software folder.)**

**Quicken 98 Basic**

**Quicken 98 Basic by Intuit is a personal money management program. It has features such as portfolio management, account registeries, on-line banking, and bill paying features. (Located in the Business Software folder.)**

**Microsoft Works**

**Microsoft Works is a suite of software containing the basic tools to write letters and reports, track family and friends with the address book, manage home finances, and create a home inventory. (Located in the Business Software folder.)**

 **POINT**

If you have an active internet connection on your notebook you can access our Service and Support web site by selecting the icon 'Fujitsu Service and Support Web Site' in the Service and Support folder in the Start menu.

**Configuring Your LifeBook 200 Series**

Boot Sequence . . . . .	52
Identifying the Drives. . . . .	52
BIOS Setup Utility . . . . .	53
Navigating Through the Setup Utility . . . . .	55
Main Menu – Setting Standard System Parameters . . . . .	56
Advanced Menu – Setting Device Feature Controls . . . . .	65
Security Menu – Setting the Security Features . . . . .	87
Power Menu – Setting Power Management Feature Controls . . . . .	93
Boot Menu – Selecting the Operating System Source . . . . .	101
Info Menu – Displaying Basic System Information. . . . .	105
Exit Menu – Leaving the Setup Utility. . . . .	107
Setting Up Your Save-To-Disk File Allocation . . . . .	110

## SECTION THREE

### CONFIGURING YOUR LIFEBOOK 200 SERIES FROM FUJITSU

This section explains the BIOS setup utility. The BIOS setup utility is required to set the date, time, power management modes, data security passwords and other operating parameters of your notebook.

#### BOOT SEQUENCE

Each time you power up or restart your LifeBook 200 Series, it goes through a quiet boot sequence that displays a Fujitsu logo until your operating system is loaded. During quiet boot, your notebook is performing a standard boot sequence including a Power On Self Test (POST). To access the ability to change the drive that will be used for finding the operating system, press the Esc key anytime while the Fujitsu logo is displayed. To enter the BIOS setup utility press the F2 key anytime while the Fujitsu logo is displayed. When the boot sequence is completed without a failure and without a request for the setup utility, the

system displays the Windows 95 opening screen. The boot sequence is executed when:

- You turn on power to the system using the power switch on the right side panel of your notebook. (Figure 2-5 on page 23.)
- You restart your computer from the Windows 95 Shutdown dialog box of the Start Menu.
- The software initiates a system restart. Example: When you install a new application.
- You reset the system by pressing the three keys Ctrl+Alt+Del at the same time and then restart your computer from the Windows 95 Shutdown dialog box.



#### POINT

The BIOS setup utility is entered by pressing the **F2** key during the boot process while the Fujitsu logo is on the screen.



#### POINT

When error messages occur see Section Five, pages 138-140, for help in understanding the meaning and required actions to be taken.

#### IDENTIFYING THE DRIVES

Your notebook uses drive letters (Example A:, B:, C:, D:, E:) to identify internal and external devices such as hard drives, floppy disk drives, Zip drives, CD-ROM drives and PC Cards. The most commonly assigned drive designators are listed below. If you add other devices, the drive designators may be different. See your operating system manual for setting drive designations.

##### Drive Designators

##### A: Floppy disk drive.

Installable in either of the multi-function bays of your notebook, or use the external floppy disk drive.

##### B: Not used with your notebook.

- C: Hard drive.**  
Installed inside your notebook.
- D: CD-ROM drive, optional second hard drive or Zip drive.** Installable in Multi-function Bay 2 of your notebook.
- E: Zip Drive if a CD-ROM drive or optional Second hard drive is installed in Multi-function Bay 2 of your notebook.**

**CAUTION**

A bootable CD-ROM may have either a floppy disk format or a hard drive format. When using a bootable CD-ROM, drive designations will automatically change according to which format is used. (See page 63 for more information.)

**BIOS SETUP UTILITY**

The BIOS setup utility is a program that sets the operating environment for your notebook. It is referred to in this publication as the setup utility. There is no need to set or change the

environment to operate as it is set at the factory for normal operating conditions.

The setup utility configures:

- Standard system parameters, such as date and time.
- Device control feature parameters, such as I/O addresses and boot devices.
- Power Management parameters that help to conserve your notebook's batteries.
- System Data Security feature parameters, such as passwords.

You will only have to change the utility settings if you want to:

- Change the date or time. (You can also do this without entering the setup utility, through your operating system. See your operating system manual.)
- Change the primary boot device.
- Change the power management parameter settings. (For a more convenient process, see the PowerPanel on pages 40-43.)

- Change a port address or other parameter.
- Change an audio parameter setting.
- Change the selection of whether to use the built-in display, an external monitor or both. (For a more convenient process, see the Fn key on page 33.)
- Change the system data security settings.

**Routinely Entering the Setup Utility**

You can enter the setup utility whenever you turn on or reset the system. To do this:

1. Allow the system to start booting.
2. As soon as the Fujitsu logo appears on the screen, press the F2 key.
3. The Main menu of the setup utility then appears with the current settings of the parameters displayed.
4. If you wish to go to one of the other setup menus, press the ← or the → key to find the menu you require.

 **POINT**

If your data security settings require it, you may be asked for a password before the Main menu will appear.

**Entering the Setup Utility After a Configuration Change or System Failure**  
If there has been a change in the system configuration that does not agree with the parameter settings stored in your BIOS memory, or there is a failure in the system, the system beeps and/or displays an error message after the Power On Self Test (POST). If the failure is not too severe, it will give you the opportunity to modify the settings of the setup utility, as described in the following steps:

1. When you turn on or restart the computer there is a beep and/or the following message appears on the screen:

Error message - please run SETUP program  
Press <F1> key to continue, <F2> to run SETUP

2. If an error message is displayed on the screen, and you want to continue with the boot process and start the operating system anyway, press the F1 key.

 **CAUTION**

If your notebook beeps a series of beeps that sounds like a code and the display is blank, please refer to the Troubleshooting Section. (See page 135.) The Troubleshooting Section includes a list of error messages and their meanings. (See pages 138-140.)

 **POINT**

If your data security settings require it, you may be asked for a password before the operating system will be opened.

3. If an error message is displayed on the screen, and you want to enter the setup utility, press the F2 key.
4. When the setup utility starts with a fault present, the system displays the following message:

Warning!

Error message

[Continue]

5. Press any key to enter the setup utility. The system will then display the Main Menu with current parameters values.

### NAVIGATING THROUGH THE SETUP UTILITY

The BIOS setup utility consists of seven menus; MAIN, ADVANCED, SECURITY, POWER, BOOT, INFO and EXIT. The remainder of Section Three explains each menu in turn including all submenus and setup items.

The following procedures allow you to navigate the setup utility menus:

1. To select a menu, use the cursor keys: ← , →.
2. To select a field within a menu or a submenu, use the cursor keys: ↑ , ↓.
3. To select the different values for each field, press the Spacebar or + to change to the next higher selection and F5 or - to go to the next lower selection.
4. To activate a submenu press the Enter key.
5. To return to a menu from a submenu, press the Esc key.
6. To go to the Exit menu from any other menu, press the Esc key.
7. Pressing the F9 key resets all items in the current menu to the default values.
8. Pressing the F10 key saves the current configuration and exits the BIOS Setup Utility. You will be asked to verify this selection before it is executed.
9. Pressing the F1 key gives you a general help screen.



#### POINT

Selecting a field causes a help message about that field to be displayed on the right-hand side of the screen



#### POINT

Pressing the **Enter** key with the highlight on a selection that is not a submenu or auto selection will cause a list of all options for that item to be displayed. Pressing the **Enter** key or **Esc** key will select the highlighted choice and remove the list.



#### POINT

The BIOS Setup screens depicted in this manual are only representations of the actual setup screens. The BIOS Setup screens on your notebook may vary.

### MAIN MENU – SETTING STANDARD SYSTEM PARAMETERS

The Main Menu allows you to set or view the current system parameters. Follow the instructions for Navigating Through The Setup Utility to make any changes. (See page 55.)

Table 3-1 shows the names of the menu fields for the Main menu, all of the options for each field, the default settings and a description of the field's function and any special information needed to help understand the field's use.

**POINT**

System Time and System Date can also be set from your operating system without using the setup utility. Use the calendar and time icon on your Control panel for Windows 95 or type time or date from the MS-DOS prompt.

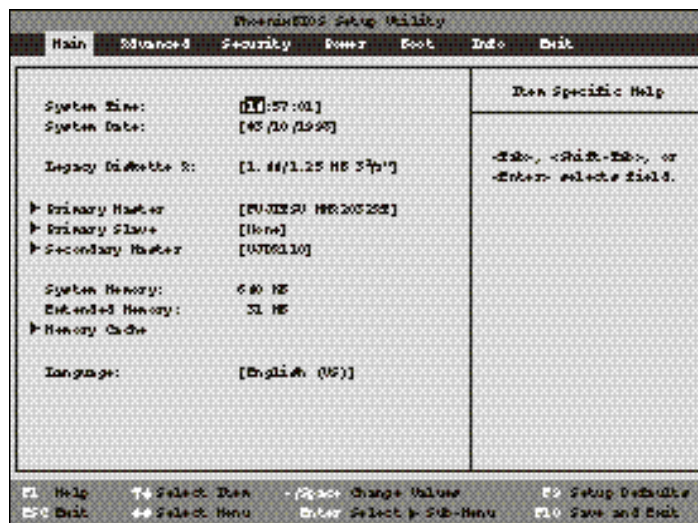


Figure 3-1 Main Menu

Table 3-1 Fields, Options and Defaults for the Main Menu

Menu Field	Options	Default	Description
<b>System Time:</b>	—	—	<b>Sets and displays the current time. Time is in a 24 hour format of hours:minutes:seconds with 2 digits for each.(HH:MM:SS). Example: 16:45:57. You may change each segment of the time separately. Move between the segments with the Tab key and/or Shift + Tab keys.</b>
<b>System Date:</b>	—	—	<b>Sets and displays the current date. Date is in a month/day/year numeric format with 2 digits each for month and day and 4 digits for year. (MM/DD/YYYY) for example: 03/20/1996. You may change each segment of the date separately. Move between the segments with the Tab key and/or Shift + Tab keys.</b>
<b>Legacy Diskette A:</b>	<b>Disabled.</b>	<b>1.44/1.25MB 3.5"</b>	<b>Sets the format for floppy disk drive A if it is installed.</b>
<b>Primary Master:</b>	<b>Selects Primary Master submenu.</b>		<b>Display the type of device on this ATA/ATAPI interface,if there is one. Pressing the Enter key selects the Primary Master submenu allowing additional device configuration options for this interface.</b>
<b>Primary Slave:</b>	<b>Selects Primary Slave submenu.</b>		<b>Display the type of device on this ATA/ATAPI interface,if there is one. Pressing the Enter key selects the Primary Slave submenu allowing additional device configuration options for this interface.</b>

Table 3-1 Fields, Options and Defaults for the Main Menu

Menu Field	Options	Default	Description
<b>Secondary Master:</b>	<b>Selects Secondary Master submenu.</b>	<b>[UJDA110]</b>	<b>Display the type of device on this ATA/ATAPI interface, if there is one. Pressing the Enter key selects the Secondary Master submenu allowing additional device configuration options for this interface.</b>
<b>System Memory:</b>		640 KB	<b>Displays the size of system memory, which is detected automatically and cannot be changed by the setup utility.</b>
<b>Extended Memory:</b>		31 MB	<b>Displays the size of extended memory which is detected automatically and cannot be changed by the setup utility.</b>
<b>Memory Cache:</b>	<b>Selects the memory cache submenu.</b>	—	<b>Allows you to set your system to use external memory cache.</b>
<b>Language:</b>	<b>English (US); Japanese (JP).</b>	<b>[English (US)]</b>	<b>The default setting differs between the US/European and the Japanese model. Selects the display language for the BIOS.</b>

### Configuring Your LifeBook 200 Series

#### Primary Master – Submenu

The Primary Master/Slave, Secondary Master submenus are identical for hard drives. They have the capacity displayed at the top of the screen as well as on Main menu. Follow the instructions for Navigating Through the Setup Utility to make any changes. (See page 55.)

Table 3-2 shows the names of the menu fields for the Primary Master submenu, all of the options for each field, the default settings and a description of the field's function and any special information needed to help understand the field's use.

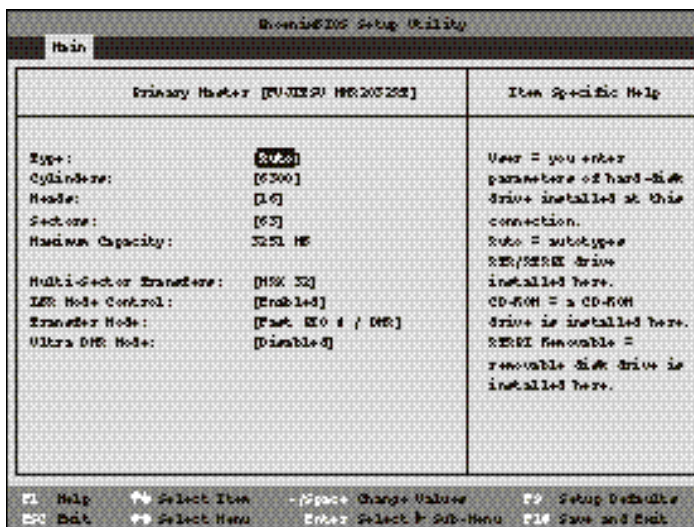


Figure 3-2 Primary Master/Slave, Secondary Master Submenus

Table 3-2 Fields, Options and Defaults for the Primary Master/Slave, Secondary Master Submenus

Menu Field	Options	Default	Description
<b>Type:</b>	<b>Auto; None; CD-ROM; User; ATAPI Removable.</b>	<b>[Auto]</b>	<b>Selects the ATA/ATAPI device type. Select Auto to have the type automatically identified by the BIOS at POST. If None is selected, all of the following Set-up items do not appear. Select CD-ROM if a CD-ROM drive is installed at this connection. If User is selected, you must specify the number of Cylinders, Heads, and Sectors for the drive. Select ATAPI Removable if a removable disk drive is installed at this connection.</b>
<b>Cylinders:</b>	<b>A number between 0 and 65,535.</b>		<b>This item appears only when Auto is selected and the type is identified as hard disk, or User is selected. When User is selected, you can change the value. This field is changed by incrementing (pressing the Spacebar) or by typing in the number.</b>
<b>Heads:</b>	<b>A number between 1 and 16.</b>		<b>This item appears only when Auto is selected and the type is identified as hard disk, or User is selected. When User is selected, you can change the value. This field is changed by incrementing (pressing the Spacebar) or by typing in the number.</b>
<b>Sectors:</b>	<b>A number between 0 and 63.</b>		<b>This item appears only when Auto is selected and the type is identified as hard disk, or User is selected. When User is selected, you can change the value. This field is changed by incrementing (pressing the Spacebar) or by typing in the number.</b>

Table 3-2 Fields, Options and Defaults for the Primary Master/Slave, Secondary Master Submenus

Menu Field	Options	Default	Description
<b>Maximum Capacity:</b>	<b>Display only.</b>	—	<b>Displays the maximum capacity of the drive calculated from the parameters of the hard disk when Auto is selected and the type is identified as hard disk, or User is selected.</b>
<b>Multi-Sector Transfers:</b>	<b>Disabled; 2; 4; 8;16. MAX 32;MAX 64;MAX 128.</b>	—	<b>This option cannot be changed when Auto is selected. Specify the number of sectors per block for multiple sector transfer. MAX refers to the size the disk returns when required.</b>
<b>LBA Mode Control:</b>	<b>Enabled; Disabled.</b>	—	<b>Enables or disables logical Block Addressing in place of Cylinder, Head, Sector addressing. This option cannot be changed when Auto is selected.</b>
<b>Transfer Mode:</b>	<b>Standard, Fast PIO 1; Fast PIO 2; Fast PIO 3; Fast PIO 4; Fast PIO 3 / DMA; Fast PIO 4 / DMA.</b>	—	<b>Selects the method for moving data to/from the drive. Autotype the drive to select the optimum transfer mode. This option cannot be changed when Auto is selected. Multi-word DMA is automatically set to mode 1 for Fast PIO 1, Fast PIO 2, Fast PIO 3, and set to mode 2 for Fast PIO 4 / DMA.</b>
<b>Ultra DMA Mode:</b>	<b>Disabled; Mode 0; Mode 1; Mode 2.</b>	—	<b>Selects the method for moving data to/from the drive. Autotype the drive to select the optimum transfer mode. This option cannot be changed when Auto is selected.</b>



**CAUTION**

A bootable CD-ROM may have either a floppy disk format or a hard drive format. When the bootable CD-ROM is used the drive allocations change automatically without changing the BIOS setup. If a floppy disk format CD-ROM is used the CD-ROM becomes Drive A. If a hard disk format CD-ROM is used the internal hard drive becomes Drive D and the CD-ROM becomes Drive C and all other drive designations shift as necessary. The boot sequence ignores the new drive designations, however, your application software will use the new designations.



**CAUTION**

Be careful of the operating environment when booting from a CD-ROM or you may overwrite files by mistake.

### Configuring Your LifeBook 200 Series

#### Memory Cache – Submenu

The Memory Cache submenu provides the ability to enable or disable external cache memory for your processor. Follow the instructions for Navigating Through the Setup Utility to make any changes. (See page 55.)

Table 3-3 shows the names of the menu fields for the Memory Cache submenu, all the options for each field, the default settings and a description of the field's function and any special information needed to help understand the field's use.

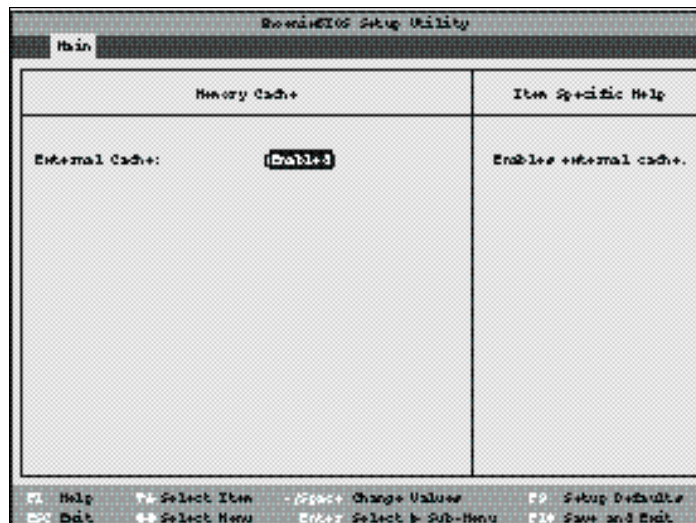


Figure 3-3 Memory Cache Submenu of the Main Menu

Table 3-3 Fields, Options and Defaults for the Memory Cache Submenu

Menu Field	Options	Default	Description
External Cache:	Enabled; Disabled.	[Enabled]	Turns external memory cache on and off.

#### Exiting from the Main Menu

When you have finished setting the parameters on this menu, you can either exit from the setup utility, or move to another menu. If you wish to exit from the setup utility, press the Esc key or use the cursor keys to go to the Exit menu. If you wish to move to another menu, use the cursor keys. (See *Navigating Through the Setup Utility on page 55 for more information.*)

### Configuring Your LifeBook 200 Series

#### ADVANCED MENU – SETTING DEVICE FEATURE CONTROLS

The Advanced Menu allows you to:

- Enable or disable support for Plug & Play operating systems.
- Enable or disable BIOS support for ACPI.
- Set the I/O addresses for the serial and parallel ports.
- Set the communication mode for the parallel port.
- Set an audio function I/O address, interrupt level and DMA channel.
- Select between the display panel and an external CRT display.
- Enable or disable compensation for your display.
- Configure PCI devices in your system.

Follow the instructions for **Navigating Through the Setup Utility** to make any changes. (See page 55.)

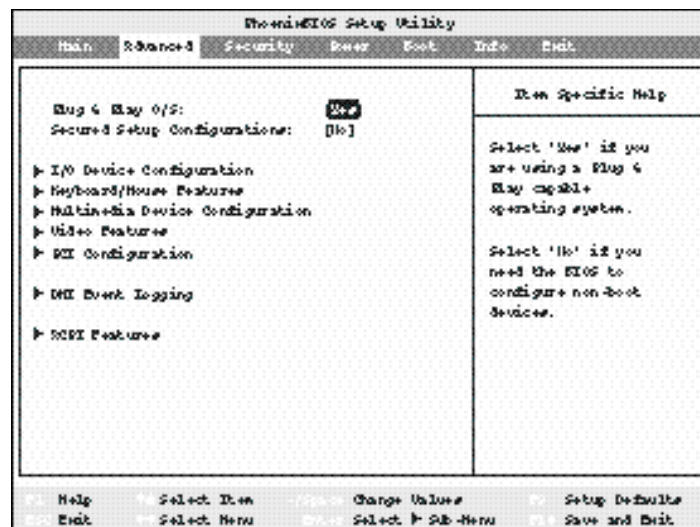


Figure 3-4 Advanced Menu

Table 3-4 shows the names of the menu fields for the Advanced Menu, all of the options for each field, the default settings and a description

of the field's function and any special information needed to help understand the field's use.

Table 3-4 Field Names, Options and Defaults for the Advanced Menu

Menu Field	Options	Default	Description
<b>Plug &amp; Play O/S:</b>	<b>Yes; No.</b>	<b>[Yes]</b>	<b>Select Yes if you are using a Plug &amp; Play capable operating system. Select No if you need the BIOS to configure non-boot devices.</b>
<b>Secured Setup Configuration:</b>	<b>Yes; No.</b>	<b>[No]</b>	<b>Yes prevents a Plug &amp; Play operating system from changing system settings.</b>
<b>I/O Device Configuration:</b>			<b>When selected, opens the I/O Device Configuration submenu which allows the user to modify settings for parallel and serial ports, the floppy disk controller, and the local bus IDE adapter.</b>
<b>Keyboard/Mouse Features:</b>			<b>When selected, opens the Keyboard/Mouse Features submenu, which allows setting external and internal keyboard and mouse parameters.</b>
<b>Multimedia Device Configuration:</b>			<b>When selected, opens the Multimedia Device Configuration submenu, which allows setting the hardware address and interrupt levels of audio functions and enabling or disabling the MIDI/joystick port.</b>
<b>Video Features:</b>			<b>When selected, opens the Video Features submenu, which allow setting of the display parameters, including routing of video signals to different displays.</b>

Table 3-4 Field Names, Options and Defaults for the Advanced Menu

Menu Field	Options	Default	Description
<b>PCI Configuration:</b>			<b>When selected, opens additional menus to configure PCI devices.</b>
<b>DMI Event Logging:</b>			<b>When selected, opens the DMI event logging configuration menu.</b>
<b>ACPI Features:</b>			<b>When selected, opens the ACPI features menu, which allows enabling and disabling ACPI BIOS.</b>

### CAUTION

I/O addresses, DMA channels and Interrupt levels can be entered in various ways, including via the BIOS setup utility, the control software for the I/O device, or the hardware. If any two ports or devices, serial or parallel, have the same I/O address assigned your notebook will not function normally. Please keep a record of original settings before making any changes in the event that a restoration is required. See your hardware and software documentation as well as the setup utility to determine settings, limitations, etc.

#### I/O Device Configuration

##### Submenu of the Advanced Menu

The I/O Device Configuration submenu provides the ability to set the I/O addresses and interrupt levels for the parallel and serial ports, and disk drive controllers of your notebook.

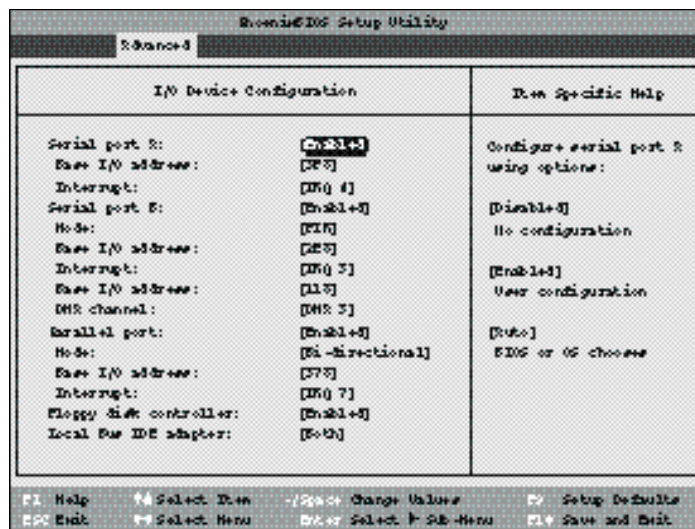


Figure 3-5 I/O Device Configuration Submenu

Follow the instructions for Navigating Through the Setup Utility to make any changes. (See page 55.)

**Configuring Your LifeBook 200 Series****CAUTION**

The BIOS will warn you if there is a resource conflict by placing a yellow asterisk next to the device(s) reporting (a) conflict.

**Table 3-5 shows the names of the menu fields for the I/O Device Configuration submenu, all of the options for each field, the default settings and a description of the field's function and any special information needed to help understand the field's use.**

**POINT**

To prevent IRQ and address conflicts, avoid changing the default settings. If you must change the settings, you can call 1-800-8FUJITSU for technical assistance.

**POINT**

All I/O addresses in Table 3-5 are in hexadecimal.

Table 3-5 Fields, Options and Defaults for the I/O Device Configuration Submenu of the Advanced Menu

Menu Field	Options	Default	Description
<b>Serial Port A:</b>	<b>Disabled;Enabled; Auto.</b>	<b>[Enabled]</b>	<b>Configures the serial port A using either no configuration (Disabled),a user defined configuration (Enabled), or by allowing the BIOS or OS to choose the configuration (Auto).</b>
<b>Base I/O address:</b>	<b>3F8; 2F8; 3E8;2E8.</b>	<b>[3F8]</b>	<b>Allows user to set the serial port base I/O address when port A is Enabled.</b>
<b>Interrupt:</b>	<b>IRQ 3; IRQ 4; IRQ 10; IRQ 11.</b>	<b>[IRQ 4]</b>	<b>Allows user to set the serial port interrupt when port A is Enabled.</b>
<b>Serial Port B:</b>	<b>Disabled;Enabled; Auto.</b>	<b>[Enabled]</b>	<b>Configures the serial port A using either no configuration (Disabled),a user defined configuration (Enabled), or by allowing the BIOS or OS to choose the configuration (Auto).</b>
<b>Mode:</b>	<b>IrDA; FIR.</b>	<b>[FIR]</b>	<b>Allows user to set the serial port mode when port B is Enabled.</b>
<b>Base I/O address:</b>	<b>3F8;2F8; 3E8;2E8.</b>	<b>[2E8]</b>	<b>Allows user to set the serial port base I/O address when port B is Enabled.</b>

Table 3-5 Fields, Options and Defaults for the I/O Device Configuration Submenu of the Advanced Menu

Menu Field	Options	Default	Description
<b>Interrupt:</b>	<b>IRQ 3; IRQ 4; IRQ 10; IRQ 11.</b>	<b>[IRQ 3]</b>	<b>Allows user to set the serial port interrupt when port B is Enabled.</b>
<b>Base I/O address:</b>	<b>100; 108;110; 118.</b>	<b>[118]</b>	<b>When the mode for serial port B is set to FIR,this option is available allowing the user to set the base I/O address for the FIR of serial port B.</b>
<b>DMA channel:</b>	<b>DMA 1;DMA 3.</b>	<b>[DMA 3]</b>	<b>When the mode for serial port B is set to FIR,this option is available allowing the user to set the DMA channel for the FIR of serial port B.</b>
<b>Parallel port:</b>	<b>Disabled;Enabled; Auto.</b>	<b>[Enabled]</b>	<b>Configures the parallel port using either no configuration (Disabled),a user defined configuration (Enabled), or by allowing the BIOS or OS to choose the configuration (Auto).</b>
<b>Mode:</b>	<b>Output Only; Bi-directional; ECP.</b>	<b>[Bi-directional]</b>	<b>When the parallel port is enabled this option is available allowing the user to set the mode for the parallel port. Bi-directional allows two-way transfer of information between your notebook and a connected parallel device. Output Only (Half Duplex) allows information to be transferred in only one direction, from your notebook to the printer or similar device.ECP Mode allows communication with the ECP class of parallel I/O devices.</b>

Table 3-5 Fields, Options and Defaults for the I/O Device Configuration Submenu of the Advanced Menu

Menu Field	Options	Default	Description
<b>Base I/O address:</b>	<b>378; 278;3BC.</b>	<b>[378]</b>	<b>Allows user to set the parallel port base I/O address when the parallel port is Enabled.</b>
<b>Interrupt:</b>	<b>IRQ 5; IRQ 7.</b>	<b>[IRQ 7]</b>	<b>Allows user to set the parallel port interrupt when the parallel port is Enabled.</b>
<b>Floppy disk controller:</b>	<b>Disabled;Enabled; Auto.</b>	<b>[Enabled]</b>	<b>Enables and disables the floppy disk drive controller for both multi-function bays and the external floppy disk drive port. When Auto is selected,allows the BIOS to choose the configuration for the controller.</b>
<b>Local Bus IDE adapter:</b>	<b>Both; Disabled; Primary; Secondary.</b>	<b>[Both]</b>	<b>Enables and disables the integrated local bus IDE adapter.</b>

### Configuring Your LifeBook 200 Series

#### Keyboard/Mouse Features Submenu

The Keyboard/Mouse Features submenu is for setting the parameters of the integrated and external mouse and keyboard. Follow the instructions for Navigating Through the Setup Utility to make any changes. (See page 55.)

Table 3-6 shows the names of the menu fields for the Keyboard/Mouse submenu, all of the options for each field, the default settings and a description of the field's function and any special information needed to help understand the field's use.

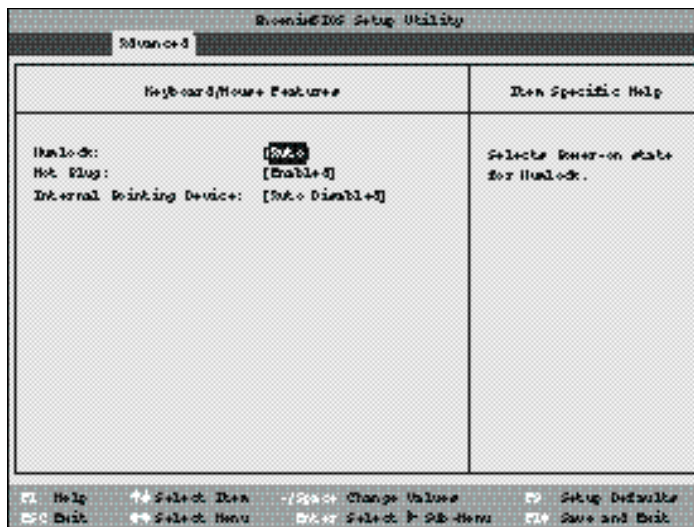


Figure 3-6 Keyboard/Mouse Features Submenu

Table 3-6 Fields, Options and Defaults of the Keyboard/Mouse Submenu of the Advanced Menu

Menu Field	Options	Default	Description
<b>Numlock:</b>	<b>Off; On; Auto.</b>	<b>[Auto]</b>	<b>Sets the NumLock function state when the computer completes booting.</b>
<b>Hot Plug:</b>	<b>Enabled; Disabled.</b>	<b>[Enabled]</b>	<b>Enables and disables the ability to plug a mouse or keyboard into the PS/2 port and have it immediately recognized and active.</b>
<b>Internal Pointing Device:</b>	<b>Auto Disabled; Always Enabled.</b>	<b>[Auto Disabled]</b>	<b>Sets the device controlling the mouse cursor on the screen. Always Enabled makes the ErgoTrac pointing device always enabled whether there is an external mouse or not. Auto Disabled makes the ErgoTrac pointing device turn off when an external pointing device is connected to the PS/2 port.</b>

### Configuring Your LifeBook 200 Series

**Multimedia Device Configuration Submenu**  
The Multimedia Device Configuration submenu is for setting the features of the built-in audio functions, and enabling joystick function. Follow the instructions for Navigating Through the Setup Utility to make any changes. (See page 55.)

Table 3-7 shows the names of the menu fields for the Multimedia Device Configuration submenu, all of the options for each field, the default settings and a description of the field's function and any special information needed to help understand the field's use.



#### POINT

All I/O addresses in Table 3-7 are in hexadecimal.

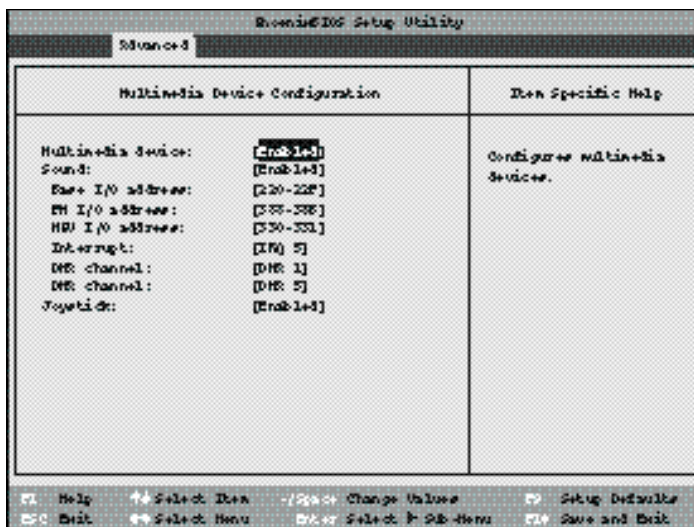


Figure 3-7 Multimedia Device Configuration Submenu

Table 3-7 Fields, Options and Defaults of the Multimedia Device Configuration Submenu of the Advanced Menu

Menu Field	Options	Default	Description
<b>Multimedia device:</b>	<b>Disabled; Enabled.</b>	<b>[Enabled]</b>	<b>Enables or disables BIOS support for sound and joystick operation. If Disabled, none of the following items will appear.</b>
<b>Sound:</b>	<b>Disabled; Enabled; Auto.</b>	<b>[Enabled]</b>	<b>Allows BIOS support for sound to be enabled or disabled. When set to Auto, the BIOS or OS will choose the proper sound configuration settings and some of the following items will not appear.</b>
<b>Base I/O address:</b>	<b>220-22F; 240-24F; 260-26F; 280-28F.</b>	<b>[220-22F]</b>	<b>When Sound is Enabled, this option is available allowing the user to set the base I/O address for the sound device.</b>
<b>FM I/O address:</b>	<b>388-38B;38C-38F; 390-393;394-397.</b>	<b>[388-38B]</b>	<b>When Sound is Enabled, this option is available allowing the user to set the base I/O address for the FM device.</b>
<b>MPU-I/O address:</b>	<b>300-301; 310-311; 320-321;330-331.</b>	<b>[330-331]</b>	<b>When Sound is Enabled, this option is available allowing the user to set the I/O address for the MPU.</b>
<b>Interrupt:</b>	<b>IRQ 5;IRQ 7; IRQ 9; IRQ 10; IRQ 11.</b>	<b>[IRQ 5]</b>	<b>When Sound is Enabled, this option is available allowing the user to set the interrupt for the sound device.</b>
<b>DMA channel:</b>	<b>DMA 0; DMA 1; DMA 3; DMA 5.</b>	<b>[DMA 1]</b>	<b>When Sound is Enabled, this option is available allowing the user to set the DMA channel for the sound device.</b>
<b>DMA channel:</b>	<b>DMA 0; DMA 1; DMA 3; DMA 5.</b>	<b>[DMA 5]</b>	<b>When Sound is Enabled, this option is available allowing the user to set the DMA channel for the sound device.</b>
<b>Joystick:</b>	<b>Disabled; Enabled.</b>	<b>[Enabled]</b>	<b>Enables or disables BIOS support for the joystick.</b>

### Configuring Your LifeBook 200 Series

#### Video Features Submenu

The Video Features Submenu is for setting the display parameters. Follow the instructions for Navigating Through the Setup Utility to make any changes. (See page 55.)

Table 3-8 shows the names of the menu fields for the Video Features submenu, all of the options for each field, the default settings and a description of the field's function and any special information needed to help understand the field's use.

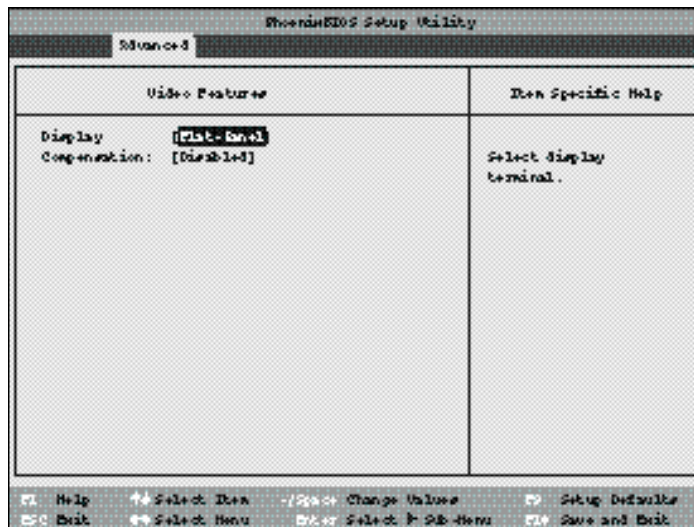


Figure 3-8 Video Features Submenu

Table 3-8 Fields, Options and Defaults for the Video Features Submenu of the Advanced Menu

Menu Field	Options	Default	Description
<b>Display:</b>	<b>Flat-Panel; CRT; Simultaneous.</b>	<b>[Flat-Panel]</b>	<b>Selects where the video signal will be routed.</b>
<b>Compensation:</b>	<b>Enabled; Disabled.</b>	<b>[Disabled]</b>	<b>Enables or disables compensation which controls spacing on the display. When Enabled displays with less than 800 x 600 pixel resolution will still cover the entire screen.</b>

### Configuring Your LifeBook 200 Series

#### PCI Configuration Submenu

The PCI Configuration submenu allows the user to reserve specific interrupts (IRQs) for legacy ISA devices, and to enable or disable built in PCI device modules. Follow the instructions for Navigating Through the Setup Utility to make any changes. (See page 55.)

Table 3-9 shows the names of the menu fields for the PCI Configuration submenu, all of the options for each field, the default settings and a description of the field's function and any special information needed to help understand the field's use.

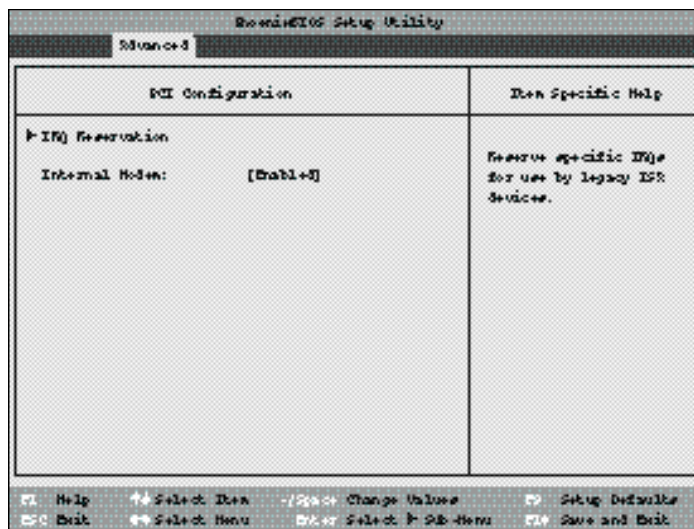


Figure 3-9 PCI Configuration Submenu

Table 3-9 Fields, Options and Defaults for the PCI Configuration Submenu of the Advanced Menu

Menu Field	Options	Default	Description
<b>IRQ Reservation:</b>	—	—	<b>Accesses a submenu allowing the user to reserve specific IRQs for use by legacy ISA devices.</b>
<b>Internal Modem:</b>	<b>Disabled; Enabled.</b>	<b>[Enabled]</b>	<b>Allows the internal modem module to be enabled or disabled.</b>

### Configuring Your LifeBook 200 Series

#### IRQ Reservation Submenu of the PCI Configuration Submenu

The IRQ Reservation submenu of the PCI Configuration submenu allows the user to mark various IRQs as reserved for use by legacy ISA devices. When an IRQ is reserved, the BIOS does not use it for embedded PCI or ISA devices. Follow the instructions for Navigating Through the Setup Utility to make any changes. (See page 55.)

Table 3-10 shows the names of the menu fields for the IRQ Reservation submenu of the PCI Configuration submenu, all of the options for each field, the default settings and a description of the field's function and any special information needed to help understand the field's use.

Advanced		Run Specific Help
IRQ Reservation		
IRQ 3:	[Available]	Reserve the specified IRQ for use by legacy ISA devices.
IRQ 4:	[Available]	
IRQ 5:	[Available]	
IRQ 7:	[Available]	
IRQ 9:	[Available]	
IRQ 10:	[Available]	
IRQ 11:	[Available]	
F1 Help	↑ Select Item	→/Space Change Value
Esc Exit	← Select Menu	Enter Select Sub-Menu
		F5 Setup Defaults
		F10 Save and Exit

Figure 3-10 IRQ Reservation Submenu

Table 3-10 Fields, Options and Defaults for the IRQ Reservation Submenu of the of the PCI Configuration Submenu of the Advanced Menu

Menu Field	Options	Default	Description
<b>IRQ 3:</b>	<b>Available; Reserved.</b>	<b>[Available]</b>	<b>Reserves IRQ 3. If Reserved is selected, the BIOS reserves IRQ 3 for use by legacy ISA devices and does not use it for embedded PCI or ISA devices. IRQ 3 is removed from the IRQ bitmap in the PCI IRQ routing table.</b>
<b>IRQ 4:</b>	<b>Available; Reserved.</b>	<b>[Available]</b>	<b>Reserves IRQ 4.</b>
<b>IRQ 5:</b>	<b>Available; Reserved.</b>	<b>[Available]</b>	<b>Reserves IRQ 5.</b>
<b>IRQ 7:</b>	<b>Available; Reserved.</b>	<b>[Available]</b>	<b>Reserves IRQ 7.</b>
<b>IRQ 9:</b>	<b>Available; Reserved.</b>	<b>[Available]</b>	<b>Reserves IRQ 9.</b>
<b>IRQ 10:</b>	<b>Available; Reserved.</b>	<b>[Available]</b>	<b>Reserves IRQ 10.</b>
<b>IRQ 11:</b>	<b>Available; Reserved.</b>	<b>[Available]</b>	<b>Reserves IRQ 11.</b>

**CAUTION**

Only IRQ's 9, 10, & 11 can be reserved without resource conflict.

### Configuring Your LifeBook 200 Series

#### DMI Event Logging Submenu of the Advanced Menu

The DMI Event Logging Submenu is for setting up the logs DMI event logging. Follow the instructions for Navigating Through the Setup Utility to make any changes. (See page 55.)

Table 3-11 shows the names of the menu fields for the DMI Event Logging submenu, all the options for each field, the default settings and a description of the field's function and any special information needed to help understand the field's use.

DMI Event Logging		Item Specific Help
Event log capacity:	Space Available+	'Yes' clears all DMI event logs at next boot. The value is reset to 'No' after clearing logs.
Event log validity:	Valid	
Clear all DMI event logs:	[No]	
Event Logging:	[Enabled]	
System Boot Event:	[Disabled]	

F1 Help    ↑ Select Item    / Space Change Value    F9 Setup Defaults  
 ESC Exit    ← Select Menu    Enter Select & Sub-Menu    F10 Save and Exit

Figure 3-11 DMI Event Logging Submenu

Table 3-11 Fields, options and Defaults for the DMI Event Logging Submenu

Menu Field	Options	Default	Description
<b>Event log capacity:</b>	<b>Display only.</b>	<b>[Space Available]</b>	
<b>Event log validity:</b>	<b>Display only.</b>	<b>[Valid]</b>	
<b>Clear all DMI event logs:</b>	<b>Yes; No.</b>	<b>[No]</b>	<b>A Yes selection causes the event logs to clear at the next boot. Once the logs are cleared this automatically sets to No until reset to yes by selecting yes here.</b>
<b>Event Logging:</b>	<b>Enabled; Disabled.</b>	<b>[Enabled]</b>	<b>Turns event logging on and off for all DMI events.</b>
<b>System Boot Event:</b>	<b>Enabled; Disabled.</b>	<b>[Disabled]</b>	<b>Turns event logging on and off for DMI system boot events.</b>

### Configuring Your LifeBook 200 Series

#### ACPI Features Submenu of the Advanced Menu

The ACPI Features Submenu is for setting up the Windows 98 Advanced Configuration and Power Interface parameters. Follow the instructions for Navigating Through the Setup Utility to make any changes. (See page 55.)

Table 3-12 shows the names of the menu fields for the ACPI Features submenu, all the options for each field, the default settings and a description of the field's function and any special information needed to help understand the field's use.

ACPI Features		Then Specific Help
Enable ACPI:	[New]	Enable ACPI (Advanced Configuration and power Interface) BIOS.

F1 Help    ← Select Item    -/Space Change Values    F2 Setup Defaults  
 Esc Exit    ← Select Menu    Enter Select P-Sub-Menu    F10 Save and Exit

Figure 3-12 ACPI Features Submenu

Table 3-12 Fields, options and Defaults for the ACPI Features Submenu

Menu Field	Options	Default	Description
Enable ACPI:	Yes; No.	[Yes]	<b>Turns on and off the Advanced Configuration and Power Interface.</b>

#### Exiting from the Advanced Menu

**When you have finished setting the parameters on the Advanced Menu, you can either exit from setup utility or move to another menu. If you wish to exit from setup utility, press the Esc key to go to the Exit menu. If you wish to move to another menu, use the cursor keys.**



#### **POINT**

ACPI features in your notebook will not be available until Windows 98.

### Configuring Your LifeBook 200 Series

#### SECURITY MENU – SETTING THE SECURITY FEATURES

The Security menu allows you to set up the data security features of your notebook to fit your operating needs and to view the current data security configuration. Follow the instructions for Navigating Through the Setup Utility to make any changes. (See page 55.)

Table 3-13 shows the names of the menu fields for the Security menu, all of the options for each field, the default settings and a description of the field's function and any special information needed to help understand the field's use. The default condition is no passwords required and no write protection.

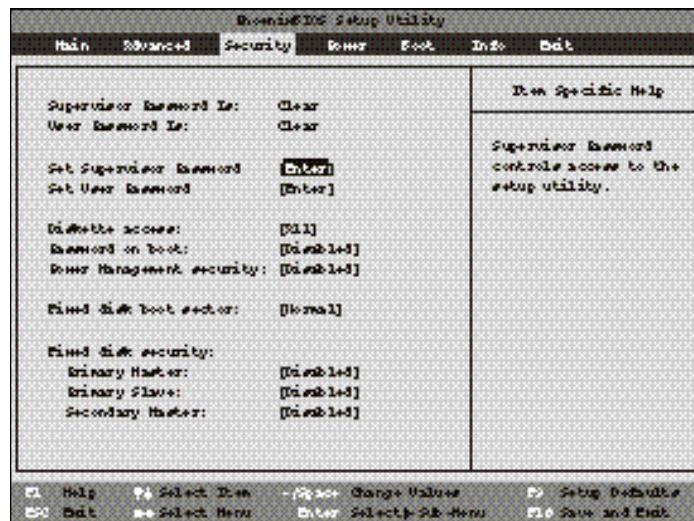


Figure 3-13 Security Menu



**POINT**

If you set a password, write it down and keep it in a safe place. If you forget the password you will have to contact your support representative to regain access to your secured functions and data.



**CAUTION**

Entering a password incorrectly 3 times in a row will cause the keyboard and mouse to be locked out and the warning [System Disabled] to be displayed. If this happens restart the computer by turning off and on the power with the power switch and use the correct password on reboot.



**POINT**

If you make an error when re-entering the password a [Warning] will be displayed on the screen. To try again press the **Enter** key and then retype the password. Press the **Esc** key to abort the password setting process.



**CAUTION**

If the Power Management Security is Enabled and the Password on Boot is Disabled you will not be able to resume operation from the Suspend or Save-to-Disk modes.

Table 3-13 Fields, Options and Defaults for the Security Menu

Menu Field	Options	Default	Description
<b>Supervisor Password is:</b>	—	<b>Clear.</b>	<b>A display-only field. Set is displayed when the system supervisor password is set and Clear when it is not.</b>
<b>User Password is:</b>	—	<b>Clear.</b>	<b>A display-only field. Set is displayed when the general user password is set, and Clear when it is not.</b>
<b>Set Supervisor Password:</b>	<b>[Enter]</b>	—	<b>Sets, changes or cancels the Supervisor Password. The Supervisor Password may be up to seven characters long and must include only lower-case letters or numbers. To cancel a password press the Enter key instead of entering characters in the Enter New Password field and in the Re-enter New Password field. When a Supervisor Password is set it must be used to access the BIOS setup utility.</b>
<b>Set User Password:</b>	<b>[Enter]</b>	—	<b>(This field can only be accessed if the Supervisor Password is set.) Sets, changes or cancels the User Password. The User Password may be up to seven characters long and must include only lower case letters or numbers. To cancel a password press the Enter key instead of entering characters in the Enter New Password field and in the Re-enter New Password field. When a User Password is set it must be used to access the BIOS setup utility.</b>

Table 3-13 Fields, Options and Defaults for the Security Menu

Menu Field	Options	Default	Description
<b>Diskette access:</b>	<b>All; Supervisor Only.</b>	<b>All</b>	<b>Sets the floppy disk access to be secured for access only with Supervisor's password or by all users with a password. The default is all users with a password.</b>
<b>Password on boot:</b>	<b>Enabled; Disabled.</b>	<b>Disabled</b>	<b>When set to Enabled, a password (User or Supervisor) is required after the Power On Self Test (POST) before the operating system will be read from a disk. When set to Disabled no password is required. If no Supervisor Password is set this feature is not available and no password is required.</b>
<b>Power Management Security:</b>	<b>Enabled; Disabled.</b>	<b>Disabled</b>	<b>When set to Enabled, a password (User or Supervisor) is required to resume from Suspend or Save-to-Disk mode. The password required is the same one required by the Password on Boot function.</b>
<b>Fixed disk boot sector:</b>	<b>Normal; Write Protect.</b>	<b>[Normal]</b>	<b>Sets write protection for the sector of the boot disk which contains the operating system. When set to Write Protect, the BIOS will prevent any application from writing into the sector of the internal hard drive containing the operating system. When set to Normal there is no BIOS protection of the operating system.</b>

Table 3-13 Fields, Options and Defaults for the Security Menu

Menu Field	Options	Default	Description
<b>Fixed disk security:</b>	—	—	—
<b>Primary Master:</b>	<b>Enabled; Disabled.</b>	<b>[Disabled]</b>	<b>When set to Enabled ,a password (User or Supervisor) is required to access data on the disk drive on the Primary Master interface.</b>
<b>Primary Slave:</b>	<b>Enabled; Disabled.</b>	<b>[Disabled]</b>	<b>When set to Enabled,a password (User or Supervisor) is required to access data on the Primary Slave interface.</b>
<b>Secondary Master:</b>	<b>Enabled; Disabled.</b>	<b>[Disabled]</b>	<b>When set to Enabled ,a password (User or Supervisor) is required to access data on the disk drive on the Secondary Master interface.</b>



**POINT**

Boot sector protection must be set to [Normal] to install or upgrade an operating system.

**Exiting from the Security Menu**

**When you have finished setting the parameters on the Security Menu, you can either exit from setup utility or move to another menu. If you wish to exit from setup utility, press the Esc key to go to the Exit Menu. If you wish to move to another menu, use the cursor keys.**

## Configuring Your LifeBook 200 Series

### POWER MENU – SETTING POWER MANAGEMENT FEATURE CONTROLS

The Power menu allows you to set and change the power management parameters. Follow the instructions for Navigating Through the Setup Utility to make any changes. (See page 55.)

Table 3-14 shows the names of the menu fields for the Power menu, all of the options for each field, the default settings and a description of the field's function and any special information needed to help understand the field's use.



#### POINT

Most power management parameters which are BIOS related can be set from PowerPanel by Phoenix Technologies. Changing PowerPanel's own profiles does not change what is stored in the CMOS memory.

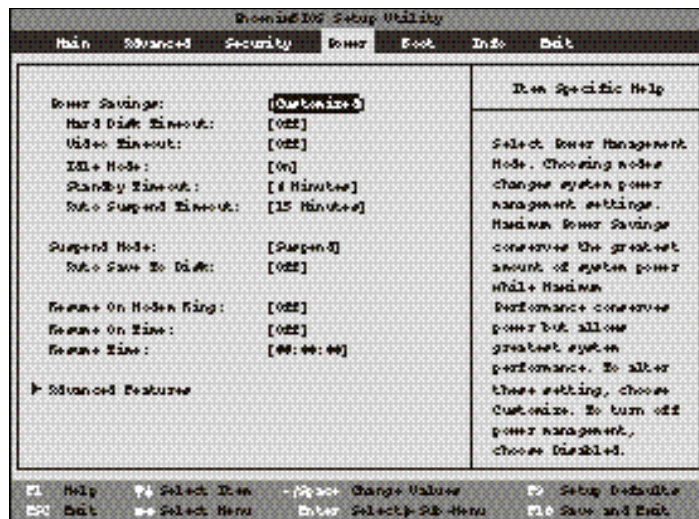


Figure 3-14 Power Menu

Table 3-14 Fields, Options and Defaults for the Power Menu.

Menu Field	Options	Default	Description
<b>Power Savings:</b>	<b>Customized; Maximum Performance; Maximum Power Savings, Disabled.</b>	<b>[Customized]</b>	<b>Sets the power savings parameters to a factory installed combination of parameters, a custom set of parameters set by you or no power saving features.</b>
<b>Hard Disk Timeout:</b>	<b>30 seconds to 20 minutes; Off.</b>	<b>[Off]</b>	<b>Sets the length of time that the hard drive can be inactive before your notebook automatically turns off the power to the hard drive controller and drive motor. If you choose a factory installed combination of parameters this field will display the setting. If you choose to customize the parameters you will be able to set this yourself. The options available vary from Off, which has no inactivity shutoff, to 20 minutes.</b>
<b>Video Timeout:</b>	<b>2 minutes to 20 minutes; Off.</b>	<b>[Off]</b>	<b>Sets the length of time without any user input device activity before the display is turned off. If you choose a factory combination of parameters, this field will display the setting. If you choose to customize the parameters, you will be able to set this yourself. Off has no inactivity shutoff.</b>
<b>Idle Mode:</b>	<b>On; Off.</b>	<b>[On]</b>	<b>Turns on and off the slow down of the CPU during periods of inactivity. When this is turned on the CPU clock slows by the amount set in the Advanced submenu when there is no activity for 16 seconds or more. Normal speed resumes automatically as soon as there is any activity.</b>

Table 3-14 Fields, Options and Defaults for the Power Menu.

Menu Field	Options	Default	Description
<b>Standby Timeout:</b>	<b>1 minute to 16 minutes; Off.</b>	<b>[4 Minutes]</b>	<b>Sets the length of time without any user input device activity before the CPU is set to half speed and the display and the hard drive are turned off. If you choose a factory combination of parameters this field will display the setting. If you choose to customize the parameters you will be able to set this yourself.</b>
<b>Auto Suspend Timeout:</b>	<b>5 to 60 minutes; Off.</b>	<b>[15 Minutes]</b>	<b>Sets the length of time without any I/O activity before your notebook goes into Suspend mode. If you choose a factory combination of parameters this field will display that setting. If you choose to customize the parameters you will be able to set this yourself. Off has no inactivity suspension.</b>
<b>Suspend Mode:</b>	<b>Suspend; Save-to-Disk.</b>	<b>[Suspend]</b>	<b>Sets the form of suspension state. If you choose Suspend, you will suspend operation with power to system memory, and everything else powered down or in a very low power state. If you choose Save-to-Disk your notebook will save all of system memory and the operating parameters to the hard drive before turning your notebook to the pseudo-off condition.</b>



**POINT**

When resuming from a Save-to-Disk suspension there will be a delay while the contents of system memory and operating parameters are loaded from the hard drive.



**CAUTION**

In Save-to-Disk mode there is no indication on the Status Indicator to let you know you are suspended rather than shut off from the power switch. You may want to make a habit of always trying the Suspend/Resume button before using the power switch.

Table 3-14 Fields, Options and Defaults for the Power Menu.

Menu Field	Options	Default	Description
<b>Auto Save to Disk:</b>	<b>Off; After 1 Hour.</b>	<b>[Off]</b>	<b>When set to After 1 Hour your notebook will automatically save all of system memory and the operating parameters to the hard drive and go to the pseudo-off if you leave your notebook in Suspend mode for an hour.</b>
<b>Resume On Modem Ring:</b>	<b>On; Off.</b>	<b>[Off]</b>	<b>Sets whether or not to Resume from a suspension state when a message is received by telephone line. This feature is not available if the Save-to-Disk mode is enabled. This feature applies to internal, external and PC Card modems.</b>
<b>Resume On Time:</b>	<b>On;Off.</b>	<b>[Off]</b>	<b>Sets whether or not to resume from a suspension state at a designated time. This feature is available from either the Suspend mode or the Save-to-Disk mode.</b>
<b>Resume Time:</b>	–	–	<b>Sets the designated time, on a 24-hour clock, when the notebook is to automatically resume operation from the Suspend state. The format of the clock setting is hours:minutes:seconds. Each segment of the time is set separately, either by incrementing or by typing in the numbers. You move between the segments with the Tab key or the Shift+Tab keys. This only applies when Resume on Time is set to On.</b>
<b>Advanced Features:</b>	–	–	<b>When selected, opens the Advanced Features submenu which allows setting additional power saving parameters.</b>

Factory Installed Values for Power Saving Profiles

	Hard Disk Timeout	Video Timeout	Idle Mode	Standby Timeout	Auto Suspend Timeout
<b>Customized:</b>	<b>Off</b>	<b>Off</b>	<b>On</b>	<b>4 Minutes</b>	<b>15 Minutes</b>
<b>Maximum Power Savings:</b>	<b>30 Seconds</b>	<b>2 Minutes</b>	<b>On</b>	<b>1 Minute</b>	<b>5 Minutes</b>
<b>Maximum Performance:</b>	<b>Off</b>	<b>Off</b>	<b>Off</b>	<b>Off</b>	<b>15 Minutes</b>
<b>Disabled:</b>	<b>Off</b>	<b>Off</b>	<b>Off</b>	<b>Off</b>	<b>Off</b>
<b>Sample Customized Profile: (To get even better battery life keep the display and volume settings as low as possible and use the custom setting to set the parameters as shown.)</b>	<b>2 Minutes</b>	<b>1 Minute</b>	<b>On</b>	<b>1 Minute</b>	<b>5 Minutes</b>

### Configuring Your LifeBook 200 Series

#### Advanced Features Submenu of the Power Menu

The Advanced Features submenu is for setting some non-time related power saving parameters. Follow the instructions for Navigating Through the Setup Utility to make any changes. (See page 55.)

Table 3-15 shows the names of the menu fields for the Video Features submenu, all of the options for each field, the default settings and a description of the field's function and any special information needed to help understand the field's use.

#### Exiting from the Power Menu

When you have finished setting the parameters on the Power menu, you can either exit from the Setup utility or move to another menu. If you wish to exit from Setup utility press the Esc key to go to the Exit menu. If you wish to move to another menu, use the cursor keys.

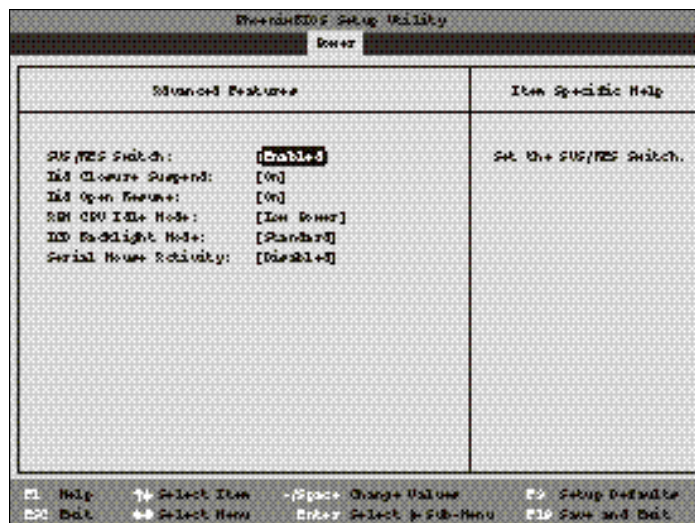


Figure 3-15 Advanced Features Submenu

Table 3-15 Fields, Options and Defaults for the Advanced Features Submenu of the Power Menu

Menu Field	Options	Default	Description
<b>SUS/RES Switch:</b>	<b>Enabled; Disabled.</b>	<b>[Enabled]</b>	<b>Sets the function of the Suspend/Resume button when your notebook is in an active state. The resume function can not be disabled as it works regardless of any other settings.</b>
<b>Lid Closure Suspend:</b>	<b>On; Off.</b>	<b>[On]</b>	<b>Enables and disables having closure of the Display panel put your notebook in Suspend mode.</b>
<b>Lid Open Resume:</b>	<b>On; Off.</b>	<b>[On]</b>	<b>Enables and disables having opening the Display panel acting as an automatic resume.</b>
<b>APM CPU Idle Mode:</b>	<b>Low Power; Standard.</b>	<b>[Low Power]</b>	<b>Sets the CPU speed during Idle mode.</b>
<b>LCD Backlight Mode:</b>	<b>Low Power; Standard.</b>	<b>[Standard]</b>	<b>Sets the CPU speed during Video timeout and Lid Closure Suspend activation.</b>
<b>Serial Mouse Activity:</b>	<b>Enabled; Disabled.</b>	<b>[Disabled]</b>	<b>Enables and disables having activity on the serial port cause the system to reactivate from inactivity timeouts.</b>

### Configuring Your LifeBook 200 Series

#### BOOT MENU – SELECTING THE OPERATING SYSTEM SOURCE

The Boot Menu is used to select the order in which the BIOS searches sources for the operating system.

Table 3-16 shows the names of the menu fields for the Boot menu, all of the options for each field, the default settings and a description of the field's function and any special information needed to help understand the field's use

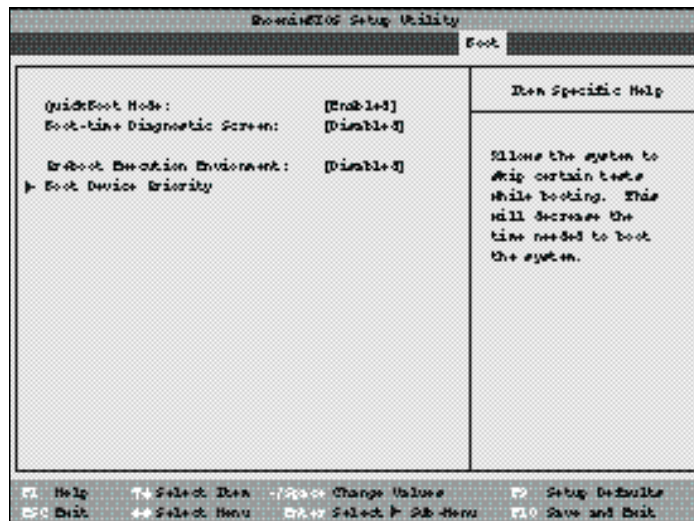


Figure 3-16 Boot Menu

Table 3-16 Fields, Options and Defaults for the Boot Menu

Menu Field	Options	Default	Description
<b>QuickBoot Mode:</b>	<b>Enabled; Disabled.</b>	<b>[Enabled]</b>	<b>Turns on and off booting with a truncated set of Power On Self Test. (Fewer tests mean faster turn on.)</b>
<b>Boot-time Diagnostic Screen:</b>	<b>Enabled; Disabled.</b>	<b>[Disabled]</b>	<b>Turns on and off display of test results instead of Fujitsu logo screen during Power On Self Test.</b>
<b>Preboot Execution Environment:</b>	<b>Enabled; Disabled.</b>	<b>[Disabled]</b>	<b>Turns on and off the preboot execution environment feature.</b>
<b>Boot Device Priority:</b>	<b>Selects the Boot Device Priority submenu.</b>	—	<b>This menu allows setting up the source for the operating system.</b>

**Configuring Your LifeBook 200 Series****The Boot Device Priority Submenu of the Boot Menu**

The Boot Device Priority Submenu is for setting the order of checking of sources for the operating system. Follow the instructions for Navigating Through the Setup Utility to make any changes. (See page 55.)

Table 3-17 shows the names of the menu fields for the Boot Device Priority submenu, all the options for each field, the default settings and a description of the field's function and any special information needed to help understand the field's use.

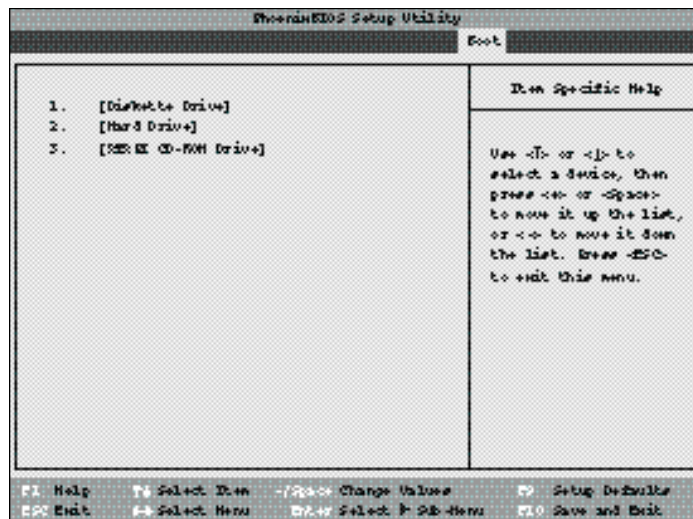


Figure 3-17 Boot Device Priority Submenu

Table 3-17 Fields, Options and Defaults for the Boot Device Priority Submenu

Menu Field	Options	Default	Description
1. Diskette Drive:	---	---	<b>The boot selections determine the order in which the BIOS searches for the operating system during a startup sequence. To change the order highlight one source by using the up ↑, down ↓ cursor keys and then press the + or - key to change the order number for that source. Be sure to save your changed order when you exit the BIOS setup utility.</b>
2. Hard Drive:	---	---	
3. ATAPI CD-ROM Drive:	---	---	

#### Exiting from Boot Menu

When you have finished setting the boot parameters with the Boot menu, you can either exit from the setup utility or move to another menu. If you wish to exit from the setup utility press the Esc key to go to the Exit menu. If you wish to move to another menu, use the cursor keys.

### Configuring Your LifeBook 200 Series

#### INFO MENU – DISPLAYING BASIC SYSTEM INFORMATION

The Info menu is a display only menu that provides the configuration information for your notebook.

Table 3-18 shows the names of the menu fields for the Info menu, all the options for each field, the default settings and a description of the field's function and any special information needed to help understand the field's use.



#### POINT

The asset number is an optional user-entered field. A asset number can be entered through the use of third party software, such as LANdesk Client Manager.

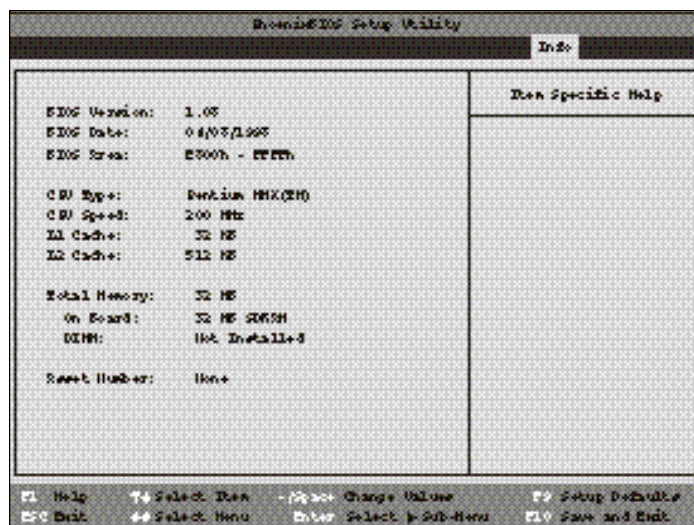


Figure 3-18 Info Menu

Table 3-18 Fields, Options and Defaults for the Info Menu

Menu Field	Options	Default	Description
<b>BIOS Version:</b>	—	<b>1.08</b>	
<b>BIOS Date:</b>	—	<b>04/08/1998</b>	
<b>BIOS Area:</b>	—	<b>E800h – FFFFh</b>	
<b>CPU Type:</b>	—	<b>Pentium MMX™</b>	
<b>CPU Speed:</b>	—	<b>200 MHz</b>	
<b>L1 Cache:</b>	—	<b>32 KB</b>	
<b>L2 Cache:</b>	—	<b>512 KB</b>	
<b>Total Memory:</b>	—	<b>32 MB</b>	
<b>On Board:</b>	—	<b>32 MB SDRAM</b>	
<b>DIMM:</b>	—	<b>Not Installed</b>	
<b>Asset Number:</b>	—	<b>None</b>	

### Configuring Your LifeBook 200 Series

#### EXIT MENU – LEAVING THE SETUP UTILITY

The Exit Menu is used to leave the setup utility. Follow the instructions for Navigating Through the Setup Utility to make any changes. (See page 55.)

Table 3-19 shows the names of the menu fields for the Exit menu, all of the options for each field, the default settings and a description of the field's function and any special information needed to help understand the field's use.

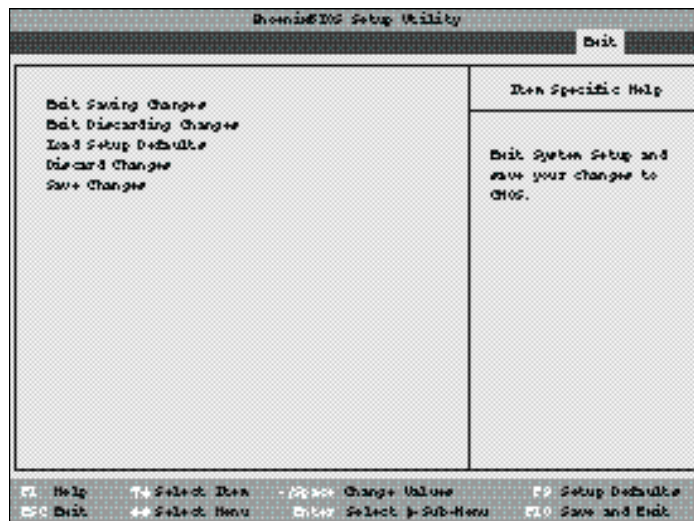


Figure 3-19 Exit Menu

Table 3-19 Fields, Options and Defaults for the Exit Menu.

Menu Field	Options	Default	Description
<b>Exit Saving Changes:</b>	—	—	<b>Selecting Exit Saving Changes will store all the entries on every menu of the setup utility to the BIOS memory and then exit the setup utility. A confirmation message</b> Save Configuration Changes and Exit Now? [Yes] [No] <b>will be displayed.</b>
<b>Exit Discarding Changes:</b>	—	—	<b>Selecting Exit Discarding Changes will exit the setup utility without writing to the BIOS memory. When the BIOS recognizes this selection it will load the operating system and begin operation. A message</b> Warning Configuration Changes have not been saved. Save before exiting? [Yes] [No] <b>will be displayed.</b>
<b>Load Setup Defaults:</b>	—	—	<b>Selecting Load Setup Defaults will load the factory preset default values for all menu fields, then display the message</b> Confirmation Load Default values now? [Yes] [No] <b>When confirmed the setup utility will return to the Exit Menu. To return to another menu follow the directions in the Navigating Through the Setup Utility Section. (See page 57.)</b>

Table 3-19 Fields, Options and Defaults for the Exit Menu.

Menu Field	Options	Default	Description
<b>Discard Charges:</b>	—	—	<b>Load previous values from BIOS for all setup items.</b>
<b>Save Changes:</b>	—	—	<b>Selecting Save Changes will cause the new settings in all menus to be written to the BIOS memory. Setup Confirmation Save Changes now? [Yes] [No] When confirmed the setup utility will return to the Exit menu. To return to another menu, follow the directions in the Navigating Through the Setup Utility section. (See page 57.)</b>

### SETTING UP YOUR SAVE-TO-DISK FILE ALLOCATION

Your notebook comes with an allocation of space on the internal hard drive adequate to operate the Save-to-Disk function for the amount of memory installed at the factory. If you add a memory upgrade module or do not use the Save-to-Disk function and wish to free up the disk space, you will need to change your allocation. The utility to change the allocations is PHDISK.EXE and is activated from the MS-DOS prompt.

PHDISK allows you to perform five different functions related to the Save-to-Disk space on your internal hard drive. They are:

1. Allocate a space for the Save-to-Disk function.
2. Remove all space allocation for the Save-to-Disk function.
3. Find out details about the hard drive and the current Save-to-Disk space allocation.

4. Re-allocate space and mark bad blocks in the space allocated to the Save-to-Disk function when a disk error has occurred.

5. Find out how much space is needed to perform the Save-to-Disk function with the current memory configuration and how much unused space is available on the internal hard drive.

To find out how much space is needed to perform the Save-to-Disk function with the current memory configuration and how much unused space is available on the internal hard drive, do the following:

1. Restart your notebook in MS-DOS mode.
2. At the DOS prompt type  
CD C:\Fujitsu
3. Type PHDISK
4. Press the Enter key.

The screen will display the amount disk space needed to perform the Save-to-Disk function with the current memory configuration and how much unused space is available on the internal hard drive.

To find out details about the hard drive and the current Save-to-Disk space allocation, do the following:

1. Restart your notebook in MS-DOS mode.
2. At the DOS prompt type  
CD C:\Fujitsu
3. Type PHDISK /INFO
4. Press the Enter key.
5. The screen will display the size of the space currently allocated to the Save-to-Disk function and other parameters about the space and the hard drive.

To remove all space allocation for the Save-to-Disk function, do the following:

**1. Go to the Start Menu and select MS-DOS Prompt.**

**2. Type** `CD C:\Fujitsu`

**3. Type** `PHDISK /DELETE /FILE`

**4. Press the Enter key.**

**The utility will remove the space allocation for the Save-to-Disk function and free that space for other use.**

To create a space allocation for the Save-to-Disk function, do the following:

**1. Restart your notebook in MS-DOS mode.**

**1. Type** `CD C:\Fujitsu`

**3. At the DOS prompt type**  
`PHDISK /CREATE /FILE`

**4. Press the Enter key.**

**5. The utility will create a Save-to-Disk file called SAVE2DSK.BIN in the root directory. It will be of the minimum size needed to support the Save-to-Disk function with the current memory configuration.**

If you have had a read or write error when you tried to perform a Save-to-Disk operation you can re-allocate space to compensate for bad blocks on your drive. To do this:

**1. Go to the MS-DOS prompt.**

**2. Type** `CD C:\Fujitsu`

**3. Type** `PHDISK /REFORMAT /FILE`

**4. Press the Enter key.**

**5. The utility will re-create the Save-to-Disk file called SAVE2DSK.BIN with the same usable size and any bad blocks marked.**



#### CAUTION

Never use PARTITION in place of FILE with the PHDISK Utility or you will reformat your internal hard drive and all data, applications and operating system will be destroyed.



**User Installable Features**

Multi-function Bay Devices . . . . .	115
PC Cards . . . . .	121
Parallel Port Devices . . . . .	124
Serial Port Devices . . . . .	124
USB Devices . . . . .	124
Microphone . . . . .	124
Stereo Line In Devices . . . . .	124
Headphones . . . . .	124
Telephone Lines . . . . .	124
Mouse or Keyboard . . . . .	125
External Monitor . . . . .	125
Theft Prevention Lock . . . . .	125
External Installation of a Floppy Disk Drive . . . . .	125
Memory Upgrade Module . . . . .	126
LANdock . . . . .	130
Port Replicator . . . . .	134

## SECTION FOUR

### USER INSTALLABLE FEATURES

Your LifeBook 200 Series has a number of user installable features:

- PC Card slots in the left side panel of your notebook allow you to install PC Cards, IC memory cards (SRAM card) or Zoomed Video cards (Slot 1 only).
- The dual Multi-function bays in the front of your notebook allow you to install the CD-ROM drive, the floppy disk drive, the Zip drive, the Lithium ion battery, an optional second hard drive, or an optional second Lithium ion battery.
- A compartment on the bottom of your notebook allows you to install a memory upgrade module.
- A microphone jack on the right side of your notebook allows you to connect a mono microphone.
- A stereo line in jack on the right side of your notebook allows you to connect a sound source such as a cassette recorder.
- A headphone jack on the right side of your notebook allows you to connect headphones or powered speakers.
- A PS/2 port on the right side of your notebook allows you to connect an external mouse, keyboard or numeric keypad.
- An external floppy disk drive port on the right side of your notebook allows you to attach an external floppy disk drive when the Multi-function bays are being used for other purposes.
- A USB port in the right side of your notebook allows you to connect a Universal Serial Bus device.
- An RJ-11 jack in the back of your notebook allows you to connect a telephone line to the internal modem.
- A docking port on the back of your notebook allows the connection of a docking device.
- A serial port in the back of your notebook allows you to connect serial devices, such as RS-232C serial printers or scanners.
- A parallel port in the back of your notebook allows you to connect a parallel printer, photo or text scanner, etc.
- An external monitor port in the back of your notebook allows you to connect an external monitor.

This section describes how to install and remove equipment for each of the expansion features.

### User Installable Features

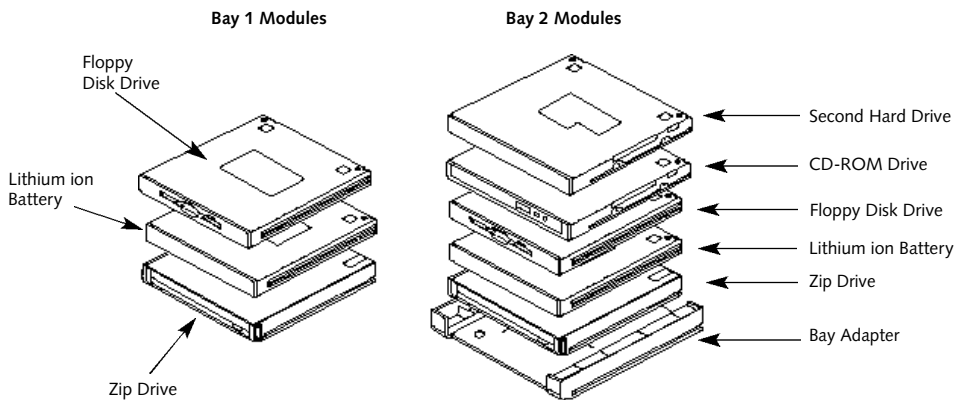


Figure 4-1 Multi-function Bay Modules

#### MULTI-FUNCTION BAY DEVICES

The bays in the front panel of your notebook accommodate the CD-ROM drive, the floppy disk drive, the Zip drive, the Lithium ion batteries (a second battery is optional) or an optional second hard drive.



#### CAUTION

Do not use your notebook with either of the Multi-function Bays empty. It may damage your notebook.



#### CAUTION

All Multi-function Bay devices except the Lithium ion battery must be installed and removed with the power switch in the Off position. The Lithium ion battery may be warm swapped (power on but unit in Suspend mode). (See *Power Off* on pages 24–25 and *Bridge Battery* on page 27.)

**The Multi-function bays support a variety of configurations.**

#### Multi-function Bay 1 supports:

- 3.5" floppy disk drive.  
(Included with your notebook.)
- Lithium ion battery.  
(Included with your notebook.)
- 100MB Zip Drive.  
(Included with your notebook.)

#### Multi-function Bay 2 supports:

- 20-speed maximum CD-ROM drive.  
(Included with your notebook.)

- **100MB Zip drive installed in Bay Adapter for Multi-function Bay 2.**(Adapter included with your notebook.)
- **Optional second hard drive.**
- **3.5" floppy disk drive installed in Bay Adapter for Multi-function Bay 2.** (Adapter included with your notebook.)
- **Lithium ion battery installed in Bay Adapter for Multi-function Bay 2.** (Adapter included with your notebook.)

The Lithium ion battery included with your notebook can power your notebook from either bay. Your notebook also supports a dual battery configuration with a Lithium ion battery in both bays at the same time. (The optional second battery must be purchased separately.) It does not support multiple floppy disk drives, but has three different places to install one.

**POINT**  
 Iomega Zip Disks must be purchased separately.

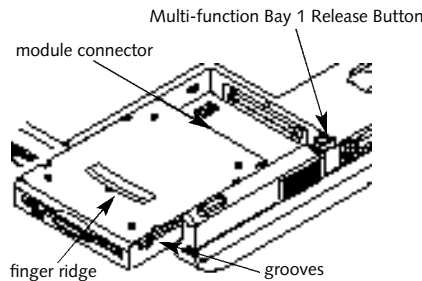


Figure 4-2 Removing and Installing a Device in Multi-function Bay 1

To Install or Remove a Device in Multi-function Bay 1.

1. Close all files and exit all applications.
2. Turn off power to your notebook, close the display and remove the AC adapter. (See *Power Off* on pages 24-25.)
3. Turn your notebook upside down with the bay openings toward you.

To Remove a Device from Multi-function Bay 1

4. Slide the release latch at the right rear corner of Multi-function Bay 1 toward the outer edge of your notebook.
5. Slide the device forward until the unit is clear of the compartment. This will require some force. Use the finger ridge on the bottom of the device.

To Install a Device in Multi-function Bay 1

4. Orient the item to be installed with the finger ridge away from the body of your notebook and the connector toward the body of your notebook.
5. With the module connector toward the back of your notebook align the grooves on the side of the device with the tracks in the side of the bay. (Figure 4-2.)
6. Slide the module toward the back of your notebook until it clicks into place.

**CAUTION**

Be careful aligning and seating modules in the bay. If the fit is incorrect you may damage the bay or the module. If the module does not move easily, remove it, and check for dirt or foreign objects. It will require a firm push to latch the module in place.

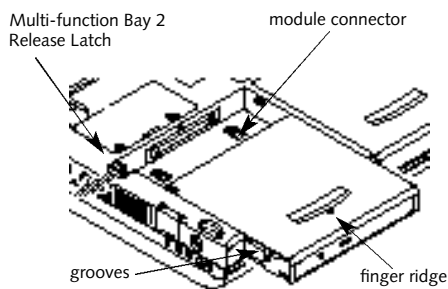


Figure 4-3 Removing and Installing a Device in Multi-function Bay 2

#### To Install or Remove a Device in Multi-function Bay 2.

1. **Close all files and exit all applications.**
  2. **Turn off power to your notebook, close the display and remove the AC adapter.** (See pages 24-25 for more information.)
  3. **Turn your notebook upside down with the bay openings toward you.**
- To Remove a Device from Multi-function Bay 2
4. **Slide the release latch at the left rear corner of Multi-function Bay 2 toward the outer edge of your notebook.**
  5. **Slide the device forward until the unit is clear of the compartment. This will require some force. Use the finger ridge on the bottom of the device.**

#### To Install a Device in Multi-function Bay 2

4. **Orient the item to be installed with the finger ridge away from the body of your notebook**

**and the connector toward the body of your notebook.**

5. **With the module connector toward the back of your notebook align the grooves on the side of the device with the tracks in the side of the bay.** (Figure 4-3.)
6. **Slide the module toward the back of your notebook until it clicks into place.**

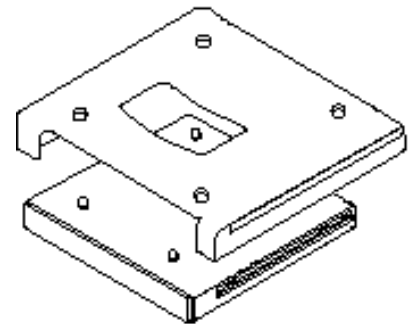


Figure 4-4 Installing a Module in the Bay Adapter for Multi-function Bay 2

To Install a Module in the Bay Adapter for Multi-function Bay 2.

1. **Align the Bay Adapter for Multi-function Bay 2 with the solid side up and the rounded edges toward you.**
2. **Align your Multi-function Bay 1 device with the finger ridge up and the connector away from you.**
3. **Set the Bay Adapter for Multi-function Bay 2 on top of the Multi-function Bay 1 device and adjust until the finger ridge shows through the hole in the Bay Adapter for Multi-function Bay 2, and the alignment pins on the Multi-function Bay 1 device fit in the small round holes of the Bay Adapter for Multi-function Bay 2.**
4. **Hold the two parts together while installing in Multi-function Bay 2 according to the preceding directions.**

To remove a module from the Bay Adapter for Multi-function Bay 2 simply pull them gently apart.



**CAUTION**

The module is not locked into the Bay Adapter for Multi-function Bay 2. Be careful to hold on to both parts or you can easily drop and damage a module or the adapter.

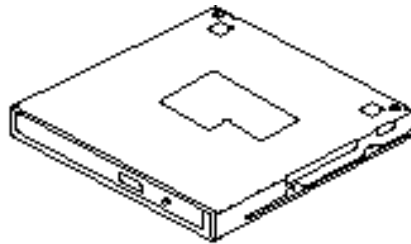


Figure 4-5 CD-ROM Drive

**CD-ROM Drive**

Your CD-ROM drive is durable but you must treat it with care. Please pay attention to the following points:

- **The drive rotates the compact disk at very high speed. Do not carry it around or subject it to shock or vibration with the power on.**
- **Avoid using or storing the drive or CDs where they will be exposed to extreme temperatures.**
- **Avoid using or storing the drive or CDs where it is damp or dusty.**
- **Avoid using or storing the drive near magnets or devices that generate strong magnetic fields.**
- **Avoid storing the drive where it will be subjected to shock or vibration.**
- **Do not disassemble or dismantle the CD-ROM drive.**

For guidance on loading a CD in your CD-ROM drive and caring for CD-ROMs see Section Two. (See pages 36-37.)

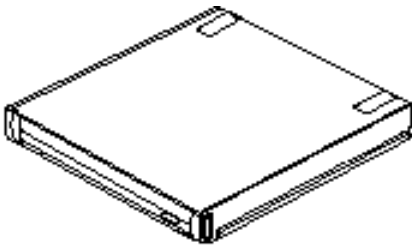
**User Installable Features**

Figure 4-6 Zip Drive

**CAUTION**

The CD-ROM Drive must be installed or removed with the power off.

**Omega Zip Drive**

The Zip drive can be installed in either Multi-function Bay.

Your Zip drive is durable but you must treat it with care. Please pay attention to the following points:

- The drive rotates the Zip disk at a very high

speed. Do not carry it around or subject it to shock or vibration with the power on.

- Avoid using or storing the drive or Zip disks where they will be exposed to temperature extremes.
- Avoid using or storing the drive or Zip disks where it is damp or dusty.
- Avoid using or storing the drive near magnets or devices that generate strong magnetic fields.
- Avoid storing the drive where it will be subjected to shock or vibration.
- Do not disassemble or dismantle the Zip drive.

For guidance on loading a Zip disk in your Zip drive, and caring for Zip disks see Section Two. (See page 38.)

**CAUTION**

The Zip drive must be installed or removed with the power off.

**Optional Second 3.2GB Hard Drive**

The optional second hard drive is durable but you must treat it with care. Please pay attention to the following points:

- The drive rotates the disk at a very high speed. Do not carry it around or subject it to shock or vibration with the power on.
- Avoid using or storing the drive where it will be exposed to extreme temperatures.
- Avoid using or storing the drive where it is damp or dusty.
- Avoid using or storing the drive near magnets or devices that generate strong magnetic fields.
- Avoid storing the drive where it will be subjected to shock or vibration.
- Do not disassemble or dismantle the hard disk drive.

After the optional second hard drive is installed it will take a short time for your notebook to recognize it.

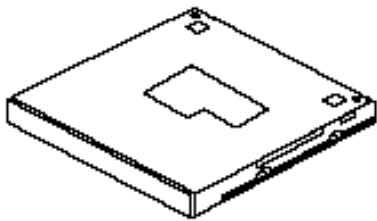


Figure 4-7 Optional Second Hard Drive

**You will need to format your optional second hard drive when you install it for the very first time. Check your operating system documentation for information on initializing a hard drive. Be careful to only format your optional second hard drive once or you will erase everything you have stored on it.**

**CAUTION**

The optional second hard drive must be installed or removed with the power off.

**Lithium ion Battery**

**Your Lithium ion battery is durable and long lasting but should not be exposed to extreme temperatures, high voltages, chemicals or other hazards.**

**CAUTION**

If the Lithium ion battery connector is not fully seated, you may not be able to use your notebook or charge your battery.

**Installing the Battery**

The battery may be installed in either bay, using the Bay Adapter for Multi-function Bay 2. With the purchase of an additional battery, batteries may be installed in a dual configuration, one in each bay. A bridge battery allows a charged Lithium ion battery to be exchanged for a discharged one by “warm-swapping”. To warm-swap, have a charged battery ready to install, put your notebook in Suspend mode, remove the low battery and quickly insert the charged

**battery. The NiCd bridge battery is built-in your notebook and is constantly being charged. The bridge battery capacity is not large, about 3 minutes, and can vary with the condition of your notebook. (See page 27.)**

**CAUTION**

Data may be lost and/or system errors introduced if the warm-swap is not performed quickly or a power adapter is not installed.



Figure 4-8 Lithium ion Battery

**CAUTION**

The bridge battery can not support an active notebook. The notebook must be in Suspend mode.

Batteries should be removed and stored separately in a cool dry place if your notebook is not going to be used for an extended period of time.

Under federal, state or local law it may be illegal to dispose of batteries by putting them in the trash. Please take care of our environment and dispose of batteries properly. Check with your local government authority for details regarding recycling or disposing of your old battery, or contact your support representative at 1-800-8FUJITSU (1-800-838-5487).

**Floppy Disk Drive**

The floppy disk drive can be installed in either Multi-function Bay. In Bay 1 install directly, or in Bay 2 install in the Bay Adapter first. In addition, an optional external floppy disk drive may be

purchased to use when both Multi-function bays are needed for other uses. (For information on the care and use of floppy disk drives see *Floppy Disk Drive* in Section Two on pages 34-36. To install an external floppy disk drive see *External Installation of a Floppy Disk Drive* on page 107.)

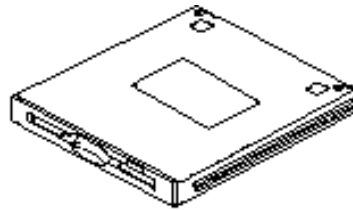


Figure 4-9 Floppy Disk Drive

**CAUTION**

The floppy disk drive must be installed or removed with the power off.

**PC CARDS**

PC Cards perform a wide variety of functions, and are ideal for mobile computers.

Some available PC Cards:

- Fax/data modem cards (Type II).
- Local area network (LAN) cards (Type II).
- Wireless LAN cards (Type II).
- 1MB and 2MB static RAM (SRAM) cards (Type I).
- IDE solid-state disk cards (Type II).
- SCSI cards (Type II).
- Zoomed Video cards (Type II, Slot 1 only).
- ATA cards (Type III).
- Other PC Cards that conform to PCMCIA 2.1 or CardBus standards.

For further information, refer to the instructions supplied with your PC Card.

### POINT

MPEG playback using zoom video in 24 bit (true color) mode is not supported with the DSTN display. For optimal MPEG playback performance using zoom video, use 256 or 16 bit (high color) modes.

#### Caring for PC Cards

PC Cards are durable; however, you must treat them with care. The documentation supplied with your PC Card will provide specific information but you should pay attention to the following points:

- To keep out dust and dirt, store PC Cards in their protective sleeves when they are not installed in your notebook.
- Avoid prolonged exposure to direct sunlight or excessive heat.
- Keep the cards dry.

- Do not flex or bend the cards, and do not place heavy objects on top of them.
- Do not force cards into the slot.
- Avoid dropping cards, or subjecting them to excessive vibration.

#### Installing PC Cards in Your Notebook

PC cards are installed in the PC Card slots in the left side panel of your notebook. Some PC Cards will not work when all possible devices are enabled. If a PC Card is not recognized, you will need to open the Control panel, the System folder, and then the Device Manager, and choose a device to disable so that the resources can be used by the PC Card.

### CAUTION

Do not insert a PC Card into a slot if there is water or any other substance on the card; you may permanently damage the card, your notebook, or both.

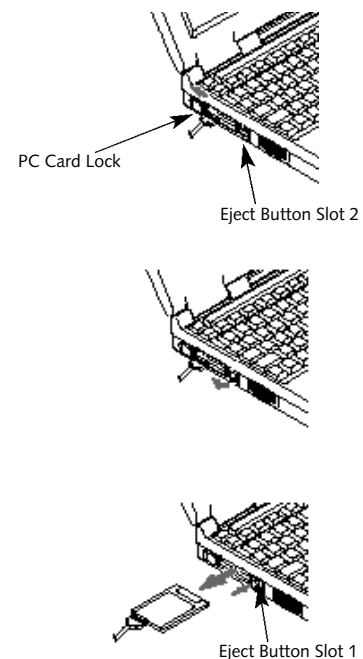


Figure 4-10 Installing and Removing a PC Card

To install a PC Card:

1. See your PC Card manual for instructions on installation of that specific card.
2. Make sure that there is not already a PC Card in the slot. If there is, eject it, as described in Removing PC Cards.



#### CAUTION

Some PC Cards can only be installed or removed with the power in Suspend mode, some only with power Off. Please check the card documentation for correct usage.

3. Insert the PC Card in the card slot, with the product name label facing up. (Figure 4-10.)
4. When the PC Card is fully inserted, the eject button will pop out.
5. Flip this button toward the front of your notebook to fold it out of the way.

6. When the card is installed, lock it in place by sliding the Lock button toward the front of your notebook. (Figure 4-10.)



#### CAUTION

Installing or removing a card while your notebook is in the process of going through the power on or power off sequence may damage the card and/or your notebook.

#### Removing PC Cards

If you wish to remove or replace the PC Card, use the following procedure:

1. Shutdown operation of the card.
2. Click on the PC Card indicator on the Windows taskbar.

From the PC Card Properties Window:

3. Select the card to be removed and click on the Stop button.



#### CAUTION

Windows 95 has a shutdown procedure for PC Cards that must be followed before beginning to remove a card.

4. Verify that the You can safely remove your card message appears.
5. If the device cannot be removed message appears, save all files, close all applications, and exit Windows 95 then shut-off the power with the power switch. (See Power Off on pages 24-25.)



#### CAUTION

If the PC Card has an external connector and cable, do not pull on this cable when removing the card.

#### PARALLEL PORT DEVICES

To connect a parallel interface device to the parallel port, be sure that the connector is the right size and aligned, then push in until it is fully seated. When it is seated tighten the hold-down screws, one on each end of the connector. (See Figure 1-9 on page 8.)

#### SERIAL PORT DEVICES

To connect an RS-232C device to the serial port, be sure that the connector is the right size and aligned, then push in until it is fully seated. When it is seated tighten the hold-down screws, one on each end of the connector. (See Figure 1-9 on page 8.)

#### USB DEVICES

When installing a device on the USB Port, be sure that the connector is the right size, aligned, and fully seated. (See Figure 1-8 on page 7.)



#### CAUTION

Due to ongoing changes in USB technology and standards not all USB devices and/or drivers are guaranteed to work.

#### MICROPHONE

Make sure that your mono microphone is equipped with an 1/8" (3.5 mm) mono mini-plug. Make sure the plug is aligned and push it into the jack until fully seated. (See Figure 1-8 on page 7.)

#### STEREO LINE IN DEVICE

Make sure that your stereo line in audio device, a cassette recorder, for example, is equipped with an 1/8" (3.5 mm) stereo mini-plug. Make sure the plug is aligned and push it into the jack until fully seated. (See Figure 1-8 on page 7.)

#### HEADPHONES

Make sure that your stereo headphones are equipped with an 1/8" (3.5 mm) stereo mini-plug. Make sure the plug is aligned and push it into the jack until fully seated. (See Figure 1-8 on page 7.)



#### POINT

Plugging in headphones disables the built-in stereo speakers.

#### TELEPHONE LINES

To attach a telephone line to the internal modem open the rear panel connector cover or with the cover closed slide the panel in the connector cover slightly opened to reveal the RJ-11 jack. Plug one end of the telephone cable into the telephone line outlet. Orient the telephone cable with the release latch on the connector up. Push it into the jack until it clicks and latches. (See Figure 1-9 on page 8.)



#### CAUTION

The internal modem is not intended for use with Digital PBX systems. Do not connect the internal modem to a digital PBX as it may cause serious damage to the internal modem or your entire notebook. Consult your PBX manufacturer's documentation for details. Some hotels have Digital PBX systems. Be sure to find out BEFORE you connect your modem.

**MOUSE, KEYBOARD OR KEYPAD**

Make sure the connector on your device is the correct PS/2 type. Align the arrow on the connector to point to the bottom of your notebook and push it in until the connector seats. A mouse, keyboard or keypad may be installed and automatically recognized by your notebook without restarting or changing setups. (See Figure 1-8 on page 7.)

**EXTERNAL MONITOR**

You may install an external monitor on the external monitor port on the rear panel of your notebook. Make sure that the wide side of the connector is up and attach it to the port by pushing in until it is seated, then tighten the hold-down screw on each end of the connector. (See Figure 1-9 on page 8.)

**CAUTION**

Pressing **F10** while holding down the **Fn** key allows you to change your selection of where to send your display video. Each time you press the combination of keys you will step to the next choice. The choices, in order, are: built-in display panel only, external monitor only, or both built-in display panel and external monitor.

**THEFT PREVENTION LOCK**

A physical security system lock can be installed on the right side of your notebook. (See Figure 1-8 on page 7 for the location of the lock slot.) Simply insert the key end of your security system in the slot, rotate 90 degrees and lock. (See Figure 1-8 on page 7.)

**EXTERNAL INSTALLATION OF A FLOPPY DISK DRIVE**

To install a floppy disk drive externally, you must purchase an optional external floppy disk drive.

To connect a floppy disk drive externally:

1. Close all files and exit all applications.
2. Turn off power to your notebook, close the display and remove the AC adapter. (See pages 24-25 for more information.)
3. Open the external floppy disk drive port cover on the right side panel of your notebook (see Figure 4-11), by gently pulling on the left side of the cover and then tilting it down.
4. Align the connector of the external floppy disk drive with the connector towards the body of your notebook with the wide side of the connector up. (Figure 4-11.)

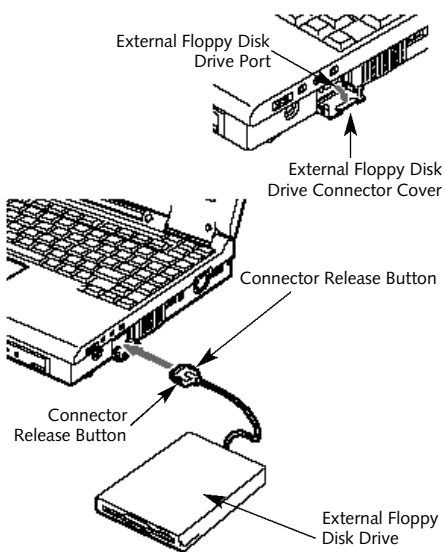


Figure 4-11 External Installation of a Floppy Disk Drive.

5. Insert the connector of the external floppy disk drive firmly into the port on your notebook until it clicks.

To disconnect an external floppy disk drive:

1. Close all files and exit all applications
2. Turn off power to your notebook, close the display and remove the AC adapter. (See pages 24-25 for more information.)
3. Squeeze together firmly on the release buttons on either side of the external floppy disk drive connector next to the body of your notebook. (Figure 4-11.)
4. Pull the connector free.
5. Close the floppy disk drive port cover on your notebook by tilting up and pressing until it latches.

#### MEMORY UPGRADE MODULE

Your notebook has 32MB of installed SDRAM. To increase your memory capacity you may install a memory upgrade module in the memory upgrade compartment in the bottom of your notebook. The memory upgrade module is a dual-in-line memory module (DIMM). You may add modules of different capacity. SDRAM modules are recommended but EDO modules will work. Installing an EDO module will cause your system to operate at a slower rate.



#### CAUTION

Never remove screws except the ones specifically shown in the directions for installing and removing the memory upgrade module.

### User Installable Features

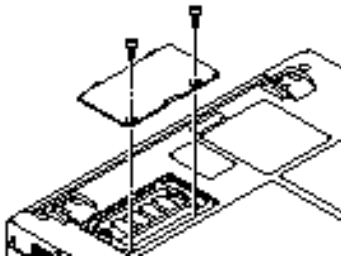


Figure 4-12 Opening the Memory Upgrade Compartment

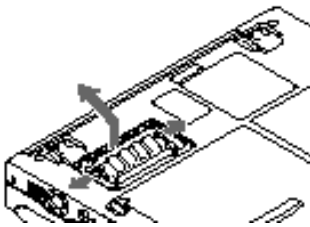


Figure 4-13 Removing a Memory Upgrade Module

#### To Install a Memory Upgrade Module:

1. Turn off power to your notebook using the power switch (see *Power Off* on pages 24-25), and remove any power adapter (AC or auto/airline).
2. Make sure that all the connector covers are closed.
3. Turn the notebook bottom side up, with the front panel toward you.
4. Remove the screws at the front of the memory upgrade module compartment. (See Figure 4-12.)
5. Remove the cover by tilting the front edge up and then pulling forward until the tabs on the cover are free. (See Figure 4-12.)
6. Remove the memory upgrade module from the static guarded sleeve.



#### CAUTION

The memory upgrade module can be severely damaged by electro-static discharge (ESD). Be sure you are properly grounded when handling and installing the module.

7. Align the memory upgrade module with the part side up. Align the connector edge of the memory upgrade module with the connector slot in the compartment. The connector will be pointing toward the rear of the notebook. (Figure 4-13.)
8. Insert the memory upgrade module at a 45° angle. (Figure 4-13.) Press the connector edge of the module firmly down and into the connector.

9. Press the memory upgrade module down into the compartment until it lodges under the retaining clip. You will hear a click when it is properly in place.
10. Replace the cover by hooking the tabs under the rear edge of the compartment opening and tilting down until flush with the bottom of your notebook.
11. Replace the screws.

The memory upgrade module is not something you routinely remove from your notebook. Once it is installed, you can leave it in place unless you want to increase system memory capacity.



#### CAUTION

Before you install or remove the memory upgrade module, save changes and close all files and turn power off to your notebook. (See *Power Off* on pages 24-25.)

#### To Remove a Memory Upgrade Module:

1. Perform steps 1 through 5 of *To Install a Memory Upgrade Module*.
2. Pull the clips sideways away from each side of the memory upgrade module at the same time. (Figure 4-13.)
3. While holding the clips out, remove the module from the slot by lifting it up and pulling towards the front of your notebook. (Figure 4-13.)
4. Store the memory upgrade module in a static guarded sleeve.
5. Replace the cover by following the instructions in steps 10 and 11 of the instructions for *To Install a Memory Upgrade Module*, or install a new memory upgrade module and then replace the cover by following the instructions in steps 7 through 11 of the instructions *To Install a Memory Upgrade Module*.



#### CAUTION

The memory upgrade module can be severely damaged by electro-static discharge (ESD). Be sure you are properly grounded when handling and removing the module.

#### Checking the Computer

##### Recognition of New Memory Capacity

When you have changed system memory capacity by adding or removing a memory upgrade module, be sure to check that your notebook has recognized all of the memory. You can check memory capacity by looking at the Main menu of the setup utility:

1. Turn on power using the power switch.
2. Enter the setup utility by pressing the F2 key as soon as the Fujitsu logo appears on the screen. (See pages 53-54.)

### User Installable Features

**3. The System Memory and the Extended Memory capacity, as detected by your notebook during the Power On Self Test (POST), are displayed at the bottom of the Main menu screen.**

**Example:** A system with 32MB of memory will display 640K System Memory, 31M Extended Memory.

**When you have installed additional memory, the display should change. For example for:**

Total RAM Installed	System Memory	Extended Memory
32 MB	640 K	31M
48 MB	640 K	47M
64 MB	640 K	63M
96 MB	640 K	95M

**If the total memory displayed is not what you believe it should be, check that your memory upgrade module is properly installed. If it is properly installed and the capacity is not correctly recognized, see the Troubleshooting Section starting on page 119.**

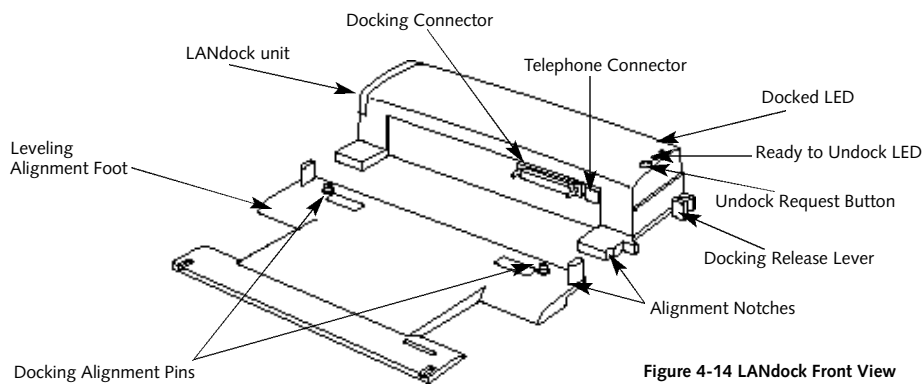


Figure 4-14 LANdock Front View

## LANDOCK

To Install your Notebook in a LANdock

1. **Put your notebook in Suspend mode or turn off the power.**
2. **To use a docking device with your notebook they both must be on a flat surface.**
3. **Remove all connections from the rear panel of your notebook. (See Figure 1-9 on page 8.)**
4. **Make sure that the adjustment feet are flat against the bottom of the notebook and the covers of the connectors, both rear panel and right side panel, are closed.**
5. **Make sure that the slide cover in the rear panel is completely open.**
6. **Set your notebook on the Docking Station Leveler, making sure that the Alignment pins on the leveler (Figures 4-13 and 4-16), fit into the Docking Alignment receptacles in the bottom of your notebook. (See Figure 1-10 on page 9.)**

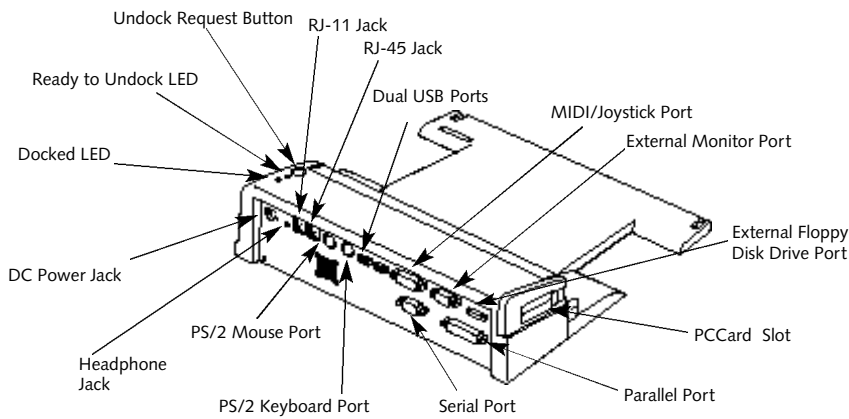
**User Installable Features**

Figure 4-15 LANdock Rear View

**CAUTION**

Follow the instructions that come with your LANdock or Port Replicator. The instructions and illustrations in this manual are only to serve as a guideline. The LANdock manual that is included with the LANdock unit supersedes these instructions.

**POINT**

Audio playback through the headphone jack on the LANdock is very low. For optimal audio playback performance, connect amplified external speakers to the headphone jack and adjust the volume on them.

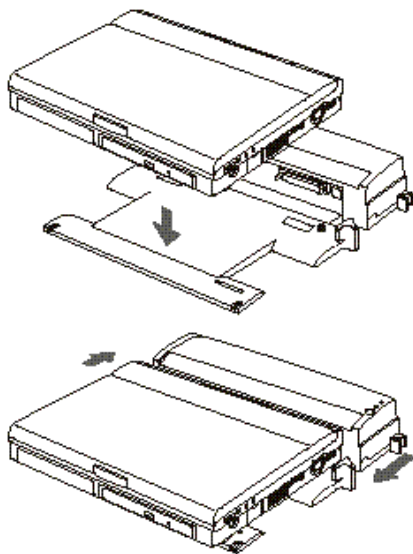


Figure 4-16 Installing a LANdock

7. Arrange the notebook/leveler combination to align the docking connector on the docking device body with the Docking port on your notebook and the notches on the leveler with the notches on the docking device body.
8. Push together firmly.
9. Lock in place by pulling the Docking Release lever forward.
10. Verify that docking is complete by checking that the LifeBook Docked LED is illuminated. (See Figures 4-14 and 4-17.)
11. Return your notebook to operation using the Suspend/Resume button or power switch, as appropriate. (When setting up for the first time you must use the power switch.)

**Connecting Devices to the LANdock or Port Replicator**  
 Connect devices to your LANdock or Port Replicator in exactly the same way you would your notebook. Figure 4-15 shows the location of LANdock ports and jacks. Figure 4-18 shows the location of the Port Replicator ports and jacks. Remember that on the LANdock and the Port Replicator there are separate ports for mouse and keyboard. You must use the correct one.

## User Installable Features

### To Remove Your Notebook from the LANdock

1. From the Start menu, click on Eject PC, or push the Undock Request Button on the LANdock.
2. Wait for the Safe to Undock LED to illuminate, even if a message appears on your screen saying that you may undock.
3. Push the lever on the side of the station backward until the docking device connectors are completely clear of your notebook.
4. Very carefully lift your notebook clear of the Alignment pins in the bottom.



#### POINT

If the notebook power switch is turned off it is always safe to undock. You do not have to turn on your notebook and use the Eject PC feature.



#### CAUTION

The RJ-11 connector on the rear of your docking device comes with a protective cover to keep the connector clean. Be careful to remove it before trying to make a connection. Save the cover and replace it when the connector is not in use.

#### Using Your Notebook

While it is installed in the LANdock there are a few differences you will notice between using your notebook in and out of the LANdock.

In the LANdock you have added capabilities:

- In the Windows 95 Start menu there is a PC Eject choice between the Suspend mode and Shutdown selections. (Use the PC Eject choice or push the "Undock Request Button" on the LANdock to enable the undocking of your LifeBook.)

- Both an external mouse and an external keyboard can be connected at the same time. Be sure to plug them into the correct PS/2 ports.
- There is an additional PC Card slot.



#### CAUTION

When your notebook is mounted in the LANdock it is essentially a desktop PC not a mobile notebook. DO NOT unplug the docking device with the operating system active. You may cause a loss of data and a system error when you restart your notebook.

### PORT REPLICATOR

To connect your notebook to the Port Replicator, follow the docking instructions that come with the Port Replicator.

#### Using Your Notebook

While it is installed in the Port Replicator, there are a few differences you will notice between using your notebook in and out of the Port Replicator.

- Both an external mouse and an external keyboard can be connected at the same time. Be sure to plug them into the correct PS/2 ports.

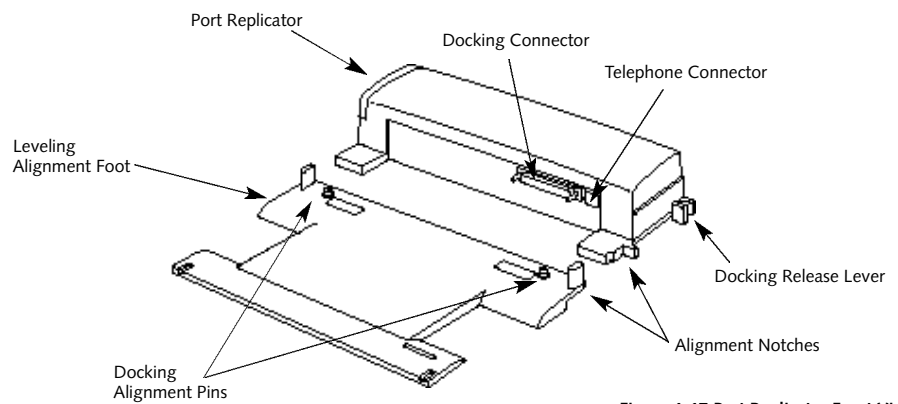
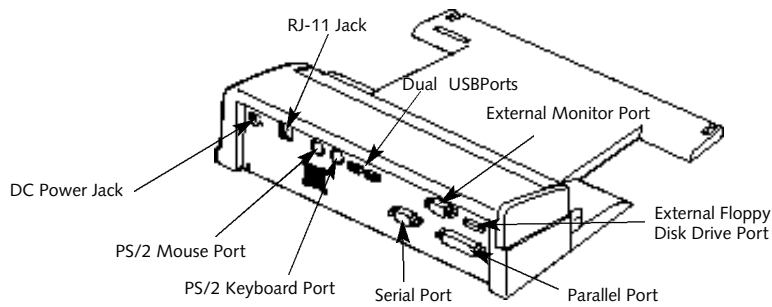


Figure 4-17 Port Replicator Front View

**User Installable Features****Figure 4-18 Port Replicator Rear View****CAUTION**

When your notebook is mounted in the Port Replicator it is essentially a desktop PC not a mobile notebook. **DO NOT** unplug the Port Replicator with the operating system active. You may cause a loss of data and a system error when you restart your notebook.

**Troubleshooting**

Identifying the Problem . . . . .	138
Specific Problems . . . . .	139
Power On Self Test Messages . . . . .	159
Emergency CD-ROM	
Tray Release . . . . .	162
Emergency Zip	
Disk Release . . . . .	162
Modem Setup and Commands . . . . .	162
Restoring Your Pre-installed Software from CD-ROM. . . . .	163

## SECTION FIVE TROUBLESHOOTING

The LifeBook 200 Series from Fujitsu is sturdy and subject to few problems in the field. However, you may encounter simple setup or operating problems that you can solve on the spot, or problems with peripheral devices, that you can solve by replacing the device. The information in this section helps you isolate and resolve some of these straightforward problems, and identify failures that require service.

### IDENTIFYING THE PROBLEM

If you encounter a problem, go through the following procedure before pursuing complex troubleshooting:

1. Turn off your notebook using the power switch on the right side panel.
2. Make sure the AC adapter is plugged into your notebook and to an active AC power source.
3. Make sure that any card installed in the PC Card slot is seated properly. You can also remove the card from the slot, thus eliminating it as a possible cause of failure.
4. Make sure that any devices connected to the external connectors are plugged in properly. You can also disconnect such devices, thus eliminating them as possible causes of failure.
5. Turn on your notebook using the power switch. Make sure it has been off at least 10 seconds before you turn it on.
6. Go through the boot sequence.
7. If the problem has not been resolved, refer to the problem guide table, which follows, for more detailed troubleshooting information. (Page 141 has an index to the table.)



### POINT

If you keep notes about what you have tried, your support representative may be able to help you more quickly by giving additional suggestions over the phone.



### CAUTION

Do not return a failed notebook to your supplier until you have talked to a support representative.

8. If you have tried the solutions suggested in Specific Problems without success, contact your support representative:  
toll free 1-800-8FUJITSU (1-800-838-5487)  
fax 1-901-259-5700  
e-mail [8fujitsu@fpc.fujitsu.com](mailto:8fujitsu@fpc.fujitsu.com)  
Web Site <http://www.8fujitsu.com>.

Before you place the call, you should have the following information ready so that the customer support representative can provide you with the fastest possible solution:

- Product name.
- Product configuration number.
- Product serial number.
- Purchase date.

## T r o u b l e s h o o t i n g

- Conditions under which the problem occurred.
- Any error messages that have occurred.
- Hardware configuration.
- Type of printer connected, if any.

See the Configuration Label on the bottom of your notebook for configuration and serial numbers. (Refer to Figure 1-10 on page 9.)

### SPECIFIC PROBLEMS

#### Using PC-Doctor

PC-Doctor is a diagnostic program by Watergate Software, Inc. which comes pre-installed on your notebook. If you are an experienced computer user you may find it useful, however, it is intended primarily to help your Fujitsu support representative better serve you. When you call for help your support representative may ask you to setup your notebook for modem operation. You will be told

what to do step by step, and then to hang up the phone and plug your phone line into the back of your notebook. Your support representative will then use the service computer to call your notebook and perform diagnostic tests to find the nature of your problem. Messages will be displayed on the screen explaining what is being done and giving any instructions that you need.

#### User Problem Guides

When you have problems with your notebook, try to find the symptoms under the Problem column of the table for the feature giving you difficulty. You will find a description of common causes for that symptom under the column Possible Cause and what, if anything, you can do to correct the condition under Possible Solution.

Remember that it helps to keep notes of what you have tried and the results when you are troubleshooting.

Problem	Page
Audio Problems .....	142
CD-ROM Drive Problems .....	142
Docking Problems .....	144
Floppy Disk Drive Problems .....	144
Hard Drive Problems .....	145
Keyboard or Mouse Problems .....	145
Memory Problems .....	146
Modem Problems .....	147
Parallel, Serial, and USB Device Problems ..	147
PC Card Problems .....	148
Power Failures .....	149
Shutdown and Startup Problems .....	154
Video Problems .....	156
Zip Drive Problems .....	159
Miscellaneous Problems .....	160

Problem

Possible Cause

Possible Solution

Audio Problems

**There is no sound coming from the built-in speakers.**

1. **The volume knob is turned too low.**
2. **The software volume control is set too low.**
3. **Headphones are plugged into your notebook.**
4. **BIOS audio settings are incorrect.**
5. **Software driver is not configured correctly.**

1. **Adjust the volume control knob on the right side of your notebook.**
2. **Adjust the sound volume control settings in your software, both operating system and applications.**
3. **Plugging in headphones disables the built-in speakers, remove the headphones.**
4. **Set the BIOS setup utility, Audio Features submenu of the Advanced menu to the default values. (See pages 73-74.)**
5. **Refer to your application and operating system documentation for help.**

CD-ROM Drive Problems

**Notebook fails to recognize CD-ROM.**

1. **Shipping card is still in the CD-ROM drive tray.**
2. **CD-ROM is installed with label face down.**
3. **CD-ROM is not pushed down onto raised center circle of drive.**
4. **CD-ROM tray is not latched shut.**

1. **Remove shipping card and replace CD in tray.**
2. **Open CD-ROM tray and re-install CD with proper orientation.**
3. **Open CD-ROM tray and re-install CD properly.**
4. **Push on the front of the CD-ROM tray until it latches.**

## T r o u b l e s h o o t i n g

### Problem

The CD-ROM Access indicator on the Status Indicator panel blinks at regular intervals when no CD is in the tray or the CD-ROM drive is not installed.

### Possible Cause

5. Setup utility is set to something other than CD-ROM or Auto for the Secondary Master Controller.
6. Wrong drive designator was used for CD-ROM in the application.
7. Windows CD auto insertion function is disabled.
1. The Windows CD auto insertion function is active and is checking to see if a CD is ready to run.

### Possible Solution

5. **Revise BIOS settings to set the Secondary Master correctly.** (See *Main menu and Primary Master submenu pages 56-62 for more information.*)
6. **Verify the drive designator used by the application is the same as the one used by the operating system. When the operating system is booted from a CD-ROM drive designations are automatically adjusted.** (See *Boot Options submenu on pages 63-64.*)
7. **Start the CD from the desktop or application software or re-enable the Windows CD auto insertion function.** (See *CD-ROM Access Indicator on pages 21-22 for more information.*)
1. **This is normal.**  
You can disable this function if you wish. (See *CD-ROM Access Indicator on pages 21-22 for more information.*)

Problem	Possible Cause	Possible Solution
Docking Problems		
<b>Notebook does not turn on when installed in Docking Station.</b>	<ol style="list-style-type: none"> <li>1. LANdock AC adapter is not plugged in.</li> <li>2. Notebook is not properly seated in the LANdock.</li> </ol>	<ol style="list-style-type: none"> <li>1. Provide power to the LAN-Docking Station.</li> <li>2. Remove and re-dock your notebook and verify that the Docked LED illuminates.</li> </ol>
Floppy Disk Drive Problems		
<b>You cannot access your floppy disk.</b>	<ol style="list-style-type: none"> <li>1. Security is set to protect access to floppy disk data.</li> <li>2. Floppy disk is not loaded correctly.</li> <li>3. BIOS setup utility has Diskette Controller: Disabled</li> <li>4. The floppy disk drive may not be properly installed.</li> <li>5. You tried to write to a write protected floppy disk.</li> </ol>	<ol style="list-style-type: none"> <li>1. Verify your password and security settings.</li> <li>2. Eject floppy disk, check orientation and re-insert. (See <i>Floppy Disk Drive</i> on pages 34-35.)</li> <li>3. Revise the setup utility Main menu settings. (See <i>Main Menu</i> on pages 56-57.)</li> <li>4. Remove and re-install your floppy disk drive. (See <i>Multi-function Bays</i> on pages 97-100, or <i>External Installation of a Floppy Disk Drive</i> on page 107.)</li> <li>5. Eject the floppy disk and set it to write enabled. (See page 35.)</li> </ol>

## T r o u b l e s h o o t i n g

### Problem

#### Hard Drive Problems

**You can not access your hard drive.**

### Possible Cause

1. **The setup utility is set to something other than the characteristics of your internal or optional second hard drive.**
2. **The wrong drive designator was used by an application when a bootable CD-ROM was used to start the notebook.**
3. **Security is set so operating system can not be started without a password.**

### Possible Solution

1. **Revise BIOS settings to set both Primary Master and Primary Slave correctly.** (See *Main Menu and Primary Master Submenu pages 56-62* for more information.) (Internal is Primary Master and optional second is Primary Slave.)
2. **Verify drive designator used by application is in use by the operating system.** When the operating system is booted from a CD-ROM, drive designations are automatically adjusted. (See *Primary Master Submenu on pages 59-62.*)
3. **Verify your password and security settings.** (See *Security menu on pages 77-80.*)

#### Keyboard or Mouse Problems

**The built-in keyboard does not seem to work.**

1. **The notebook has gone into Suspend mode.**
2. **Your application has locked out your keyboard.**

1. **Push the Suspend/Resume button.**
2. **Try to use the ErgoTrac pointing device to access the Start menu and then the ShutDown menu and restart the System.** If this fails then turn your notebook off, wait 10 seconds or more, and then turn it on using the power switch.

**Problem**

**You have installed an external keyboard.**

**Possible Cause**

1. **Your external device is not properly installed.**
2. **Your operating system software is not setup with the correct software driver for that device.**
3. **Your mouse or keyboard is connected to the wrong PS/2 port on the LANdock.**

**Possible Solution**

1. **Re-install your device. (See *Mouse or Keyboard on page 106.*) or mouse, and it does not seem to work.**
2. **Check your device and operating system documentation and activate the proper driver.**
3. **Plug the mouse into the PS/2 Mouse port and the external keyboard or numeric key pad into the PS/2 Keyboard port. (Figure 4-14 on page 111 and Figure 4-17 on page 115.)**

**You have connected an external keyboard or a mouse and it seems to be locking up the system.**

1. **Your operating system software is not setup with the correct software driver for that device.**
2. **Your system has crashed.**

1. **Check your device and operating system documentation and activate the proper driver.**
2. **Restart your system by shutting down and/or turning off the power, waiting at least 10 seconds and then turning the power on again.**

**Memory Problems**

**Your power on screen or Main menu of the BIOS setup utility information does not show the correct amount of installed memory.**

1. **Your memory upgrade module is not properly installed.**

1. **Remove and re-install your memory upgrade module. (See *Memory Upgrade Module on pages 108-110.*)**

## T r o u b l e s h o o t i n g

Problem	Possible Cause	Possible Solution
	<ol style="list-style-type: none"> <li>2. <b>You have a memory failure.</b></li> </ol>	<ol style="list-style-type: none"> <li>2. <b>Make sure display of error messages is enabled</b> (see <i>Boot Options Submenu on pages 56-57</i>), <b>and check for Power On Self Test (POST) messages.</b> (See <i>pages 138-140 for possible messages and their meanings.</i>)</li> </ol>
<p>Modem Problems</p> <p><b>Messages about modem operation.</b></p>	<ol style="list-style-type: none"> <li>1. <b>Messages about modem operation are generated by whichever modem application is in use.</b></li> </ol>	<ol style="list-style-type: none"> <li>1. <b>See your application software documentation for additional information.</b></li> </ol>
<p>Parallel, Serial, and USB Device Problems</p> <p><b>You have installed a parallel-port device, a serial-port device or a USB device. Your notebook does not recognize the device, or the device does not seem to work properly.</b></p>	<ol style="list-style-type: none"> <li>1. <b>The device is not properly installed.</b></li> <li>2. <b>The device may have been installed with an application running and your notebook doesn't know it's there.</b></li> <li>3. <b>Your software may not have the correct software driver active.</b></li> </ol>	<ol style="list-style-type: none"> <li>1. <b>Remove and re-install the device.</b> (See <i>Parallel Port Devices on page 105, Serial Port on Devices on page 105, or USB Devices on page 105.</i>)</li> <li>2. <b>Close your application and restart your notebook.</b></li> <li>3. <b>See your software documentation and activate the correct driver.</b></li> </ol>

Problem

 **CAUTION**

Due to ongoing changes in USB technology and standards, not all USB devices and/or drivers are guaranteed to work.

Possible Cause

4. **You may have the wrong I/O address selected for your device.**
5. **Your device and another device are assigned the same I/O address.**

Possible Solution

4. **See your device documentation and software documentation to determine the required I/O address.**
5. **Check all I/O addresses in the BIOS Setup Utility and your other installed hardware and software and make sure there are no duplications.**

PC Card Problems

**A card inserted in the PC Card slot does not work or is locking up the system.**

1. **The card is not properly installed**
2. **The card may have been installed with an application running and your notebook doesn't know it's there.**
3. **Your software may not have the correct software driver active.**
4. **You may have the wrong I/O address selected for your PC Card device.**
5. **Your PC Card device and another device are assigned the same I/O address.**

1. **Remove and re-install the card.**  
*(See PC Cards on pages 103-105.)*
2. **Close your application and restart your notebook.**
3. **See your software documentation and activate the correct driver.**
4. **See your PC Card documentation to determine the required I/O address.**
5. **Check all I/O addresses in the BIOS setup utility and your other installed hardware and make sure there are no duplications.**

## T r o u b l e s h o o t i n g

Problem	Possible Cause	Possible Solution
<p>Power Failures</p> <p><b>You turn on your notebook and nothing seems to happen.</b></p>	<ol style="list-style-type: none"> <li data-bbox="613 835 1068 940">1. <b>The installed primary battery is completely discharged, there is no optional second battery installed and there is no Power adapter (AC or auto/airline) installed.</b></li>   <li data-bbox="613 1108 1068 1220">2. <b>The primary battery is installed but is completely discharged, there is no optional second battery installed and the Power adapter (AC or auto/airline) is not plugged in properly.</b></li> </ol>	<ol style="list-style-type: none"> <li data-bbox="1094 835 1528 1108">1. <b>When all the batteries are dead there will be a beep when the power switch is turned on and the notebook will immediately go into Dead Battery Suspend mode. (See page 29.) Check the Status Indicator panel to determine the presence and condition of the batteries. (See pages 20-21.) Install the primary battery if it is not installed or a Power adapter if all batteries are dead or unavailable. (See pages 97-100 and 10-11.)</b></li>   <li data-bbox="1094 1108 1528 1356">2. <b>When the batteries are dead there will be a beep when the power switch is turned on and the notebook will immediately go into Dead Battery Suspend mode. (See page 29.) Check the Status Indicator panel to determine the presence and condition of the batteries and adapter. (See Figures 2-3 and 2-4 on pages 20-21.) Verify that your adapter is connected correctly. (See pages 10-11.)</b></li> </ol>

## Problem

## Possible Cause

3. **The primary battery is installed but is completely discharged, there is no optional second battery installed and the Power adapter (AC or auto/airline) has no power from the AC outlet, airplane seat jack, or the car's cigarette lighter.**
4. **The primary battery is installed but is completely discharged, there is no optional second battery installed and the Power adapter (AC or auto/airline) is faulty.**

## Possible Solution

3. **When the battery is dead there will be a beep when the power switch is turned on and the notebook will immediately go into Dead Battery Suspend mode. (See page 29.) Check the Status Indicator cigarette lighter panel to determine the presence and condition of the batteries and adapter. (See Figures 2-3 and 2-4 on pages 20-21.) Move the AC cord to a different outlet, check for a line switch or tripped circuit breaker for the AC outlet, if you are using an auto/airline adapter in a car make sure the ignition switch is in the On or Accessories position.**
4. **When the battery is dead there will be a beep when the power switch is turned on and the notebook will immediately go into Dead Battery Suspend mode. (See page 29.) Verify the cause using the Status Indicator panel to determine the presence and condition of the batteries and adapter. (See Figures 2-3 and 2-4 on pages 20-21.) Try a different Power adapter or install a charged optional second battery.**

## T r o u b l e s h o o t i n g

### Problem

### Possible Cause

5. **Power switch is already in the On position.**
  
6. **There is no battery installed and there is no Power adapter (AC or auto/airline) installed.**
  
7. **The primary battery is installed but is faulty, there is no optional second battery installed and there is no Power adapter (AC or auto/airline) installed.**

### Possible Solution

5. **Try the Suspend/Resume button. If that doesn't work, slide your power switch firmly to the front, pause 10 seconds or more and then firmly to the rear. If you shut down your notebook from Windows 95, you are really in a pseudo-off state, there is some power on and you can restart with the Suspend/Resume button.**  
*(See Power Off on pages 24-25.)*
6. **Use the Status Indicator panel to verify the presence and condition of the batteries.**  
*(See Figure 2-3 on page 20.) Install a Power adapter or install a battery in one of the Multi-function bays in the front of your notebook. (See Multi-function Bay Devices on pages 97-100.) If the battery is not charged use a Power adapter until it is charged.*
7. **Use the Status Indicator panel to verify the presence and condition of the batteries.**  
*(See Figure 2-3 on page 20.) If a battery is indicating a short, remove that battery and operate from another power source or replace that battery.*

Problem	Possible Cause	Possible Solution
<b>Your notebook turns off all by itself.</b>	<p data-bbox="566 793 886 814"><b>8. The battery or batteries are low.</b></p> <p data-bbox="566 1056 1049 1136"><b>1. The power management parameters are set for auto timeouts which are too short for your operating needs.</b></p> <p data-bbox="566 1297 1049 1402"><b>2. You are operating on battery only and have ignored a low battery alarm until the batteries are all at the dead battery state and your machine has gone into Dead Battery Suspend mode.</b></p>	<p data-bbox="1049 793 1484 1035"><b>8. If the batteries are dead there will be a beep when the power switch is turned on and the notebook will immediately go into Dead Battery Suspend mode. (See page 29.) Check the Status Indicator panel to determine the presence and condition of the batteries. (See Figure 2-3 on page 20.) Use a Power adapter to operate until a battery is charged or install a charged battery.</b></p> <p data-bbox="1049 1056 1484 1297"><b>1. Use the keyboard or pointer and if that does not restore operation, push the Suspend/Resume button. Check the PowerPanel settings or close your applications and go to the setup utility Power Savings menu and adjust the timeout values to better suit your operation needs. (See the PowerPanel on pages 40-43 and Power Savings Menu on pages 81-87.)</b></p> <p data-bbox="1049 1297 1484 1377"><b>2. Install a Power adapter and then push the Suspend/Resume button. (See Low Battery State on page 29.)</b></p>

## T r o u b l e s h o o t i n g

Problem	Possible Cause	Possible Solution
Your notebook won't work on battery alone.	<ul style="list-style-type: none"> <li>3. <b>You have a battery failure.</b></li> <li>4. <b>Your Power adapter has failed or lost its power source.</b></li> </ul>	<ul style="list-style-type: none"> <li>3. <b>Verify the condition of the batteries using the Status Indicator panel (Figure 2-3 on page 20), and replace or remove any that are shorted.</b></li> <li>4. <b>Make sure the adapter is plugged in and the outlet has power.</b></li> </ul>
	<ul style="list-style-type: none"> <li>1. <b>The installed batteries are dead.</b></li> <li>2. <b>No batteries are installed.</b></li> <li>3. <b>The batteries are improperly installed.</b></li> <li>4. <b>Your installed batteries are faulty.</b></li> </ul>	<ul style="list-style-type: none"> <li>1. <b>When the batteries are dead there will be a beep when the power switch is turned on and the notebook will immediately go into Dead Battery Suspend mode. (See page 29.) Replace the battery with a charged one or install a Power adapter.</b></li> <li>2. <b>Install a charged battery. (See Multi-function Bay Devices on pages 97-100.)</b></li> <li>3. <b>Verify that the batteries are properly connected by re-installing them. (See Multi-function Bay Devices on pages 97-100.)</b></li> <li>4. <b>Verify the condition of the batteries using the Status Indicator panel (Figure 2-3 on page 20), and replace or remove any that are shorted.</b></li> </ul>

Problem

**The batteries seem to discharge too quickly.**

Possible Cause

1. You are running an application which uses a great deal of power because of frequent hard drive access or CD-ROM access, use of a modem PC Card or of a LAN PC Card.
2. The power savings features may be disabled.
3. The brightness is turned all the way up.
4. The batteries are very old.
5. The batteries have been exposed to high temperatures.
6. The batteries are too hot or too cold. (See Batteries on page 26.)

Possible Solution

1. Use both the primary battery and an optional second battery and/or use a Power adapter for this application when at all possible.
2. Check the PowerPanel and/or setup utility settings in the Power Savings menu (see pages 40-43 and 81-87) and adjust according to your operating needs.
3. Turn down the brightness adjustment. The higher the brightness the more power your display uses.
4. Replace the batteries.
5. Replace the batteries.
6. Restore the notebook to normal operating temperature. (The Charging icon on the Status Indicator panel will flash when the battery is outside its operating range.)

Shutdown and Startup Problems

**The Suspend/Resume button does not work.**

1. The Suspend/Resume button is disabled from the Advanced submenu of the Power menu of the setup utility.

1. Enable the button from the setup utility. (See page 87.)

## T r o u b l e s h o o t i n g

### Problem

**The system powers up, and displays power on information, but fails to load the operating system.**

### Possible Cause

2. **You did not hold the button in long enough.**
3. **There may be a conflict with the application software.**
1. **The boot sequence settings of the setup utility are not compatible with your configuration.**
2. **You have a secured system requiring a password to load your operating system.**
3. **Internal hard drive was not detected.**

### Possible Solution

2. **Hold the button longer. This may need to be a very long time if your application is preventing the CPU from checking for button pushes.**
3. **Close all applications, and try the button again.**
1. **Set the operating source by pressing the Esc key while the Fujitsu logo is on screen or use the F2 key and enter the setup utility and adjust the source settings from the Boot menu on page 89.**
2. **Make sure you have the right password. Enter the setup utility and verify the Security settings and modify them as appropriate. (See Security Menu on pages 77-80.)**
3. **Use the BIOS setup utility Main menu, Primary Master submenu to try to auto detect the internal hard drive.**

**Problem**

**An error message is displayed on the screen during the notebook turn on (boot) sequence.**

**Possible Cause**

**1. Power On Self Test (POST) has detected a problem.**

**Possible Solution**

**1. See the Power On Self Test (POST) Messages (See pages 138-140), to determine the meaning and severity of the problem. Not all messages are errors; some are simply status indicators.**

**Your notebook appears to change setup parameters when you start it.**

**1. BIOS setup changes were not saved when you made them and exited the BIOS setup utility returning it to previous settings.  
2. The BIOS CMOS hold-up battery has failed.**

**1. Make sure you select Save Changes And Exit when exiting the BIOS setup utility.  
2. Contact your support representative for repairs. This is not a user serviceable part but has a normal life of 3 to 5 years.**

**Video Problems**

**The built-in display is blank when you turn on your notebook.**

**1. Something is pushing on the Closed Cover switch. (See Figure 1-7 on page 7.)  
2. The notebook is set for an external monitor only.**

**1. Clear the Closed Cover switch.  
2. Pressing F10 while holding down the Fn key allows you to change your selection of where to send your display video. Each time you press the combination of keys you will step to the next choice. The choices, in order, are built-in display only, external monitor only, both built-in display and external monitor.**

## T r o u b l e s h o o t i n g

### Problem

**The display goes blank by itself after you have been using it.**

### Possible Cause

3. **The angle of the display and the brightness settings are not adequate for your lighting conditions.**
  4. **The power management timeouts may be set for very short intervals and you failed to notice the display come on and go off again.**
  5. **The notebook turned on with a series of beeps.**
- 
1. **The notebook has gone into Video timeout, Standby mode, Suspend mode or Save-to-Disk mode because you have not used it for a period of time.**
  2. **Something is pushing on the Closed Cover switch. (See Figure 1-7 on page 7.)**

### Possible Solution

3. **Move the display and the brightness control until you have adequate visibility.**
  4. **Press any key or move the pointer, if this doesn't work press the Suspend/Resume button. (The display may be shut off by Standby mode, Auto Suspend, or Video Timeout.)**
  5. **Power On Self Test (POST) has detected a failure which does not allow the display to operate. Contact your support representative.**
- 
1. **Use the keyboard or pointer and if that does not restore operation, push the Suspend/Resume button. You may want to change your PowerPanel settings (See pages 40-43), or close your application and go to the setup utility Power Savings menu (See pages 81-87), and adjust the timeout values to better suit your operation needs.**
  2. **Clear the Closed Cover switch.**

Problem	Possible Cause	Possible Solution
	<ol style="list-style-type: none"> <li>3. <b>The power management timeouts may be set for very short intervals and you failed to notice the display come on and go off again.</b></li> </ol>	<ol style="list-style-type: none"> <li>3. <b>Press any key or move the pointer, if this doesn't work press the Suspend/Resume button.</b></li> </ol>
<b>The Built-in Display does not close.</b>	<ol style="list-style-type: none"> <li>1. <b>A foreign object, such as a paper clip, is stuck between the display and the keyboard.</b></li> </ol>	<ol style="list-style-type: none"> <li>1. <b>Remove all foreign objects from the keyboard.</b></li> </ol>
<b>The Built-in Display has bright or dark spots.</b>	<ol style="list-style-type: none"> <li>1. <b>If the spots are very tiny and few in number, this is normal for a large LCD display.</b></li> <li>2. <b>If the spots are numerous or large enough to interfere with your operation needs.</b></li> </ol>	<ol style="list-style-type: none"> <li>1. <b>This is normal; do nothing.</b></li> <li>2. <b>Display is faulty; contact your support representative.</b></li> </ol>
<b>The application display uses only a portion of your screen and is surrounded by a dark band.</b>	<ol style="list-style-type: none"> <li>1. <b>You are running an application that does not support 800 x 600 pixel resolution display and display compression is enabled.</b></li> </ol>	<ol style="list-style-type: none"> <li>1. <b>Display compression gives a clearer but smaller display for applications that do not support 800 x 600 pixel resolution. You can fill the screen but have less resolution by changing your display compression setting. (See Video Features Submenu of the Advanced Menu on pages 75-76.)</b></li> </ol>

## T r o u b l e s h o o t i n g

### Problem

**You have connected an external monitor and it does not come on.**

### Possible Cause

1. **Your BIOS setup is not set to enable your external monitor.**
2. **Your external monitor is not properly installed.**
3. **Your operating system software is not setup with the correct software driver for that device.**
4. **Your external monitor is not compatible with your notebook.**

### Possible Solution

1. **Try toggling the video destination by pressing Fn and F10 together or check your BIOS setup and enable your external monitor.** *(See the Video Features Submenu of the Advanced Menu on pages 75-76.)*
2. **Reinstall your device.** *(See External Monitor on page 106.)*
3. **Check your device and operating system documentation and activate the proper driver.**
4. **See your monitor documentation and the External Monitor Support portions of Appendix A on pages 150-159.**

### Zip Drive Problems

**Notebook fails to recognize Zip drive.**

1. **Security is set to protect access to Zip disk data.**
2. **Zip disk is not properly inserted in drive.**
3. **The Zip disk is not properly formatted.**

1. **Verify your password and security settings.**
2. **Press eject button on Zip drive and reinsert disk.**
3. **Refer to the Iomega Zip Tools software for instructions on formatting Zip disks.**

Problem	Possible Cause	Possible Solution
	<ol style="list-style-type: none"> <li>4. Setup utility is set to something other than ATAPI Removable Drive or Auto for the Secondary Master Controller.</li> <li>5. The Zip drive may not be properly installed.</li> <li>6. You tried to write to a write protected or password protected Zip disk.</li> <li>7. Wrong drive designator was used for Zip drive in the application.</li> </ol>	<ol style="list-style-type: none"> <li>4. Revise BIOS settings to set the Secondary Master correctly. (See Main menu and Primary Master submenu pages 56-62 for more information.)</li> <li>5. Remove and re-install your Zip drive. (See Multi-function Bays on pages 97-100.)</li> <li>6. See disk owner for correct password to access the Zip disk. (See Iomega Tools help.)</li> <li>7. Verify the drive designator used by the application is the same as the one used by the operating system. When the operating system is booted from a Zip drive, designations are automatically adjusted. (See Boot Options submenu on pages 63-64.)</li> </ol>
<p>Miscellaneous Problems</p>		
<p>An error message is displayed on the screen during the operation of an application.</p>	<ol style="list-style-type: none"> <li>1. Application software often has its own set of error message displays.</li> </ol>	<ol style="list-style-type: none"> <li>1. See your application manual and help displays screens for more information. Not all messages are errors; some may simply be status.</li> </ol>

**POWER ON SELF TEST MESSAGES**

The following is an alphabetic list of error-and-status messages that Phoenix BIOS and/or your operating system can generate and an explanation of each message. Error messages are marked with an \*. Comments in italics are suggestions of possible actions for you to consider, or risks resulting from ignoring the message. The most common errors are marked with a #. If an error message is displayed that is not in this list, write it down and check your operating system documentation both on screen and in the manual. If you can find no reference to the message and its meaning is not clear, contact your support representative for assistance.

nnnn Cache SRAM Passed Where nnnn is the amount of system cache in kilobytes successfully tested by the Power On Self Test. (This can only appear if you have an SRAM PC Card installed.)

\*Diskette drive A error or Diskette drive B error Drive A: or B: is present but fails the BIOS Power On Self Test diskette tests. Check to

see that the drive is defined with the proper diskette type in the Utility Setup (see page 57), and that the diskette drive is installed correctly (see pages 97-100 and 107). If the disk drive is properly defined and installed, avoid using it and contact your support representative.

\*Extended RAM Failed at offset:nnnn Extended memory not working or not configured properly. If you have an installed memory upgrade module, verify that the module is properly installed. If it is properly installed, you may want to check your Windows Setup to be sure it is not using unavailable memory until you can contact your support representative.

nnnn Extended RAM Passed Where nnnn is the amount of memory in kilobytes successfully tested.

\*Failing Bits:nnnn The hex number nnnn is a map of the bits at the memory address (in System, Extended, or Shadow memory) which failed the memory test. Each 1 (one) in the map indicates a failed bit. This is a serious fault that

might cause you to lose data if you continue. Contact your support representative.

\*Fixed Disk x Failure or Fixed Disk Controller Failure (where x = 1-4) Fixed disk is not working or not configured properly. This may mean that the hard drive type identified in your Setup Utility does not agree with the type detected by the Power On Self Test. Run the Setup Utility to check for the hard drive type settings and correct them if necessary. If the settings are OK and the message appears when you restart the system, there may be a serious fault which might cause you to lose data if you continue. Contact your support representative.

\*Incorrect Drive A type – run SETUP Type of floppy drive A: not correctly identified in Setup. This means that the floppy disk drive type identified in your Setup Utility does not agree with the type detected by the Power On Self Test. Run the Setup Utility to correct the inconsistency.

\*Incorrect Drive B type – run SETUP **Type of floppy drive B: not correctly identified in Setup.** This means that the floppy disk drive type identified in your Setup Utility does not agree with the type detected by the Power On Self Test. Run the Setup Utility to correct the inconsistency.

\*Invalid NVRAM media type **Problem with NVRAM access.** In the unlikely case that you see this message you may have some display problems. You can continue operating but should contact your support representative for more information.

\*Keyboard controller error **The keyboard controller test failed.** You may have to replace your keyboard or keyboard controller but may be able to use an external keyboard until then. Contact your support representative.

\*Keyboard error **Keyboard not working.** You may have to replace your keyboard or keyboard controller but may be able to use an external keyboard until then. Contact your support representative.

\*Keyboard error nn **BIOS discovered a stuck key and displays the scan code for the stuck key.** You may have to replace your keyboard but may be able to use an external keyboard until then. Contact your support representative.

\*Monitor type does not match CMOS – Run SETUP **Monitor type not correctly identified in Setup.** This error probably means your BIOS is corrupted, run the Setup Utility and set all settings to the default conditions. If you still get this error, contact your support representative.

#\*Operating system not found **Operating system cannot be located on either drive A: or drive C:** Enter the Setup Utility and see if fixed disk and drive A: are properly identified and that the boot sequence is set correctly. Unless you have changed your installation greatly, the operating system should be on drive C: . If the setup utility is correctly set your hard drive is probably corrupted and your system may have to be re-installed from your back up media.

\*Parity Check 1 nnnn **Parity error found in the system bus.** BIOS attempts to locate the address and display it on the screen. If it cannot locate the address, it displays ?????. This is a potentially data destroying failure. Contact your support representative.

\*Parity Check 2 nnnn **Parity error found in the I/O bus.** BIOS attempts to locate the address and display it on the screen. If it cannot locate the address, it displays ?????. This is a potentially data destroying failure. Contact your support representative.

#\*Press <F1> to resume, <F2> to SETUP is displayed after any recoverable error message. Press the F1 key to continue the boot process or the F2 key to enter Setup and change any settings.

#Press <F2> to enter SETUP message is displayed during Power On Self Test. The message can be turned off by the setup utility Boot Options Submenu (see pages 63-64), but the F2 key will still perform the same function.

## T r o u b l e s h o o t i n g

#\*Previous boot incomplete – Default configuration used **Previous Power On Self Test did not complete successfully. Power On Self Test loads default values and offers to run Setup. If the failure was caused by incorrect values and they are not corrected, the next boot will likely fail also. If using the default settings does not allow you to complete a successful boot sequence, you should turn off the power with the Power Switch and contact your support representative.**

\*Real time clock error **Real-time clock fails BIOS test. May require board repair. Contact your support representative.**

\*Shadow RAM Failed at offset:nnnn **Shadow RAM failed at offset nnnn of the 64k block at which the error was detected. You are risking data corruption if you continue. Contact your support representative.**

nnnn Shadow RAM Passed **Where nnnn is the amount of shadow RAM in kilobytes successfully tested.**

\*System battery is dead – Replace and run **SETUP The BIOS CMOS RAM memory hold up battery is dead. This is part of your BIOS and is a board mounted battery which requires a support representative to change. You can continue operating but you will have to use Setup Utility default values or reconfigure your Setup Utility every time you turn off your notebook. This battery has an expected life of 2 to 3 years.**

System BIOS shadowed **System BIOS copied to shadow RAM.**

\*System CMOS checksum bad – run **SETUP BIOS CMOS RAM has been corrupted or modified incorrectly, perhaps by an application program that changes data stored in BIOS memory. Run Setup and reconfigure the system.**

\*System RAM Failed at offset:nnnn **System memory failed at offset nnnn of in the 64k block at which the error was detected. This means that there is a fault in your built-in memory. If you continue to operate you risk corrupting your data. Contact your support representative for repairs.**

nnnn System RAM Passed **Where nnnn is the amount of system memory in kilobytes successfully tested.**

\*System timer error **The timer test failed. The main clock that operates the computer is faulty. Requires repair of system board. Contact your support representative for repairs.**

UMB upper limit segment address:nnnn **Displays the address of the upper limit of Upper Memory Blocks, indicating released segments of the BIOS memory which may be reclaimed by a virtual memory manager.**

Video BIOS shadowed **Video BIOS successfully copied to shadow RAM.**

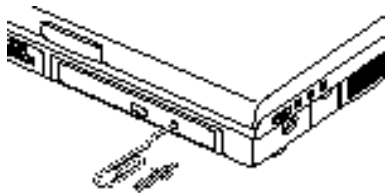


Figure 5-1 Emergency CD-ROM Tray Release

#### EMERGENCY CD-ROM TRAY RELEASE

If for some reason the eject button fails, you can open the CD-ROM tray with a paper clip or similar tool inserted into the eject hole in the far right side of the front of the tray. Straighten one side of a paper clip and push it gently into the hole. The tray will pop out a short distance.

#### EMERGENCY ZIP DISK RELEASE

If for some reason the eject button fails, you can eject a disk from the Zip drive with a paper clip or similar tool inserted into the eject hole in the center of the eject button. Straighten one side of a paper clip and push it gently into the hole. The disk will pop out a short distance.

If the disk does eject easily, remove the paper clip and repeat the process. Under no circumstances should you use excessive force in trying to remove a Zip disk from the drive as this may damage the drive.

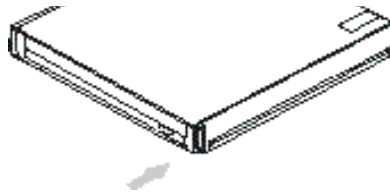


Figure 5-2 Emergency Zip disk Release

#### MODEM SETUP AND COMMANDS

The operating system and application software that is factory installed detects the modem characteristics and provides the necessary command strings to operate the modem. The internal modem operation is controlled by generic AT commands from the operating system and application software. The standard long form result codes may, in some cases, be displayed on

your screen to keep you informed of the actions of your modem. The operating system and application software may suppress display of the result codes.

Examples of result codes are:

OK  
 NO CARRIER  
 NO DIALTONE  
 CONNECT 56000  
 (Connection complete at 56,000 bps.)  
 ERROR  
 FAX  
 RING (This means an incoming call.)  
 BUSY  
 NO ANSWER

When using the internal modem with applications which are not factory installed see the application documentation.

## RESTORING YOUR PRE-INSTALLED SOFTWARE FROM CD-ROM

If you have access to the internet during this process visit our Web Site <http://www.8fujitsu.com> and check the FAQs for hints.



### CAUTION

Remember that you must set the Boot menu in the BIOS setup utility to CD-ROM Drive, or use the **Esc** key during the boot-up sequence to change the setting so the BIOS loads the operating system from the CD-ROM, not the hard drive. (See page 89 for ways to set the operating system source.)



### CAUTION

User data and user installed applications CAN NOT be recovered from the Recovery CD-ROM.

### Recovery Directions

1. Put the Recovery CD-ROM in the CD-ROM drive.
2. Start your notebook.
3. Set the operating system source to be the CD-ROM drive.
4. Follow the instructions on your screen.
5. When recovery is complete, remove the Recovery CD-ROM, replace it in its sleeve and store it.
6. Restart your notebook.
7. Reset your operating system source to be the hard drive, if you wish.



### POINT

As long as there is no boot disk in the CD-ROM drive or the floppy disk drive your notebook will boot from the hard drive, regardless of the operating system source setting.

Your notebook now has all of the software installed that was installed when you received it from the factory. You must now set up the file for your Save-to-Disk function (see *Setting Up Your Save-To-Disk File Allocation* starting on page 93), load any programs which you purchased and installed after you got your notebook, and restore your data files. If you did not choose the format and recover option your data files will still exist. You are now ready to operate.

**Care and Maintenance**

Care and Maintenance . . . . . 166

Caring for Your Notebook. . . . . 166

Increasing Battery Life . . . . . 167

Caring for Your Batteries . . . . . 167

## SECTION SIX

### CARE AND MAINTENANCE

If you use your LifeBook 200 Series from Fujitsu carefully, you will increase its life and reliability. This section provides some tips for looking after the notebook and the battery packs.

### CARING FOR YOUR NOTEBOOK

- The LifeBook 200 Series is a durable but sensitive electronic device. Treat it with respect and care.
- Make a habit of transporting it in a suitable carrying case.
- Keep it away from food and beverages.
- If you accidentally spill liquid on your notebook:
  1. Turn it off.
  2. Position it so that the liquid can run out.
  3. Let it dry out for 24 hours, or longer if needed.
  4. If your notebook will not boot after it has dried out, call your support representative.
- Avoid exposure to water, sand, dust, and other environmental hazards.
- Do not expose your notebook to direct sunlight for long periods of time as temperatures above 140° F (60° C) may damage your notebook.
- Keep the covers closed on the connectors and slots when they are not in use.
- Do not put heavy or sharp objects on the computer.
- If you are carrying your notebook in a briefcase, or any other carrying case, make sure that there are no objects in the case pressing on the lid of your notebook.
- Do not drop your notebook.
- Clean your notebook with a damp, lint-free cloth. Do not use abrasives or solvents.
- Use a soft cloth to remove dust from the screen.

**INCREASING BATTERY LIFE**

To increase battery life:

1. Power your notebook through the AC or optional auto/airline adapter whenever possible.
2. If your notebook is running on battery power all day, connect it to the AC adapter overnight to recharge the battery.
3. Keep brightness to the lowest level comfortable.
4. Set the power management for maximum battery life.
5. Put your notebook in Suspend mode when it is turned on and you are not actually using it.
6. Limit your CD-ROM and Zip drive access.
7. Disable the Windows 95 CD automatic insertion function. (See page 20.)
8. Always use fully charged batteries.

**CARING FOR YOUR BATTERIES**

If your notebook is to be stored for a month or longer, turn the machine off and remove all Lithium ion batteries. Store your notebook and batteries separately in a cool, dry location. If you store your notebook with a battery installed, the battery will discharge, and battery life will be reduced. In addition, a faulty battery might damage your notebook.

**Specifications and Glossary**

**Appendix A Specifications . . . . . 170**  
Warranty . . . . . 170  
LifeBook 270Dx Specifications . . . . . 170  
LifeBook 280Dx Specifications . . . . . 173  
Approvals . . . . . 178  
Popular Accessories . . . . . 178  
**Appendix B Glossary . . . . . 179**

## APPENDIX A SPECIFICATIONS

Appendix A provides the hardware and environmental specifications and the model and part numbers for your LifeBook 200 Series and its peripherals.

### WARRANTY

Your notebook is backed by a limited warranty and includes toll-free technical support; call 1-800-8FUJITSU (1-800-838-5487.) Check the service kit that came with your notebook for warranty terms and conditions.

### LIFEBOOK 270DX SPECIFICATIONS

**Microprocessor**  
Intel Pentium 200MHz with MMX technology, L1 and L2 cache, PCI bus architecture, and CardBus architecture.

### MEMORY

System Memory  
**32MB SDRAM.**

L1 Cache Memory  
**32KB within CPU.**

L2 Cache Memory  
**512KB Pipeline Burst SRAM.**

Expansion Memory  
**16MB, 32MB and 64MB SDRAM Modules extend system memory up to 96MB; installable in a single DIMM (dual in-line memory module) slot in a compartment in the bottom of the notebook. SDRAM Modules are recommended but EDO RAM Modules will work.**

Fujitsu product numbers:  
**16MB SDRAM, FPCEM05.**  
**32MB SDRAM, FPCEM06.**  
**64MB SDRAM, FPCEM07.**

**Installing an EDO RAM Module will cause your entire system to operate at slower EDO timing.**

**8MB EDO RAM, FPCEM01A.**  
**16MB EDO RAM, FPCEM02A.**  
**32MB EDO RAM, FPCEM03.**  
**64MB EDO RAM, Third Party Only.**

BIOS Memory  
**512KB Flash ROM.**  
**256 Bytes CMOS-RAM with back-up battery.**

Video RAM  
**2MB EDO RAM.**

Mass Storage  
Multi-function Device Bays  
**Two.**

Floppy Disk Drive  
**One modular 3.5" floppy disk drive which accommodates a 1.44MB or a 720KB floppy disk, Fujitsu Model FPCFDD03.**  
**One optional external floppy disk drive, Fujitsu Model FPCFD02.**

Hard Drive  
**One factory installed 2.1GB, 2.5" (12.7 mm) fixed hard drive unit.**

**One optional modular 3.2GB, 2.5" (12.7 mm) hard drive unit, Fujitsu Model FPCHDD03.**

CD-ROM Drive  
**One modular, factory installed, 20-speed maximum, 2.5" (12.7 mm) drive, Fujitsu Model FPCCD06.**

**Iomega Zip Drive**

**One modular 100MB, 2.5" (15mm)  
Zip removable media drive unit.**

**Audio**

**SoundBlaster-compatible 16-bit stereo  
PCM/FM sound chip.**

**Spatializer 3D-Stereo multiple speaker  
effect support.**

**Stereo headphone jack, 1 Vrms, or less,  
minimum impedance 32 Ohms.**

**Stereo line in jack, 880 mVrms or less,  
minimum impedance 10K Ohms.**

**Mono microphone jack, 125 mVp-p or less,  
minimum impedance 10K Ohms.**

**Two built-in speakers, 28 mm diameter (Stereo).**

**One built-in monaural microphone.**

**POINT**

Iomega Zip Disks must be purchased separately.

**CAUTION**

Your internal modem is designed to allow faster downloads from K56flex compliant digital sources. Maximum achievable download transmission rates may not reach 56kbps and will vary with line conditions.

**Communication**

**Internal 56K fax/data/voice modem, upgrade-  
able to v. 9.0 (56 Kbps data/voice transmis-  
sion;  
14.4 Kbps fax transmission, DSVD).**

**One IrDA compatible infrared port (4 Mbps).**

**Video**

**MPEG-1 video data decompression software.  
Zoomed Video support via PC Card Slot 1.**

**Bay Adapter for Bay 2**

**Bay adapter for Bay 2,  
Fujitsu Model FPCBYA01.**

**Pre-Installed Software**

**Microsoft Windows 95.**

**Audio Rack 32 for Windows 95**

**by ESS Technology, Inc.**

**LapLink by Traveling Software.**

**MegaPhone by AVEO, Inc.**

**SoftPEG by CompCore Multimedia Inc.**

**McAfee VirusScan by Network Associates.**

**Zip Tools by Iomega.**

**PowerPanel by Phoenix Technologies.**

**Quicken 98 Basic by Intuit.**

**Microsoft Works by Microsoft.**

**Input/Output Connections**

**One Type III/two Type I/II PC Card slots:**

**PCMCIA Standard 2.1 with CardBus  
support; Zoomed Video support via Slot 1.**

**One 6-pin mini DIN PS/2 compatible connec-  
tor, for external keyboard, external mouse or  
external numeric keypad.**

**One 25-pin D-SUB two-way Centronics type  
connector for parallel input/output devices;  
Bi-directional, output only or ECP.**

**One 240-pin connector for docking devices.**

- One 15-pin D-SUB connector for VGA external monitor.** (See *Display specifications.*)
- One 9-pin D-SUB connector for RS-232C serial input/output devices.**
- One connector for USB (Universal Serial Bus) input/output devices.**
- One 25-pin special connector for external floppy disk drive connection.**
- One modular RJ-11 telephone line connector.**
- One stereo headphone jack.**  
(See *Audio specifications.*)
- One mono microphone jack.**  
(See *Audio specifications.*)
- One stereo line in jack.** (See *Audio specifications.*)

**Displays**

- Built-in color flat-panel HPA dual-scan (DSTN) LCD display with simultaneous display capability.**  
  - Diagonal dimension: 12.1"**
  - 800 x 600 pixel resolution, 64K colors.**
  - 640 x 480 pixel resolution, 64K colors.**
  - SVGA, and VGA compatible.**

**External Monitor Support.**

- SVGA, and VGA compatible CRT displays.
- 1280 x 1024 pixel resolution, 256 colors.**
- 1024 x 768 pixel resolution, 64K colors.**
- 800 x 600 pixel resolution, 16M colors.**
- 640 x 480 pixel resolution, 16M colors.**

**Keyboards**

- Built-in keyboard with all functions of 101 key PS/2 compatible keyboards.**
- Total number of keys: 86.**
- Function keys: 12, F1 through F12.**
- Feature extension key: Fn.**
- Windows 95 keys: 3, two Start keys and one Application key.**
- Key pitch: 19 mm.**
- Key stroke: 3 mm.**
- Built-in ErgoTrac pointing device with left and right buttons.**
- Built-in palmrest.**

- External Keyboard Support
- PS/2 compatible.**

- External Numeric Keypad Support
- PS/2 compatible.**

- External Mouse Support
- PS/2 compatible.**

**Power**

**Batteries**

- One modular Lithium ion battery, Fujitsu Model FPCBP11. Rechargeable, 10.8V, 3300mAh.**
- Operating time of up to three (3) hours. Rapid charge (notebook off or in suspend mode) in about three (3) hours. Standard charge (normal use with limited CD and hard drive access) in about nine (9) hours.**



**CAUTION**

Actual battery life will vary based on screen brightness, applications, features, power management settings, battery conditioning, and other customer preferences. CD-ROM or hard drive usage may also have a significant impact on battery life.

## Appendices

### Dual Battery Configuration

**Operating time of up to six (6) hours. Rapid charge (notebook off or in Suspend Mode) in about five (5) hours. Standard charge (normal use with limited CD and hard drive access) in about fifteen (15) hours.**

### AC Adapter

**Autosensing 100-240V AC, 43W, supplying 16V DC to the Notebook, Fujitsu Model FPCAC05 which includes an AC cable.**

### Optional Auto/Airline Adapter

**Autosensing 12/24V DC, 43W supplying 16V DC to the Notebook, Fujitsu Model FPCCAA02.**

### Power Management

**Save-to-Disk, Suspend, Idle and Standby power savings modes. When the battery is fully charged the computer can remain in Suspend mode for approximately 24 hours or more.**

### Dimensions and Weight

#### Overall Dimensions

**Approximately 11.7" x 9.7" x 2.3"  
(297 mm x 246 mm x 58 mm.)**

#### Weight

**Approximately 7.6 lbs (3.5 Kg) with floppy disk drive and battery installed.**

### Environmental Requirements

#### Temperature

**Operating: 5° to 35° C (41° to 95° F).  
Non-operating: -15° to 60° C (5° to 140° F).**

#### Humidity

**Operating: 20% to 85%, relative, non-condensing.  
Non-operating: 8% to 85%, relative, non-condensing.**

#### Altitude

**Operating: 10,000 feet (3,048 m) maximum.**

#### Electro-Static Discharge (ESD)

**9 kV.**

### Theft Prevention Lock

**Lock slot on the right side panel for use with physical restraining security systems. The locking system by Kensington is recommended.**

### LIFEBOOK 280DX SPECIFICATIONS

#### Microprocessor

**Intel Pentium 233MHz processor with MMX technology, L1 and L2 cache, PCI bus architecture, and CardBus architecture.**

#### Memory

**System Memory  
32MB SDRAM.**

#### L1 Cache Memory

**32KB within CPU.**

#### L2 Cache Memory

**512KB Pipeline Burst SRAM.**

#### Expansion Memory

**16MB, 32MB and 64MB SDRAM Modules extend system memory up to 96MB; installable in a single DIMM (dual in-line memory module) slot in a compartment in the bottom of the**

**notebook.SDRAM Modules are recommended but EDO RAM Modules will work.**

Fujitsu product numbers:  
**16MB SDRAM,FPCEM05.**  
**32MB SDRAM,FPCEM06.**  
**64MB SDRAM,FPCEM07.**

**Installing an EDO RAM Module will cause your entire system to operate at slower EDO timing.**

**8MB EDO RAM,FPCEM01A.**  
**16MB EDO RAM,FPCEM02A.**  
**32MB EDO RAM,FPCEM03.**  
**64MB EDO RAM, Third Party Only.**

BIOS Memory

**512KB Flash ROM.**

**256 Bytes CMOS-RAM with back-up battery.**

Video RAM

**2MB EDO RAM.**

Mass Storage

Multi-function Device Bays

**Two.**

Floppy Disk Drive

**One modular 3.5" floppy disk drive which accommodates a 1.44MB or a 720KB floppy disk, Fujitsu Model FPCFDD03.**

**One optional external floppy disk drive, Fujitsu Model FPCFD02.**

Hard Drive

**One factory installed 3.2GB, 2.5" (12.7 mm) fixed hard drive unit.**

**One optional modular 3.2GB, 2.5" (12.7 mm) hard drive unit, Fujitsu Model FPCHDD03.**

CD-ROM Drive

**One modular, factory installed,20-speed maximum,2.5" (12.7 mm) drive, Fujitsu Model FPCCD06. Simultaneous with floppy disk drive.**



**POINT**

Iomega Zip Disks must be purchased separately.

Iomega Zip Drive

**One modular 100MB, 2.5" (15mm) Zip removable media drive unit.**

Audio

**SoundBlaster-compatible 16-bit stereo PCM/FM sound chip.**

**Spatializer 3D-Stereo multiple speaker effect support.**

**Stereo headphone jack, 1 Vrms, or less, minimum impedance 32 Ohms.**

**Stereo line in jack, 880 mVrms or less, minimum impedance 10K Ohms.**

**Mono microphone jack,125 mVp-p or less, minimum impedance 10K Ohms.**

**Two built-in speakers,28 mm diameter (Stereo).**

**One built-in monaural microphone.**

Communication

**Internal 56K fax/data/voice modem, upgradeable to v.90 (56 Kbps data/voice transmission;14.4 Kbps fax transmission, DSVD).**

**One IrDA compatible infrared port (4 Mbps).**

**CAUTION**

Your internal modem is designed to allow faster downloads from K56flex compliant digital sources. Maximum achievable download transmission rates may not reach 56kbps and will vary with line conditions.

**Video**

**MPEG-1 video data decompression software.**  
**Zoomed Video support via PC Card Slot 1.**

**Bay Adapter for Bay 2**  
**Bay adapter for Bay 2,**  
**Fujitsu Model FPCBYA01.**

**Pre-Installed Software**

**Microsoft Windows 95.**

**Audio Rack 32 for Windows 95**  
**by ESS Technology, Inc.**

**LapLink by Traveling Software.**

**MegaPhone by AVEO, Inc.**

**SoftPEG by CompCore Multimedia Inc.**

**McAfee VirusScan by Network Associates.**

**Zip Tools by Iomega.**

**Quicken 98 Basic by Intuit.**

**Microsoft Works by Microsoft.**

**Input/Output Connections**

**One Type III/two Type I/II PC Card slot:**

**PCMCIA Standard 2.1 with CardBus support; Zoomed Video support via Slot 1.**

**One 6-pin mini DIN PS/2 compatible connector, for external keyboard, external mouse or external numeric keypad.**

**One 25-pin D-SUB two-way Centronics type connector for parallel input/output devices; Bi-directional, output only or ECP.**

**One 240-pin connector for docking devices.**

**One 15-pin D-SUB connector for VGA external monitor. (See Display specifications.)**

**One 9-pin D-SUB connector for RS-232C serial input/output devices.**

**One connector for USB (Universal Serial Bus) input/output devices.**

**One 25-pin special connector for external floppy disk drive connection.**

**One modular RJ-11 telephone line connector.**

**One stereo headphone jack.**

*(See Audio specifications.)*

**One mono microphone jack.**

*(See Audio specifications.)*

**One stereo line in jack.**

*(See Audio specifications.)*

**Displays**

**Built-in color flat-panel HPA dual-scan (DSTN) LCD display with simultaneous display capability.**

**Diagonal dimension: 12.1"**

**800 x 600 pixel resolution, 64K colors.**

**640 x 480 pixel resolution, 64K colors.**

**SVGA, and VGA compatible.**

**External Monitor Support.**

**SVGA, and VGA compatible CRT displays.**

**1280 x 1024 pixel resolution, 256 colors.**

**1024 x 768 pixel resolution, 64K colors.**

**800 x 600 pixel resolution, 16M colors.**

**640 x 480 pixel resolution, 16M colors.**

## Keyboards

**Built-in keyboard with all functions of 101 key PS/2 compatible keyboards.**

**Total number of keys: 86.**

**Function keys: 12, F1 through F12.**

**Feature extension key: Fn.**

**Windows 95 keys: 3, two Start keys and one Application key.**

**Key pitch: 19 mm.**

**Key stroke: 3 mm.**

**Built-in ErgoTrac pointing device with left and right buttons.**

**Built-in palmrest.**

**External Keyboard Support**

**PS/2 compatible.**

**External Numeric Keypad Support**

**PS/2 compatible.**

**External Mouse Support**

**PS/2 compatible.**

## Power

### Batteries

**One modular Lithium ion battery, Fujitsu Model FPCBP11. Rechargeable, 10.8V, 3300 mAh. Operating time of up to three (3) hours. Rapid charge (notebook off or in suspend mode) in about three (3) hours. Standard charge (normal use with limited CD and hard drive access) in about nine (9) hours.**



### CAUTION

Actual battery life will vary based on screen brightness, applications, features, power management settings, battery conditioning, and other customer preferences. CD-ROM or hard drive usage may also have a significant impact on battery life.

### Dual Battery Configuration

**Operating time of up to six (6) hours. Rapid charge (notebook off or in Suspend Mode) in about five (5) hours. Standard charge (normal use with limited CD and hard drive access) in about fifteen (15) hours.**

### AC Adapter

**Autosensing 100-240V AC, 43W, supplying 16V DC to the Notebook, Fujitsu Model FPCAC05 which includes an AC cable.**

### Optional Auto/Airline Adapter

**Autosensing 12/24V DC, 43W supplying 16V DC to the Notebook, Fujitsu Model FPCCAA02.**

### Power Management

**Save-to-Disk, Suspend, Idle and Standby power savings modes. When the battery is fully charged the computer can remain in Suspend mode for approximately 24 hours or more.**

**Dimensions and Weight**

## Overall Dimensions

**Approximately 11.7" x 9.7" x 2.3"**  
**(297 mm x 246 mm x 58 mm.)**

## Weight

**Approximately 7.6 lbs (3.5 Kg) with floppy disk drive and battery installed.**

**Environmental Requirements**

## Temperature

**Operating: 5° to 35° C (41° to 95° F).**

**Non-operating: -15° to 60° C (5° to 140° F).**

## Humidity

**Operating: 20% to 85%, relative, non-condensing.**

**Non-operating: 8% to 85%, relative, non-condensing.**

## Altitude

**Operating: 10,000 feet (3,048 m) maximum.**

## Electro-Static Discharge (ESD)

**9 kV.**

**Theft Prevention Lock**

**Lock slot on the right side panel for use with physical restraining security systems. The locking system by Kensington is recommended.**

## APPROVALS

### Emissions

FCC Part 15, FCC Part 68, FTZ.

### Safety

UL, C-UL, CSA.

### FCC Certification

See statement at the front of this User's Guide.

### DOC (Industry Canada) Certification

See statement at the front of this User's Guide.

## POPULAR ACCESSORIES

Other accessories are available, contact your authorized Fujitsu reseller.

Optional second modular Lithium ion battery, Fujitsu Model FPCBP11.

Optional modular 3.2GB hard drive, Fujitsu Model FPCHDD03.

**LANdock, Fujitsu Model FPCDS11. The LANdock provides connections for:**

RS-232C Serial device.

Parallel device.

VGA/SVGA/XGA monitor.

Mouse (PS/2).

Keyboard (PS/2).

Slot for Two Type II/one Type III PC Cards without Zoomed Video support.

Telephone line (RJ-11).

10/100 Base-T Ethernet line (RJ-45).

MIDI/joystick device.

Two USB devices.

External floppy disk drive.

Stereo Headphone.

Microphone.

Stereo Line In.

**Port Replicator, Fujitsu Model FPCPR07. The Port Replicator provides connections for:**

RS-232C Serial device.

Parallel device.

VGA/SVGA/XGA monitor.

Mouse (PS/2).

Keyboard (PS/2).

Telephone line (RJ-11).

Two USB devices.

External floppy disk drive.

Microphone.

Stereo Line In.

## APPENDIX B GLOSSARY

**AC Adapter**

A device which converts the AC voltage from a wall outlet to the DC voltage needed to power your computer.

**ACPI 1.0**

Advanced Configuration and Power Interface specification version 1.0. Conforming systems contain BIOS support to allow next generation Windows operating systems to manage power consumption of system components. (Feature available in Windows 98.)

**Active-Matrix Display**

A type of technology for making flat-panel displays which has a transistor or similar device for every pixel on the screen.

**Auto/Airline Adapter**

A device which converts the DC voltage from an automobile cigarette lighter or aircraft DC power outlet to the DC voltage needed to power your notebook.

**BIOS**

Basic Input-Output System. A computer program and set of default parameters stored in ROM which tests and operates your computer when you turn it on until it loads your installed operating system from disk. Information from the BIOS is transferred to the installed operating system to provide it with information on the configuration and status of the hardware.

**Bit**

An abbreviation for binary digit. A single piece of information which is either a one (1) or a zero (0).

**bps**

An abbreviation for bits per second. Used to describe data transfer rates.

**Boot**

To start-up a computer and load its operating system from disk, ROM or other storage media into RAM.

**Bus**

An electrical circuit which passes data between the CPU and the sub-assemblies inside your computer.

**Byte**

8 bits of parallel binary information.

**Cache Memory**

A block of memory built into the micro-processor which is much faster to access than your system RAM and used in specially structured ways to make your overall data handling time faster.

**CardBus**

A faster, 32-bit version of the PC Card interface which offers performance similar to the 32-bit PCI architecture.

**CD-ROM**

Compact disc read-only memory. This is a form of digital data storage which is read optically with a laser rather than a magnetic head. A typical CD-ROM can contain about 600MB of data and is not subject to heads crashing into the surface and destroying the data when there is a failure nor to wear from reading.

**CHS Translation**

**Cylinder, head and sector translation.**

Conversion of hard drive access addressing to the cylinder, head and sector form. The terminology is historical, left from the days when data was stored on a series of cylindrical drums. The head designates the reading device, similar to the head on a cassette recorder only mounted on a movable arm. Another addressing method is LBA.

**CMOS RAM**

Complementary metal oxide semiconductor random access memory. This is a technology for manufacturing random access memory which requires very low levels of power to operate.

**COM Port**

Abbreviation for communication port. This is your serial interface connection.

**Command**

An instruction which you give your operating system. Example: run a particular application or format a floppy disk.

**Configuration**

The combination of hardware and software that makes up your system and how it is allocated for use.

**CRT**

Cathode Ray Tube. A display device which uses a beam of electronic particles striking a luminescent screen. It produces a visual image by varying the position and intensity of the beam.

**Data**

The information a system stores and processes.

**DC**

Direct current. A voltage or current that does not fluctuate periodically with time.

**Default Value**

A preprogrammed value to be used if you fail to set your own.

**DIMM**

Dual In-line Memory Module.

**Disk**

A spinning platter of magnetic data storage media. If the platter is very stiff it is a hard drive, if it is highly flexible it is a floppy disk, if it is a floppy disk in a hard housing with a shutter it is commonly called a diskette.

**Disk Drive**

The hardware which spins the disk and has the heads and control circuitry for reading and writing the data on the disk.

**Diskette**

A floppy disk in a hard housing with a shutter.

**DMA**

Direct Memory Access. Special circuitry for memory to memory transfers of data which do not require CPU action.

**DMI**

Desktop Management Interface. A standard that provides PC management applications with a common method of locally or remotely querying and configuring PC computer systems, hardware and software components, and peripherals.

## Appendices

**DOS**

**Disk Operating System (MS-DOS is a Microsoft Disk Operating System).**

**Driver**

A computer program which converts application and operating system commands to external devices into the exact form required by a specific brand and model of device in order to produce the desired results from that particular equipment.

**ECP**

**Extended Capability Port.**A set of standards for high speed data communication and interconnection between electronic devices.

**ESD**

**Electro-Static Discharge.** The sudden discharge of electricity from a static charge which has built-up slowly. Example: the shock you get from a doorknob on a dry day or the sparks you get from brushing hair on a dry day.

**Extended Memory**

All memory more than the 640KB recognized by MS-DOS as system memory.

**FCC**

Federal Communication Commission.

**Floppy Disk**

A spinning platter of magnetic data storage media which is highly flexible.

**GB**

Gigabyte.

**Gigabyte**

1,073,741,824 bytes  
(2 raised to the thirtieth power).

**Hard drive**

A spinning platter of magnetic data storage media where the platter is very stiff.

**Hexadecimal**

A decimal notation for the value of a 4 bit binary number. (0-9,A, B, C, D, E,F) Example:  
2F in hexadecimal = 00101111 in binary =  
47 in decimal.

**I/O**

**Input/Output.**Data entering and leaving your computer in electronic form.

**I/O Port**

The connector and associated control circuits for data entering and leaving your computer in electronic form.

**IDE**

**Intelligent Drive Electronics.**A type of control interface for a hard drive which is inside the hard drive unit.

**Impedance**

The amount of resistance to the flow of electric current.

**Infrared**

Light just beyond the red portion of the visible light spectrum which is invisible to humans.

**IR**

An abbreviation for infrared.

**IrDA**

**Infrared Data Association.** An organization which produces standards for communication using infrared as the carrier.

**IRQ**

**Interrupt Request.** An acronym for the hardware signal to the CPU that an external event has occurred which needs to be processed.

**KB**

**Kilobyte.**

**Kilobyte**

**1,024 bytes (2 raised to the tenth power).**

**LAN**

**Local Area Network.** An interconnection of computers and peripherals within a single limited geographic location which can pass programs and data amongst themselves.

**LBA**

**Logical Block Addressing.** A method of locating data stored on a disk.

**LCD**

**Liquid Crystal Display.** A type of display which makes images by controlling the orientation of crystals in a crystalline liquid.

**Lithium ion Battery**

**A type of rechargeable battery which has a high power-time life for its size and is not subject to the memory effect as Nickel Cadmium batteries.**

**LPT Port**

**Line Printer Port.** A way of referring to parallel interface ports because historically line printers were the first and latter the most common device connected to parallel ports.

**MB**

**Megabyte.**

**Megabyte**

**1,048,576 bytes  
(2 raised to the twentieth power).**

**Megahertz**

**1,000,000 cycles per second.**

**Memory**

**A repository for data and applications which is readily accessible to your computer CPU.**

**MHz**

**Megahertz.**

**MIDI**

**Musical Instrument Digital Interface.** A standard communication protocol for exchange of information between computers and sound producers such as synthesizers.

**Modem**

**A contraction for MODulator-DEModulator. The equipment which connects a computer or other data terminal to a communication line.**

**MMX Technology**

**MMX technology is an Intel processor enhancement that improves multimedia and communication applications. The Pentium processor with MMX technology boasts three primary architectural design enhancements: 57 powerful new instructions specifically designed to manipulate and process video, audio and graphical data efficiently; Single Instruction Multiple Data**

## Appendices

**(SIMD)** enabling one instruction to perform the same function on multiple pieces of data; and more L1 cache for a total of 32KB.

### **Monaural**

A system using one channel to process sound from all sources.

### **MPU-401**

A standard for MIDI interfaces and connectors.

### **NTSC**

National TV Standards Commission. The standard for TV broadcast and reception for the USA.

### **Operating System**

A group of control programs that convert application commands, including driver programs, into the exact form required by a specific brand and model of microprocessor in order to produce the desired results from that particular equipment.

### **PAL**

Phase Alternation by Line. The standard for color television in Western Europe and most of Asia and Africa.

### **Parallel Port**

A connection to another device through which data is transferred as a block of bits simultaneously with a wire for each bit in the block and with other wires only for control of the device not for transfer of data.

### **Partition**

A block of space on a hard drive which is set aside and made to appear to the operating system as if it were a separate disk, and addressed by the operating system accordingly.

### **PCMCIA**

A trademark of the Personal Computer Memory Card International Association. The Personal Computer Memory Card International Association is an organization that sets standards for add-in cards for personal computers.

### **Peripheral Device**

A piece of equipment which performs a specific function associated with but not integral to a computer. Examples: a printer, a modem, a CD-ROM.

### **PIO**

Parallel Input/Output.

### **Pitch (keyboard)**

The distance between the centers of the letter keys of a keyboard.

### **Pixel**

The smallest element of a display, a dot of color on your display screen. The more pixels per area the clearer your image will appear.

### **POST**

Power On Self Test. A program which is part of the BIOS which checks the configuration and operating condition of your hardware whenever power is applied to your Computer. Status and error messages may be displayed before the operating system is loaded. If the self test detects failures that are so serious that operation can not continue, the operating system will not be loaded.

**Program**

An integrated set of coded commands to your computers telling your hardware what to do and how and when to do it.

**PS/2**

An IBM series of personal computers which established a number of standards for connecting external devices such as keyboards and monitors.

**RAM**

Random Access Memory. A hardware component of your computer that holds binary information (both program and data) as long as it has the proper power applied to it.

**RAM Module**

A printed circuit card with memory and associated circuitry which allows the user to add additional memory to the computer without special tools.

**Reset**

The act of reloading the operating system. A reset erases all information stored in RAM.

**Restart**

See Reset.

**Resume**

To proceed after interruption. In your Computer this refers to returning to active operation after having been in one of the suspension states.

**ROM**

Read Only Memory. A form of memory in which information is stored by physically altering the material. Data stored in this way can not be changed by your Computer and does not require power to maintain it.

**SCSI**

Small Computer Systems Interface (pronounced scuzzy). An American National Standards Institute (ANSI) standard for connecting multiple (up to 7) high speed parallel devices to a computer.

**SDRAM**

Synchronous Dynamic Random Access Memory.

**Serial Port**

A connection to another device through which data is transferred one bit at a time on a single wire with any other wires only for control of the device not for transfer of data.

**Shadow RAM**

A technique of copying data or applications stored in ROM (Read Only Memory) into RAM (Random Access Memory) for access during actual operation. RAM is much faster to access than ROM, however ROM contents are not lost when power is removed. Shadowing allows permanently stored information to be rapidly accessed.

**SRAM**

Static random access memory. A specific technology of making RAM which does not require periodic data refreshing.

**Status Indicator**

A display which reports the condition of some portion of your hardware. On your Computer this is an LCD screen just above the keyboard.

## Appendices

**Stereo (audio)**

A system using two channels to process sound from two different sources.

**Stroke (keyboard)**

The amount of travel of a key when it is pressed from resting to fully depressed.

**Suspend**

To make inoperative for a period of time. Your notebook uses various suspension states to reduce power consumption and prolong the charge of your battery.

**SVGA**

Super VGA.

**S-Video**

Super Video. A component video system for driving a TV or computer monitor.

**System Clock**

An oscillator of fixed precise frequency which synchronizes the operation of the system and is counted to provide time of day and date.

**TFT**

Thin Film Transistor – A technology for flat display panels which uses a thin film matrix of transistors to control each pixel of the display screen individually.

**UL**

Underwriters Laboratories – An independent organization that tests and certifies the electrical safety of devices.

**VGA**

Video Graphics Array. A video display standard originally introduced by IBM with the PS/2 series of personal computers.

**VRAM**

Video Random Access Memory. A memory dedicated to video display data and control.

**Write Protect**

Prevent alteration of the binary state of all bits in a storage media. Example: all information on a device such as a floppy diskette; a block of space in a storage media such as a partition of a hard drive; a file or directory of floppy diskette or hard drive.

**XGA**

Extended VGA.

**ZIP Drive**

A 100MB read/write removable media disk drive.

**Zoomed Video**

A PC Card port which allows notebook PCs to deliver full screen broadcast quality video through third party PC Cards, including TV tuners, video capture, and MPEG full-motion video.

---

**I n d e x**

- 3D-Stereo** . . . . . 4,49, 171,174
- AC**  
  **adapter** . . . . . 2-3,8,11-13,20-21,  
   24-29,116-117,125-126,  
   142,173, 176,179  
  **indicator** . . . . . 20-21
- Access indicators** . . . . . 21, 23-24,40
- Active-matrix display** . . . . . 179
- Adjustment feet** . . . . . 10,19,36-37,130
- Advanced menu** . . . . . 51,65-68,70-72,74,  
   76, 78,80,82-83,  
   85-86,140,156-157
- Applications** . . . . . 4,12,15,19,22,25,27,  
   39,48,116-117,123,125-126,  
   140,150, 153,156, 162-163,  
   172, 176,180, 182,184
- Arrow icon** . . . . . 21
- Audio features submenu** . . . . . 140
- Audio functions** . . . . . 66,75
- Auto suspend timeout** . . . . . 95,98
- Automatic insertion function** . . . . . 22,37,167
- Batteries** . . . . . 4,11,17-18,20-21,25-29,  
   45,53, 115,120-121, 147-152,  
   165, 167,172, 176,182
- Battery**  
  **Level indicator** . . . . . 21,28-29  
  **life** . . . . . 18,27,42-44,98, 165,  
   167, 172,176  
  **power** . . . . . 6,11,41-42
- Bay Adapter** . . . . . 2-3,7,34,115-118,  
   120-121,171,175
- Bi-directional** . . . . . 71, 171,175
- BIOS** . . . . . 60, 62,65-72,76,81-82,  
   89-90,93,101, 107,110-111,146,  
   157-161,170,174,179,183
- BIOS setup utility** . . . . . 6, 12-13,40-43,45,  
   47,51-53,55,68,89, 104,  
   140,144,153-154,163
- Block addressing** . . . . . 61,182
- Boot**  
  **booting** . . . . . 13,53, 62,74,102  
  **device** . . . . . 53,102-104  
  **from CD-ROM** . . . . . 53,62,143  
  **options** . . . . . 141,145, 158,160  
  **sector protection** . . . . . 92  
  **sequence** . . . . . 51-52,62, 138,  
   153-154,160-161
- Bridge battery** . . . . . 4,26-27,115,120-121
- Brightness** . . . . . 5-6,18,27,40,152,155,  
   167,172,176
- Cache memory** . . . . . 63,170, 173,179
- Calendar** . . . . . 56
- CapsLock** . . . . . 6,20,23
- CardBus** . . . . . 121,170-171, 173,  
   175,179

---

**I n d e x**


---

- CD**  
  **automatic insertion function** . . . 22,37,167  
  **player** . . . . . 49
- CD-ROM**  
  **access** . . . . . 21-22,141,152  
  **drive** . . . . . 2-3,6-7,17,19-22,  
   26-27,36-37,53,60, 104,  
   114-115,118,139-141,  
   143,163, 170,174  
  **holder tray** . . . . . 37
- Charging indicator** . . . . . 21,28
- Checksum** . . . . . 161
- CHS Translation** . . . . . 180
- Cigarette lighter** . . . . . 11,148,179
- Closed cover switch** . . . . . 5-6,154-155
- CMOS RAM** . . . . . 161,180
- COM Port** . . . . . 9,180
- Communication mode** . . . . . 65
- Compensation** . . . . . 33,65,78
- Conditions of use** . . . . . 3,13
- Configuration label** . . . . . 10,139
- Control panel** . . . . . 22, 31,34,39-40,  
   47-49,56,122
- CPU** . . . . . 45,47, 94-95,100, 107,153,  
   170,173,179-180,182
- CRT** . . . . . 10, 65,78,172, 175,180
- Cursor** . . . . . 4,13,30-33,42-43,55,  
   64,74,86,92,99,104
- Custom toolbar** . . . . . 43
- Data security** . . . . . 12, 52-54,87
- Date** . . . . . 52-53,56-57,107,138,185
- DC power** . . . . . 8,11,131, 135,179
- Dead battery**  
  **alarm level** . . . . . 29  
  **suspend mode** . . . . . 29, 147-148,150-151  
  **warning condition** . . . . . 45
- Default value** . . . . . 180
- Digital PBX** . . . . . 4,9,124
- DIMM** . . . . . 107,126,170,173,180
- Disk**  
  **diskette** . . . . . 57,90,104,142,  
   159,180,185  
  **drive** . . . . . 104,159  
  **errors** . . . . . 25
- Display**  
  **compression** . . . . . 156  
  **panel** . . . 5-6,17-18,23-25,33,65, 100,125
- DMA** . . . . . 61,65,68, 71,76,180
- DMA channel** . . . . . 65,71,76
- Docking** . . . . . 9-10,114,130,132-134,  
   139,142, 171,175

- Docking port** . . . . . 9,114,132
- Docking station** . . . . . 9,130,142
- Dragging** . . . . . 31,42,49
- Drive designators** . . . . . 52
- Driver** . . . . . 140,144-146, 157, 181,183
- DSVD** . . . . . 3,171,174
- ECP** . . . . . 71,171, 175,181
- ECP mode** . . . . . 71
- Electro-static discharge** . . . . . 127-128,173, 177,181
- ErgoTrac** . . . . . 4-5, 7,13,17,30-33, 44-45,74,143, 172,176
- Error message** . . . . . 13,24, 46,54, 154,158-160
- ESD** . . . . . 127-128,173, 177,181
- Ethernet** . . . . . 48,178
- Exit menu** . . . . . 51,55,64, 86,92, 99, 104,107-111
- Extended memory** . . . . . 58,129, 159,181
- External floppy disk drive** . . . . . 8,34, 52,72, 114,121, 125-126, 131,135, 170,172, 174-175,178
- External monitor** . . . . . 4,9-10,33,53,113-114, 125,131, 135,154, 157,172,175
- F1** . . . . . 33,54-55,160,172,176
- F10** . . . . . 33,55,125,154,157
- F2** . . . . . 13,52-54,128,153,160
- F5** . . . . . 33,55
- F9** . . . . . 55
- Faulty battery** . . . . . 27
- Fax** . . . . . 3-4,15,44,48,50, 121, 138,162, 171,174
- FCC** . . . . . 178,181
- Feet** . . . . . 10,19, 36-37,130, 173,177
- File transfers** . . . . . 4,48,50
- Fixed disk** . . . . . 90-91,159-160
- Floppy disk drive** . . . . . 2-3,6-8, 17,20, 23-24,34-36,52, 57,72, 113-116,121,125-126,131, 135,139, 142,159-160, 163, 170, 172-175,177-178
- Floppy disk drive access indicator** . . . . . 23,35
- Floppy disk format** . . . . . 34,53,62
- Fn** . . . . . 32-33,53,125,154, 157,172,176
- Function keys** . . . . . 32-33,172,176
- Gigabyte** . . . . . 181
- Half duplex** . . . . . 71

---

**I n d e x**


---

- Hard disk** . . . . . 42,44,47,60-62, 94,98,119  
**Hard disk timeout** . . . . . 47,94,98  
**Hard drive**  
    **access** . . . . . 22,47, 172-173, 176,180  
    **access indicator** . . . . . 22  
    **format** . . . . . 53,62  
**Hardware data security** . . . . . 12  
**Hardware security passwords** . . . . . 12  
**Hardware volume control** . . . . . 34,49  
**Head** . . . . . 61,179-180  
**Headphones** . . . . . 8,113-114, 124,140  
**Hexadecimal** . . . . . 69,75,181  
**Icon** . . . . . 14-15,21-22,26, 28,31, 38,42,47, 50,56,152  
**IDE** . . . . . 66,72, 121,181  
**Idle Mode** . . . . . 47, 94,98,100  
**Impedance** . . . . . 171, 174,181  
**Inactivity shutoff** . . . . . 94  
**Inactivity suspension** . . . . . 95  
**Infrared** . . . . . 4,9-10,17, 48,50, 171, 174,181-182  
**Internal hard drive** . . . . . 22,39,41, 44,46, 62,90, 111,153  
**Internal modem** . . . . . 3-4,9,17, 40,48, 50,80,114,124, 162,171,175  
**Interrupt level** . . . . . 65  
**IR** . . . . . 181  
**IrDA** . . . . . 4,10, 48,70,171, 174,182  
**IRQ** . . . . . 69-72,76,80-82,182  
**joystick** . . . . . 44-45,66, 75-76,131,178  
**K56flex** . . . . . 3,48, 171,175  
**Keyboard** . . . . . 4-5,7-8,10, 17,19, 23-24,30, 32-33,40,47, 50,66,73-74,88, 113-114, 125,131-135,139,143-144, 150,155-156,160,171-172, 175-176,178,183-185  
**Kilobyte** . . . . . 58, 107,182  
**Label** . . . . . 10, 15,34,37-38, 123,139-140  
**LAN** . . . . . 26,28,121, 152,182  
**LANdock** . . . . . 113,130-133,142,144,178  
**LBA** . . . . . 61,180,182  
**LBA mode control** . . . . . 61  
**LCD** . . . . . 6,100, 156,172, 175,182,184  
**License agreement** . . . . . 13-14

- Lithium ion battery** . . . . . 2-3,7,11-12,20,  
24,26-28,41,114-116,  
120,172,176,178,182
- Low battery alarm** . . . . . 29,150
- LPT port** . . . . . 10,182
- Main menu** . . . . . 51,53-54,56-59,  
63-64,128-129,141-144,  
153,158
- Manuals** . . . . . 15
- Maximum battery life** . . . . . 18,42-43, 167
- Maximum capacity** . . . . . 61
- Maximum performance** . . . . . 42-43
- Megabyte** . . . . . 58,107, 129,182
- Megahertz** . . . . . 182
- Memory**
  - cache . . . . . 58,63-64
  - capacity . . . . . 10,34, 126,128-129
  - upgrade compartment . . . . . 10,126-127
  - upgrade module . . . . . 10,46, 111,  
113-114,126-129,  
144,159
- MHz** . . . . . 107,182
- Microphone** . . . . . 4-6,8,34,50, 113-114,  
124,171-172,  
174-175,178
- MIDI** . . . . . 49,66,131,178,182-183
- MMX technology** . . . . . 3,170, 173,182
- Modem** . . . . . 3-4,9,15,17,26,40,42,  
44,47-48,50,80,97, 114,  
121,124, 137,139, 145,152,  
162,171, 174-175,182-183
- Monaural** . . . . . 171,174,183
- Monitor** . . . . . 4, 9-10,33,53,113-114,  
125,131, 135,154, 157,160,  
172,175, 178,185
- Mono microphone** . . . . . 4,8,114, 124,171-  
172,174-175
- Mouse** . . . . . 7-8, 30-33,38,66,73-74,  
88,100,113-114,125,  
131-135,139, 143-144,  
171-172, 175-176,178
- Mouse cursor** . . . . . 31,74
- MPEG file player** . . . . . 49
- MPEG-1** . . . . . 4,171,175
- MPU-401** . . . . . 183
- Multi-function bay** . . . . . 2-3, 5-7,10-11,  
20, 28,34,38,53, 113,  
115-121,149,151
- Multi-sector** . . . . . 61
- Multimedia device** . . . . . 66,75-76

---

**I n d e x**

- NTSC** . . . . . 183  
**Numeric keypad** . . . . . 8,23, 32-33,114,  
 171-172,175-176  
**NumLk** . . . . . 6,20,23,33  
**NVRAM** . . . . . 160  
**Operating system** . . . . . 4,12-13,15,24-25,  
 34-35,38-39,47,51-54,  
 56,66,90,92, 101-104,  
 110, 120,133,135,140-141,  
 143-144,153, 157-160,  
 162-163, 179-181,183-184  
**Output only** . . . . . 71, 171,175  
**PAL** . . . . . 183  
**Parallel port** . . . . . 9-10,65, 71-72,113-114,  
 124,131,135,145,183  
**Parity** . . . . . 160  
**Partition** . . . . . 183,185  
**Password** . . . . . 12,39,54,88-91,143,153,158  
**Password on boot** . . . . . 88,90  
**PC card** . . . . . 4,6-7, 20,23-24,41,  
 47,50,97,114,121-123,  
 131,133,139,146, 152,  
 159, 171,175, 179,185  
**PC card access indicator** . . . . . 23  
**PC-Doctor** . . . . . 4,139  
**PCMCIA** . . . . . 171, 175,183  
**Peripheral device** . . . . . 183  
**Peripherals** . . . . . 170,180,182  
**PHDISK** . . . . . 46  
**PIO** . . . . . 61,183  
**Pitch** . . . . . 172,176,183  
**Pixel** . . . . . 33,78,156, 172,175,  
 179,183,185  
**Plug & Play** . . . . . 65-66  
**Pointing device** . . . . . 4-5, 7,13,17,30-31,  
 33,74,143,172,176  
**Port replicator** . . . . . 9,113,131-132,  
 134-135,178  
**POST** . . . . . 24, 52,54,60,90,129,  
 145,154-155,183  
**.**

<b>Power</b>		
<b>adapter</b> . . . . .	20,27,29, 42,44, 120,127,147-152	
<b>indicator</b> . . . . .	19,29,41	
<b>management</b> . . . . .	4,6,17,26-27, 29,40-44,47,51-53, 88,90,93,150, 155-156,167, 172-173,176	
<b>On Self Test</b> . . . . .	24,52,54,90, 102, 129, 137,145, 154-155, 159-161,183	
<b>savings</b> . . . . .	6,40-45,47, 94,98, 150,152,155,173,176	
<b>source</b> . . . . .	24, 29,45,138,149,151	
<b>switch</b> . . . . .	8,19-21,23-26, 29, 44,52, 88,96,115, 123, 127-128,132-133,138, 143,147-151,161	
<b>PowerPanel</b> . . . . .	4,28,40-45,47, 53,93, 150,152, 155,171	
<b>PowerPanel toolbar</b> . . . . .	28, 42-43,45	
<b>Pre-installed software</b> . . . . .	4,13,15, 17,39, 49,137, 163, 171,175	
<b>Presentation profile</b> . . . . .	43	
<b>Product code</b> . . . . .	14	
<b>Program</b> . . . . .	43,49-50,53-54, 139, 161,179,181,183-184	
<b>Quiet boot</b> . . . . .	52	
<b>RAM</b> . . . . .	3,121,129, 159,161, 170,174, 179-180,184	
<b>Real time clock</b> . . . . .	161	
<b>Recovery CD-ROM</b> . . . . .	2,15,39,163	
<b>Registration</b> . . . . .	1-2,15,26	
<b>Reset</b> . . . . .	12,52-53, 84,163,184	
<b>Restart</b> . . . . .	14,22,25,34,45,47-48, 52,54,88,133,135,143-146, 149,159, 163,184	
<b>Resume</b> . . . . .	5-6,19,21, 25,29,40-41, 44-47, 88,90, 96-97,100, 132,143,149-150,152, 155-156,160,184	
<b>Resume on time</b> . . . . .	97	
<b>RJ-11</b> . . . . .	2,9,114,124, 131,133, 135,172, 175,178	
<b>RJ-45</b> . . . . .	131,178	
<b>ROM</b> . . . . .	170,174, 179,184	
<b>S-Video</b> . . . . .	185	
<b>Save-to-disk file allocation</b> . . . . .	40, 46,51, 111,163	
<b>Save-to-disk mode</b> . . . . .	19,40-41,44-46, 90,96-97	
<b>Scr Lk Indicator</b> . . . . .	23	
<b>SCSI</b> . . . . .	121,184	
<b>SDRAM</b> . . . . .	3,107, 126,170, 173-174,184	

---

**I n d e x**


---

- Second lithium ion battery** . . . . . 3,12,20,24,  
26,28,114
- Sectors** . . . . . 60-61
- Security** . . . . . 12,51-55,87-92,  
125,142-143, 153,  
157, 173,177
- Security menu** . . . . . 12, 51,87,89-92,  
143,153
- Serial port** . . . . . 9,70-71,100, 113-114,  
124, 131,135, 145,184
- Setup utility** . . . . . 6,12-13,24,40-43,  
45,47,51-56,58-59,63-65,  
68, 73,75,77,79, 81,83,85-87,  
89,92-93,99,103-104,109-111,  
128,140-144,150,152-155,  
158-161,163
- Shadow RAM** . . . . . 161,184
- Shortcut menu.** . . . . . 33
- Shorted batteries.** . . . . . 28
- Shutdown** . . . . . 14, 25-26,29,52,  
123, 133,139,  
143,152
- Software data security.** . . . . . 12
- Software security feature** . . . . . 12
- Software volume control** . . . . . 8,34
- Speaker.** . . . . . 4,7-8,171,174
- Speakerphone** . . . . . 4,34,44,48,50
- SRAM** . . . . . 114, 121,159,  
170,173,184
- Standby mode** . . . . . 44,47,155
- Standby timeout.** . . . . . 95,98
- Start menu** . . . . . 14,26,33,43,45,49-50,  
52, 133,143
- Status indicator.** . . . . . 5-6, 17,19-20,26,  
28-29,40,96,  
147-152,184
- Stereo.** . . . . . 4,7-8, 49,113-114,124,  
171-172,174-175,  
178,185
- Stereo headphones** . . . . . 124
- Stereo line in.** . . . . . 4,8,113-114,  
124,171-172,  
174-175,178
- Stroke.** . . . . . 172,176,185
- Supervisor password.** . . . . . 89-90
- Support representative** . . . . . 10,27, 46,50,  
88,121,138-139,  
154-156,159-161,  
166
- Suspend** . . . . . 5-6,12,19,21,23,25-29,  
40-42,44-47,88,90,95-98,  
100,115, 120-121,123, 130,  
132-133, 143,147-152, 155-156,  
172-173, 176,185

<b>Suspend mode</b> . . . . .	<b>6,12, 19,23,26-29, 40-41,44-45,95,97,100, 115,120-121,123,130, 133,143,147-148,150-151, 155,172-173,176</b>	<b>Tilt Adjustment Feet.</b> . . . . .	<b>10</b>	<b>USB</b>	
<b>SVGA</b> . . . . .	<b>10, 172,175, 178,185</b>	<b>Time.</b> . . . . .	<b>13-14,24,26,28,31,33, 37,39,45-46, 52-53,56-57, 94-95,97,116, 119-121, 125, 128,132-134, 153-155, 161, 166,172-173, 176, 179-180,184-185</b>	<b>device</b> . . . . .	<b>4,139,145</b>
<b>System</b>		<b>Transfer mode</b> . . . . .	<b>61</b>	<b>port</b> . . . . .	<b>8,114,124</b>
<b>battery.</b> . . . . .	<b>161</b>	<b>Troubleshooting.</b> . . . . .	<b>24,54, 129, 137-139,141,143, 145, 147, 149,151, 153,155, 157,159, 161,163</b>	<b>User input</b> . . . . .	<b>94-95</b>
<b>clock.</b> . . . . .	<b>185</b>	<b>Tutorials</b> . . . . .	<b>15</b>	<b>User password</b> . . . . .	<b>89</b>
<b>date</b> . . . . .	<b>56-57</b>	<b>TV</b> . . . . .	<b>183,185</b>	<b>User registration</b> . . . . .	<b>1</b>
<b>error</b> . . . . .	<b>24, 133,135</b>	<b>UL</b> . . . . .	<b>178,185</b>	<b>VCR</b> . . . . .	<b>49</b>
<b>memory</b> . . . . .	<b>10,44-46,58,95-97, 128-129,161, 170, 173,181</b>	<b>Unauthorized access.</b> . . . . .	<b>12</b>	<b>Vehicle</b> . . . . .	<b>11</b>
<b>time.</b> . . . . .	<b>56-57</b>	<b>Universal Serial Bus.</b> . . . . .	<b>8,114, 172,175</b>	<b>VGA.</b> . . . . .	<b>10,172, 175, 178,185</b>
<b>timer</b> . . . . .	<b>161</b>			<b>Video</b> . . . . .	<b>3-4,33, 42-43,45,47, 49,66, 77-78,94,98-100, 114,121-122,125,139,154-157, 161,170-171, 174-175, 178, 182,185</b>
<b>Telephone</b> . . . . .	<b>4,9,15,26,97,113-114, 124,130, 134,172, 175,178</b>			<b>Video timeout.</b> . . . . .	<b>43,47,94,98, 100,155</b>
<b>TFT</b> . . . . .	<b>185</b>			<b>Virus.</b> . . . . .	<b>4,14,49</b>
<b>Theft prevention lock</b> . . . . .	<b>8,113,125,173,177</b>			<b>Voice</b> . . . . .	<b>3,48,50,171,174</b>

<b>VRAM</b> . . . . .	<b>185</b>
<b>Windows</b> . . . . .	<b>2,4,7,13-15,19-20, 22,24-26,31-33,39-41, 43-49,52,56, 85-86,123, 133,141,149,159, 167, 171-172, 175-176,179</b>
<b>Windows setup</b> . . . . .	<b>159</b>
<b>Windows taskbar</b> . . . . .	<b>123</b>
<b>Write protect</b> . . . . .	<b>35,39,90,185</b>
<b>XGA</b> . . . . .	<b>178,185</b>
<b>Zip drive</b> . . . . .	<b>3-4,6,17,20, 22,24, 27, 38,53,114-116,119, 139,157-158, 162, 167,171,174,185</b>
<b>Zoomed video</b> . . . . .	<b>4,114,121, 171, 175, 178,185</b>

# Other ManualsLib Projects



[www.manualslib.com](http://www.manualslib.com)



[www.manualslib.de](http://www.manualslib.de)



[www.manualslib.es](http://www.manualslib.es)



[www.manualslib.fr](http://www.manualslib.fr)



[www.manualslib.nl](http://www.manualslib.nl)



[www.manualslib.mx](http://www.manualslib.mx)



[www.manualslib.tech](http://www.manualslib.tech) 30+ Languages